

CONTENTS

Scope of This Manual	5
Typographic Conventions	5
Unpacking and Inspection	5
Safety	5
Terminology and Symbols	5
Considerations	5
Introduction.	6
Dimensions	6
Operation	7
Keypad Operation on the Home Screen	7
Keypad Operation in the Menu Structure	7
Selecting an Option in a Parameter Selection List	8
Entering a Number	8
Installation.	9
Overview	9
Installation Considerations	9
Equipment Required	9
Installing the Transducers	9
Installing a Meter with a Remote Transmitter and Fixed Transducers	10
Installing a Meter with a Remote Transmitter and Adjustable Transducers	11
Installing a Meter with an Integral Transmitter	12
Wiring the Transmitter	13
Wiring the Transducer.	13
Initial Meter Setup	18
Menu Map	19
Parameter Descriptions by Menu	20
Main Menu Structure	20
Setup > Units	20
Setup > Meter.	21
Setup > Meter > Pipe	22
Setup > Meter > Spacing.	23
Setup > Meter > Flow Setup.	23
Setup > Meter > Shunt	25

Setup > Meter > Calibration	26
Setup > Input/Output >Current Output	27
Setup > Inputs/Output > Output #1 (or Output #2)	28
Setup > Inputs/Output >Input	29
Setup > Communications	30
Setup > Passcode Setup	31
Display Menu	32
Information Menu	32
Diagnostics Menu	33
Reset Menu	33
Troubleshooting	34
Out of Specification Messages	34
Error Messages	34
Check Function Codes	34
Warning and Alarm Message Codes	35
Symptoms	37
Front Panel Replacement	38
Main Board Replacement	38
Specifications	40
System	40
Transmitter	40
Transducers	41
Configuration Software	41
Part Number Construction	42
North American Pipe Schedules	44

SCOPE OF THIS MANUAL

This manual is intended to help you get the TFX-500w meter up and running quickly. Read this manual carefully before attempting any installation or operation. Keep the manual accessible for future reference.

Typographic Conventions

- In step-by-step instructions, **bold** text indicates items on the screen you need to select or act upon.
Example: Click the **Setup** menu.
- Names of parameters, options, boxes, columns and fields are *italicized*.
Example: The value displays in the *Status* field.
- Messages and special markings are shown in quotation marks.
Example: "Error" displays in the title bar.
- In most cases, software screen text appears in the manual as it does on the screen. For example, if a word is capitalized on the screen, it is capitalized when referred to in the manual.

UNPACKING AND INSPECTION

Upon opening the shipping container, visually inspect the product and applicable accessories for any physical damage such as scratches, loose or broken parts, or any other sign of damage that may have occurred during shipment.

NOTE: If damage is found, request an inspection by the carrier's agent within 48 hours of delivery and file a claim with the carrier. A claim for equipment damage in transit is the sole responsibility of the purchaser.

SAFETY

Terminology and Symbols



Indicates a hazardous situation, which, if not avoided, is estimated to be capable of causing death or serious personal injury.



Indicates a hazardous situation, which, if not avoided, could result in severe personal injury or death.



Indicates a hazardous situation, which, if not avoided, is estimated to be capable of causing minor or moderate personal injury or damage to property.

Considerations

- The installation of the TFX-500w meter must comply with all applicable federal, state, and local rules, regulations, and codes.
- Do not use sharp objects when operating the device (such as using a pen to press buttons on the keypad).
- When the TFX-500w meter is a part of a system, it is configured in a fail-safe operation so that if the transmitter signal is compromised, the TFX-500w meter will not cause harm to the system.



THIS PRODUCT IS FOR USE ONLY WITH WATER, NOT FOR USE IN HAZARDOUS LOCATION APPLICATIONS.



CE PRODUIT NE DOIT ÊTRE UTILISÉ QU'AVEC DE L'EAU ET NE DOIT PAS ÊTRE UTILISÉ DANS DES ENDROITS DANGEREUX.

IMPORTANT

Not following instructions properly may impair safety of equipment and/or personnel.

INTRODUCTION

The TFX-500w ultrasonic transit time flow meter measures volumetric flow of clean water in pipes 10 in. or smaller. By clamping on the outside of the pipe, the ultrasonic meter installs without cutting or tapping the pipe.

Transit time flow meters use two transducers that clamp on to the outside of a pipe and never directly contact the fluids. The transducers function as both ultrasonic transmitters and receivers. The flow meters operate by alternately transmitting and receiving a frequency-modulated burst of sound energy between the two transducers. The burst is first transmitted in the direction of fluid flow and then against fluid flow. Sound energy in a moving liquid is carried faster when it travels in the direction of fluid flow (downstream) than it does when it travels against fluid flow (upstream). The sound's time is accurately measured in both directions.

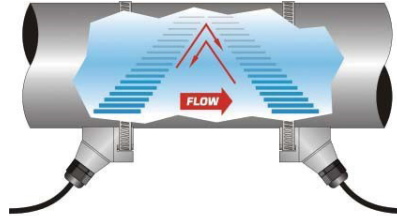
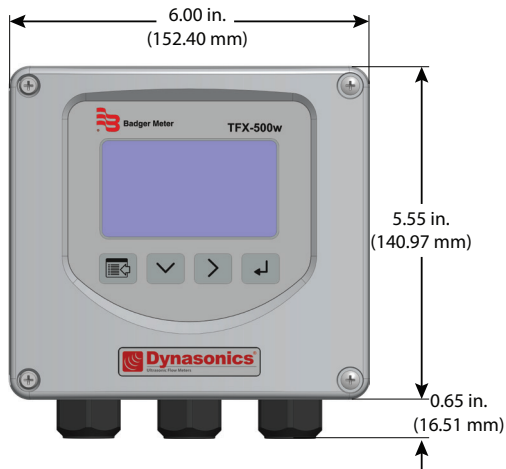

Figure 1: Meter operation

DIMENSIONS

Enclosure, Integral and Remote, Front View



Integral Enclosure Side View



Remote Enclosure Side View

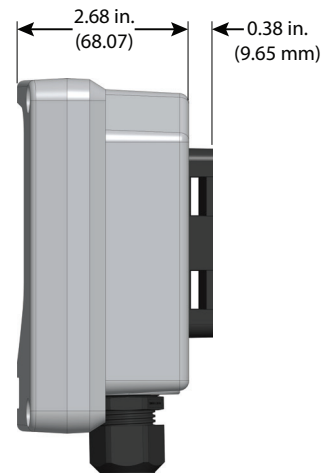





Figure 2: Dimensions

OPERATION

Keypad Operation on the Home Screen



-  The *MENU/BACK* key enters menu structure.
-  The *DOWN ARROW* key toggles between flow rate, flow total, velocity and flow rate with flow total.
-  The *RIGHT ARROW* key has no function.
-  The *ENTER* key has no function.

Keypad Operation in the Menu Structure

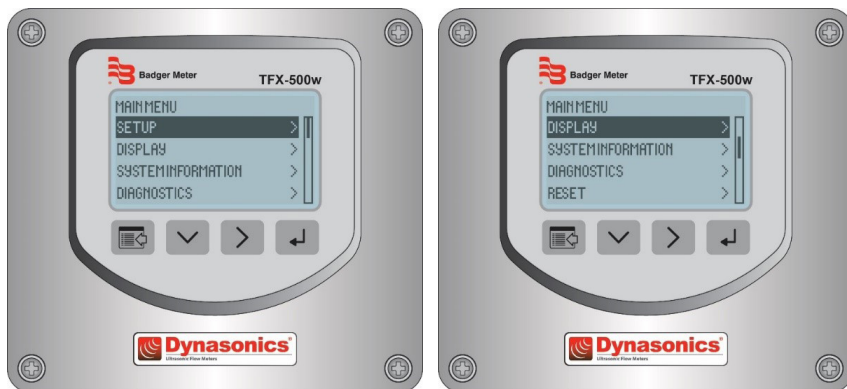

The cursor bar highlights the submenu or parameter that will be viewed or edited. The scroll bar on the right indicates the relative position the cursor bar is at on the list when there are more than 4 items.

- *MENU/BACK* returns to parent menu (up a level). If at the *Main* (top level) menu, returns to the *Home Screen*.
- *DOWN ARROW* scrolls the list.
- *RIGHT ARROW* and *ENTER* have the same function in the menu structure and advance to the submenu or to read/edit a parameter.

Selecting an Option in a Parameter Selection List

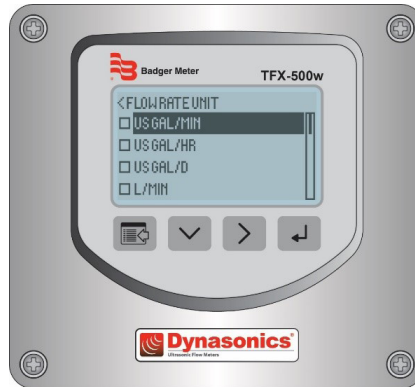

The active option in the parameter list has a filled-in box on the left side. The scroll bar on the right indicates the relative position the cursor bar is at on the list when there are more than 4 items.

- *DOWN ARROW* scrolls the list.
- *RIGHT ARROW* and *ENTER* have the same function in the parameter selection list. Pressing either of these buttons selects the option and the box on the left side fills in to show the item is selected.
- *MENU/BACK* exits parameter editing and returns to the parent menu (up a level).

Entering a Number



The parameter name and current value is displayed in the top portion of the screen. Edit the number on the bottom right of the screen.

- *MENU/BACK* exits parameter editing and returns to parent menu (up a level). The parameter remains at the value displayed in the top portion of the screen.
- *DOWN ARROW* cycles through the numbers and other options.
- *RIGHT ARROW* moves the cursor to the right. Once it reaches the rightmost digit or a space, the cursor moves to the leftmost digit.
- *ENTER* accepts the value.

INSTALLATION

Overview

Each of the installation steps that follow is explained in detail on *page 10* through *page 12*. The actual installation procedures differ slightly, depending on whether the transducers are *fixed* or *adjustable*.

If the transducers are *fixed*, you will:

1. Install the transducers.
2. Install the transmitter.
3. Wire the transmitter.
4. Program the meter.

If the transducers are *adjustable*, you will:

1. Install the transmitter.
2. Wire the transmitter.
3. Set up the meter (select the optimum transmission mode, enter the site information, and enter the fluid and pipe properties).
4. Install the transducers.
5. Complete the meter programming.

Installation Considerations

Mount the transmitter in a location:

- Where little vibration exists.
- That is protected from corrosive fluids.
- That is within the transmitters ambient temperature limits: With display, $-4...140^{\circ}\text{F}$ ($-20...60^{\circ}\text{C}$); without display: $-40...158^{\circ}\text{F}$ ($-40...70^{\circ}\text{C}$).
- That is out of direct sunlight. Direct sunlight may increase transmitter temperature to above the maximum limit.

Equipment Required

- Screwdrivers, wide blade and tiny blade (for securing wires to the terminal blocks)
- User manual for the transducers
- Four #8 or M4 screws, if mounting the transmitter on a wall
- Stainless steel banding straps, if mounting the transmitter on a pipe

Installing the Transducers

See the user manual for your particular transducer for installation instructions.

Installing a Meter with a Remote Transmitter and Fixed Transducers

- Locate the transmitter within the length of the transducer cables supplied or exchange the cable for one of proper length.
- See *Figure 2 on page 6* for enclosure and mounting dimension details. Allow enough room for door swing, maintenance and conduit entrances.

IMPORTANT

When routing wires to the transmitter, make sure the cables are not twisted, pinched or hanging loosely.

1. Install the *fixed* transducers according to instructions in the transducer user manual.
2. Partially loosen the 2 enclosure captive screws on the left side of the transmitter cover. Completely loosen the 2 screws on the right side. Grasp and lift the cover and open it to the left. The cover remains attached and the left screws act as a hinge.

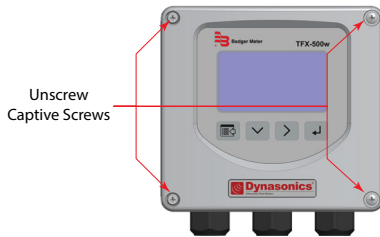

Figure 3: Captive cover screws

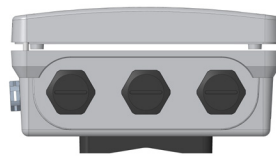

Figure 4: Lift cover from base

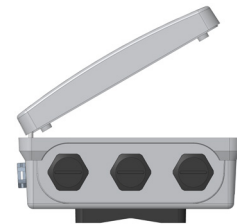

Figure 5: Open cover to the left

3. Unscrew the wingnut from the threaded stud on the inside back of the enclosure to release the adapter plate. Set aside the wingnut.

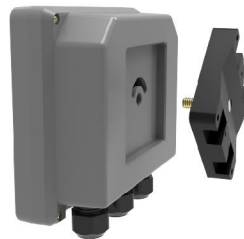

Figure 6: Rotatable adapter plate

4. If necessary, rotate the adapter plate by 90° to accommodate the final orientation of the transmitter.
5. Mount the adapter plate either to a wall (with 4 customer-supplied #8 or M4 screws) or to a pipe (with mounting straps).

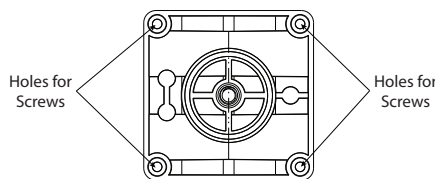

Figure 7: Wall mount

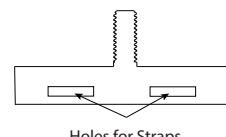

Figure 8: Pipe Mount

6. Use conduit holes where cables enter the enclosure from the bottom. Use plugs to seal any holes that are not used for cable entry. A cable gland kit is included for inserting the transducer and power cables.

NOTE: Use NEMA 4 (IP-66) rated fittings/plugs to maintain the watertight integrity of the enclosure. Generally, the right conduit hole (viewed from front) is used for power, the left conduit hole for transducer connections, and the center hole is used for I/O wiring.

7. Install the wires through the gland nuts and connect the wires to the removable terminal blocks. See *“Wiring the Transmitter” on page 13*.
8. Wire the transducers to the transmitter.
9. Slide the meter enclosure over the threaded stud and secure it with the wingnut.
10. Plug the wired terminal blocks into the main board.
11. Reassemble the cover.
12. Set up the meter. See *“Initial Meter Setup” on page 18* for instructions.

Installing a Meter with a Remote Transmitter and Adjustable Transducers

- Locate the transmitter within the length of the transducer cables supplied or exchange the cable for one of proper length.
- See *Figure 2 on page 6* for enclosure and mounting dimension details. Allow enough room for door swing, maintenance and conduit entrances.

IMPORTANT

When routing wires to the transmitter, make sure the cables are not twisted, pinched or hanging loosely.

1. Partially loosen the 2 enclosure captive screws on the left side of the transmitter cover. Completely loosen the 2 screws on the right side. Grasp and lift the cover and open it to the left. The cover remains attached and the left screws act as a hinge.

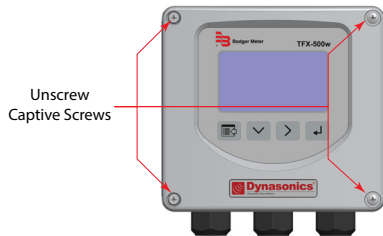

Figure 9: Captive cover screws



Figure 10: Lift cover from base



Figure 11: Open cover to the left

2. Unscrew the wingnut from the threaded stud on the inside back of the enclosure to release the adapter plate. Set aside the wingnut.



Figure 12: Rotatable adapter plate

3. If necessary, rotate the adapter plate by 90° to accommodate the final orientation of the transmitter.
4. Mount the adapter plate either to a wall (with 4 customer-supplied #8 or M4 screws) or to a pipe (with mounting straps).

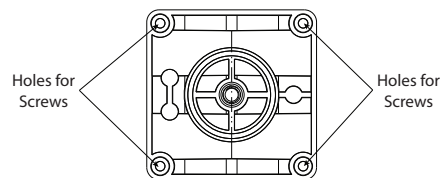

Figure 13: Wall mount

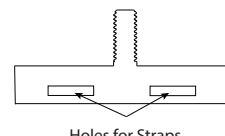

Figure 14: Pipe Mount

5. Use conduit holes where cables enter the enclosure from the bottom. Use plugs to seal any holes that are not used for cable entry. A cable gland kit is included for inserting the transducer and power cables.

NOTE: Use NEMA 4 (IP-66) rated fittings/plugs to maintain the watertight integrity of the enclosure. Generally, the right conduit hole (viewed from front) is used for power, the left conduit hole for transducer connections, and the center hole is used for I/O wiring.

6. Install the wires through the gland nuts and connect the wires to the removable terminal blocks. See *“Wiring the Transmitter” on page 13*.
7. Set up the meter. See *“Initial Meter Setup” on page 18* for instructions.
8. Install the *adjustable* transducers according to instructions in the transducer user manual.
9. Wire the transducers to the transmitter.
10. Slide the meter enclosure over the threaded stud and secure it with the wingnut.
11. Plug the wired terminal blocks into the main board.
12. Reassemble the cover.

Installing a Meter with an Integral Transmitter

1. Install the meter on the pipe according to the instructions in the user manual for your particular transducer.

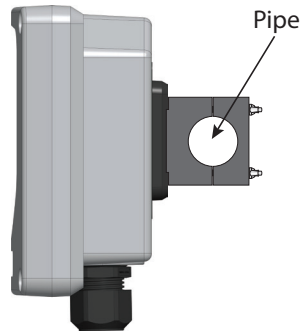

Figure 15: Install the meter onto the pipe

2. Partially loosen the 2 enclosure captive screws on the left side of the transmitter cover. Completely loosen the 2 screws on the right side. Grasp and lift the cover and open it to the left. The cover remains attached and the left screws act as a hinge.
 3. If necessary, rotate the transmitter 180° by opening the cover, loosening the wing nut, repositioning the transmitter, and reinstalling all of the connections.
 4. Use conduit holes where cables enter the enclosure from the bottom. Use plugs to seal any holes that are not used for cable entry. A cable gland kit is included for inserting the transducer and power cables.
- NOTE:** Use NEMA 4 (IP-66) rated fittings/plugs to maintain the watertight integrity of the enclosure. Generally, the right conduit hole (viewed from front) is used for power, the left conduit hole for transducer connections, and the center hole is used for I/O wiring.
5. Install the wires through the gland nuts and connect the wires to the removable terminal blocks. See *“Wiring the Transmitter” on page 13.*
 6. Plug the wired terminal blocks into the main board.
 7. Reassemble the cover.

WIRING THE TRANSMITTER

IMPORTANT: Select field wiring means rated for 5° C above the maximum area temperature when it is possible that the temperature will exceed 55° C.

To access terminal strips for wiring, loosen the 4 enclosure captive screws. Grasp and lift the cover and open it to the left. The cover remains attached and the left screws act as a hinge.

Electrical Symbols

Function	Direct Current	Alternating Current	Earth (Ground)	Protective Ground	Chassis Ground
Symbol					

Figure 16: Electrical symbols

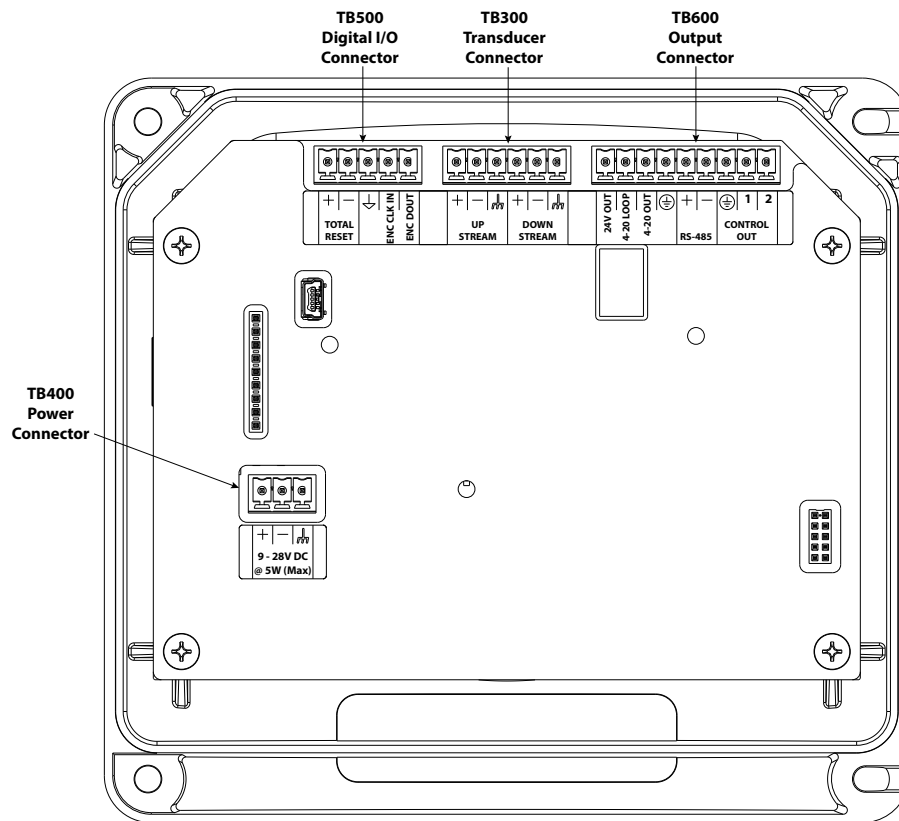

Figure 17: Wiring connectors

Wiring the Transducer

1. Guide the transducer terminations through the transmitter conduit hole in the bottom-left of the enclosure.
2. Secure the transducer cable with the supplied conduit nut (if flexible conduit was ordered with the transducer).
3. The terminals within the transmitter are screw-down barrier terminals. Connect the wires at the corresponding screw terminals in the transmitter. Observe upstream and downstream orientation and wire polarity. See *Figure 18*.

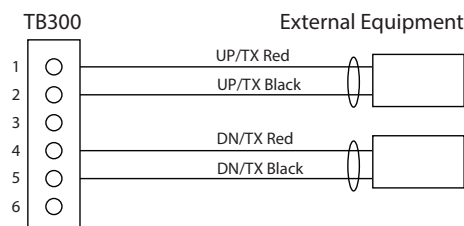

Figure 18: Upstream/downstream transducer

NOTE: Transducer cables have two wire-color combinations. For the blue and white combination, the blue wire is positive (+) and the white wire is negative (-). For the red and black combination, the red wire is positive (+) and the black wire is negative (-). The transducer wires are labeled to indicate which pair is upstream or downstream.

4. Connect power to the screw terminal block in the transmitter using the conduit hole in the center of the enclosure. Use wiring practices that conform to local and national codes such as The National Electrical Code Handbook in the U.S.

CAUTION

ANY OTHER WIRING METHOD MAY BE UNSAFE OR CAUSE IMPROPER OPERATION OF THE TRANSMITTER.

NOTE: This transmitter requires clean electrical line power. Do not operate this transmitter on circuits with noisy components (such as fluorescent lights, relays, compressors, or variable frequency drives). Do not use step-down transformers from high voltage, high amperage sources. Do not to run signal wires with line power within the same wiring tray or conduit.

DC Power Connections

The transmitter may be operated from a 9...28V DC source, as long as the source supplies a maximum of 5 Watts of power. Connect the DC power to 9...28V DC In, power ground, and chassis ground, as in *Figure 19*.

NOTE: DC-powered transmitters are protected from major catastrophe with an internal 1.5 Amp SLO-BLO fuse. If this fuse is blown, the transmitter must be inspected and the fuse replaced at the factory.

IMPORTANT: A Class II DC power supply is required.

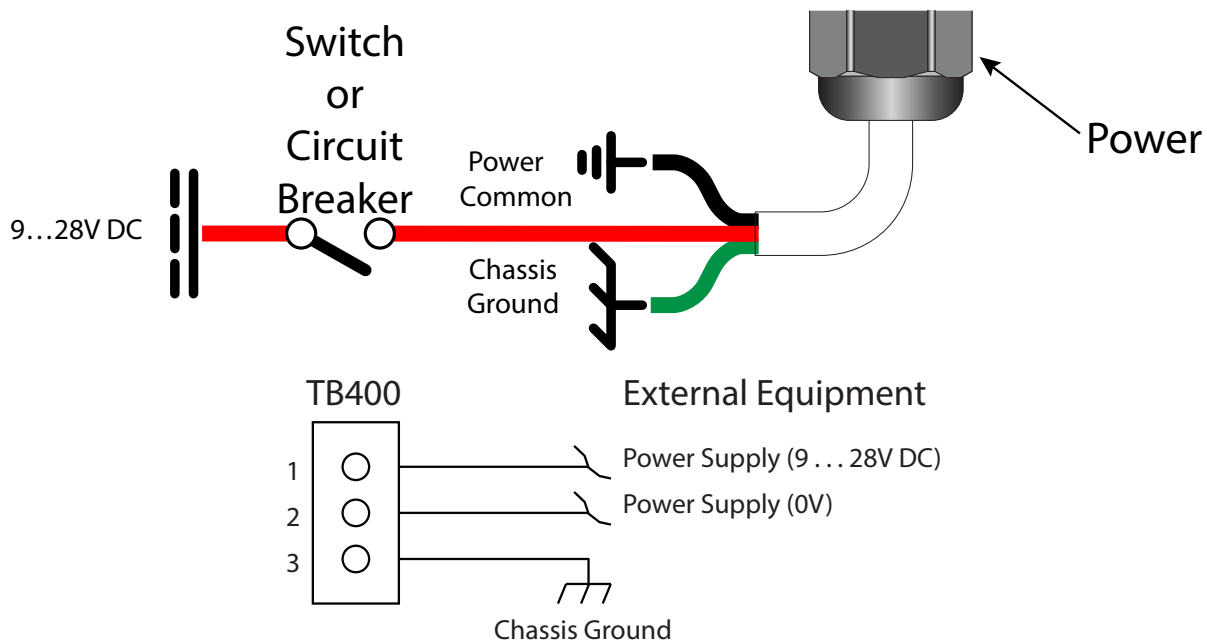

Figure 19: DC power connections

4...20 mA Output Wiring

The 4...20 mA output transmits an analog current signal that is proportional to system flow rate. The 4...20 mA output can be internally or externally powered and can span negative to positive flow rates.

DC-powered transmitters use the DC power supply voltage to drive the current loop. The current loop is not isolated from DC ground or power.

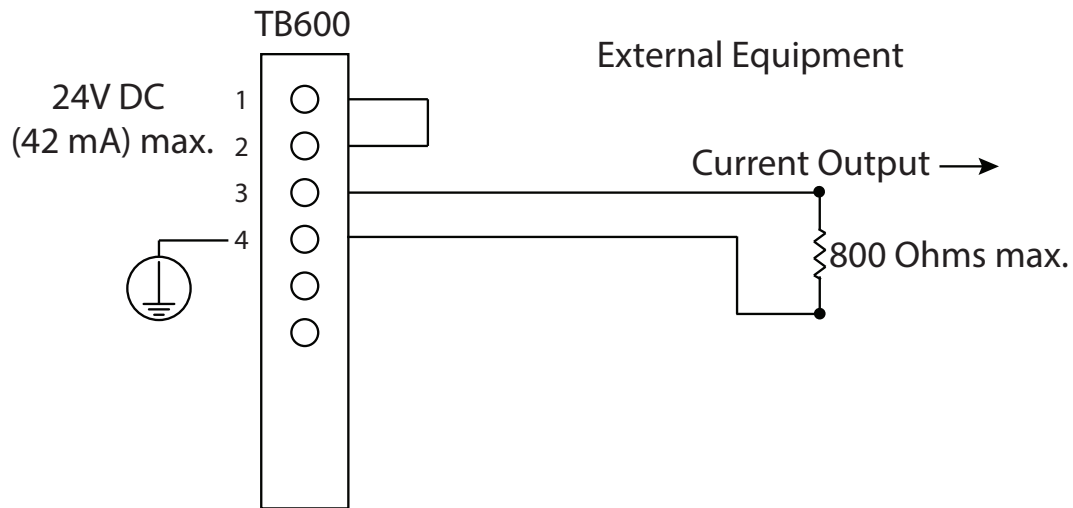

Figure 20: Typical 4...20 mA interface using internal isolated 24V DC source

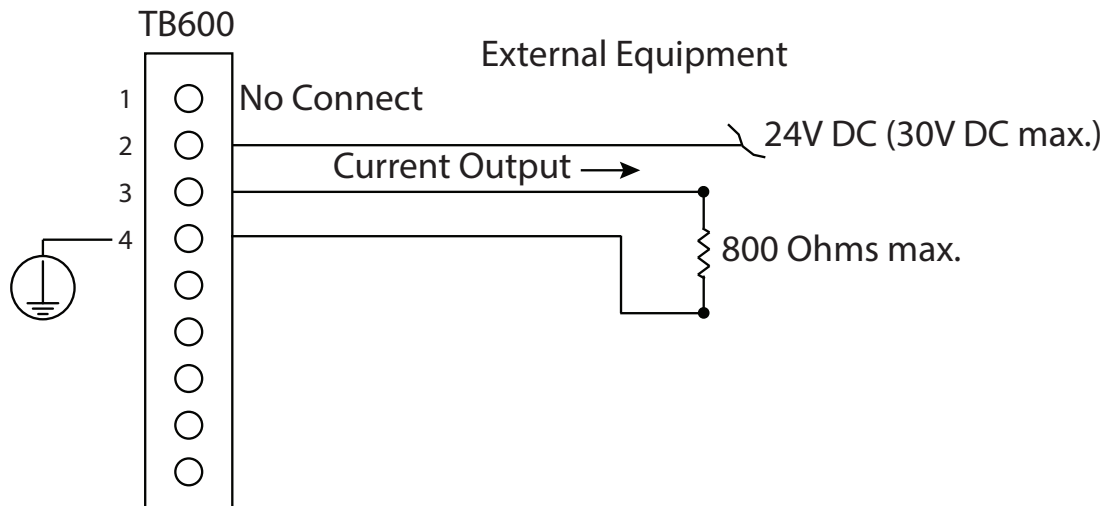

Figure 21: Typical 4...20 mA interface using external isolated 24V DC source

Digital Outputs Wiring

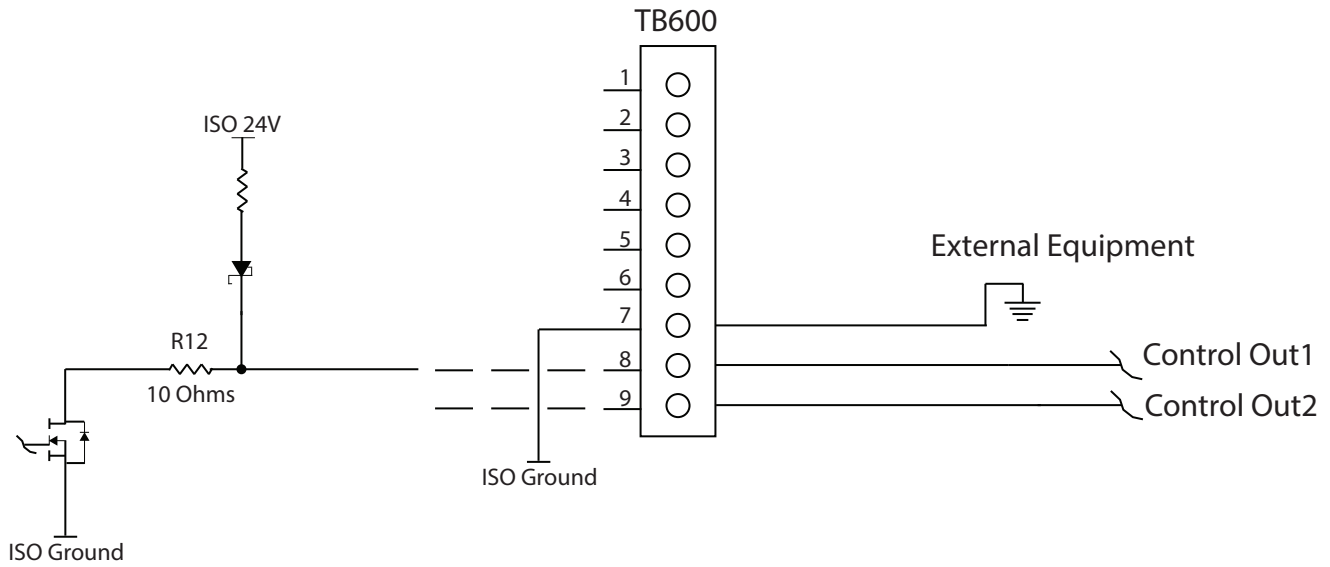

Figure 23: Typical control out 1 & 2 interface with internal pullups active

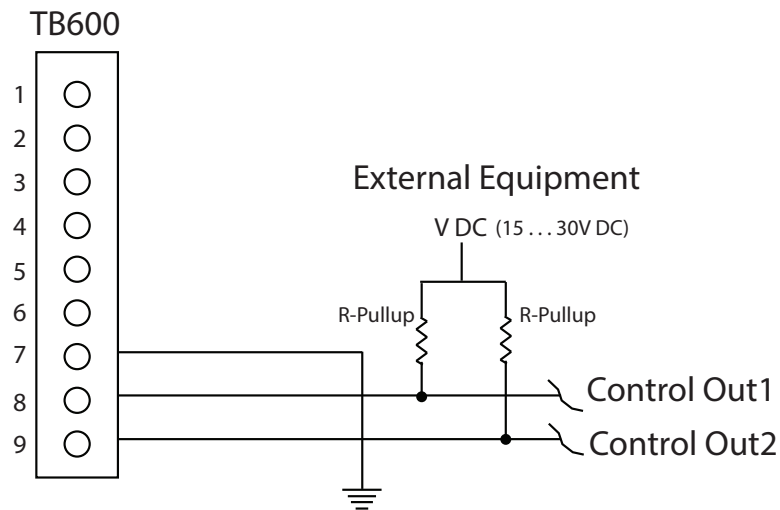

Figure 24: Typical control out 1 & 2 interface with external pullups passive

RS485 Output

The RS485 feature allows up to 126 transmitters to be placed on a single three-wire cable up to 4000 feet. All transmitters are assigned a unique numeric address that allows all of the transmitters on the cable network to be independently accessed. Either Modbus RTU or BACnet MS/TP protocol is used to interrogate the transmitters.

Flow rate and total can be monitored over the digital communications bus.

NOTE: When a USB programming cable is connected, the RS485 and frequency outputs are disabled.

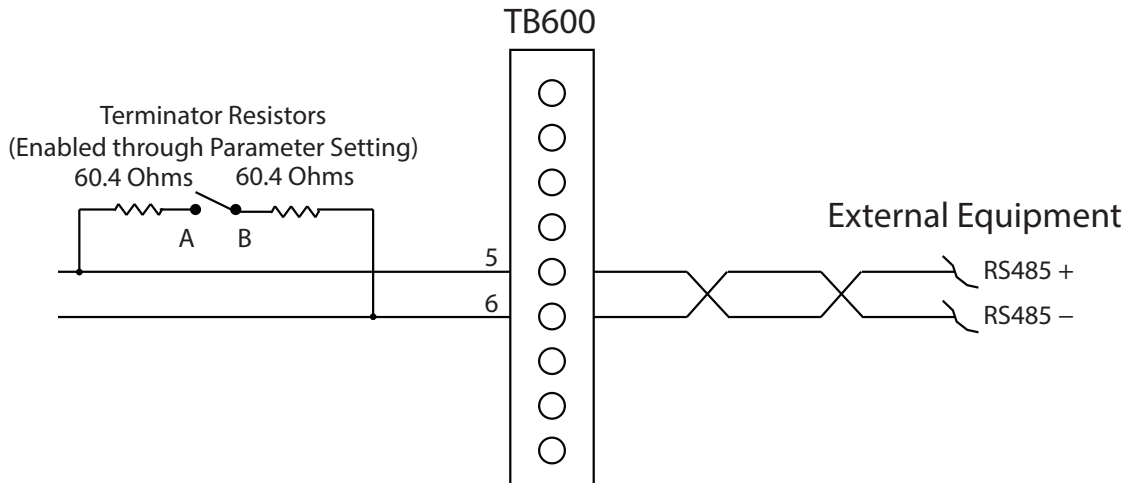

Figure 25: Typical RS485 interface

Digital I/O Wiring

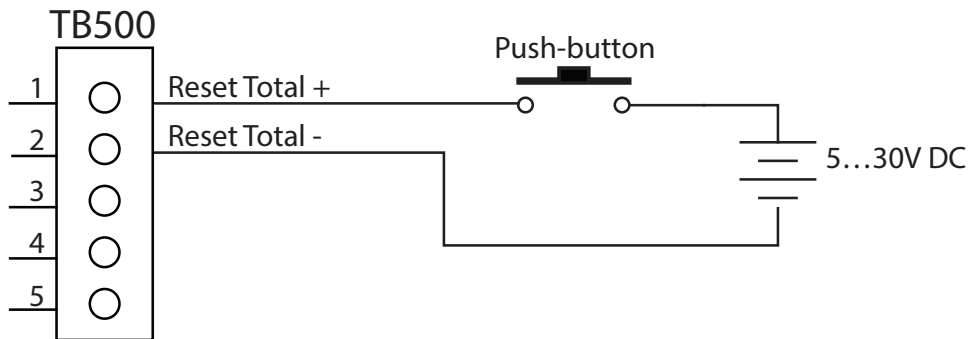

Figure 26: Digital I/O—reset totalizer

AquaCUE/BEACON Endpoint

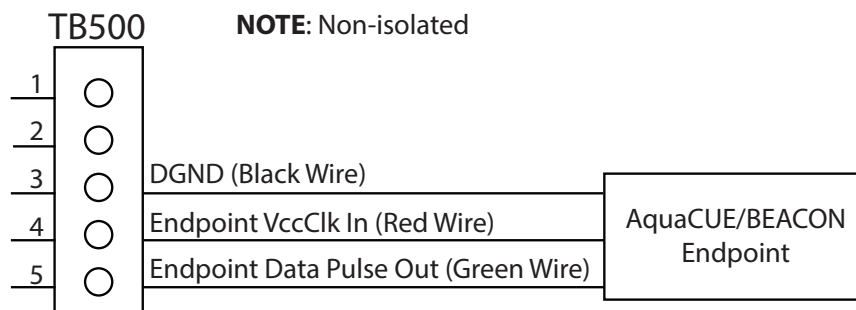

Figure 27: Digital I/O—BMI encoder interface

Initial Meter Setup

You can set up the meter using the TFX-500w keypad or the SoloCUE Flow Device Manager software. This document addresses procedures using the TFX-500w keypad. To use SoloCUE, see the "SoloCUE Flow Device Manager Installation Guide" available at www.badgermeter.com.

When you start the meter for the first time, you must select a language, press **ENTER**, then press **MENU/BACK** to get to **BASIC SETUP**.

In **BASIC SETUP**, program the parameters in the table below using the transmitter's keypad. Enter the pipe characteristics, transducer and mounting in the **SETUP > METER** submenus. For integral mount meters with DTTS/C transducers, these parameters are already set at the factory and you can skip these steps.

For in-depth parameter programming, see "Parameter Descriptions by Menu" on page 20.

Submenu	Parameter	Action
PIPE	PIPE MATERIAL	Select the material of the pipe.
	PIPE TYPE	Select the pipe schedule for ANSI pipes or manual entry of the outside diameter (O.D.) in millimeters or inches. If you select manual entry, you will need to enter the pipe wall thickness. The available options are based on the pipe material selected. If you do not see a valid option, check the pipe material setting.
	PIPE SIZE NOMINAL	When you select an ANSI pipe schedule, you need to select the nominal pipe size in inches. If you do not see a valid option, check the pipe type.
	PIPE SIZE and WALL THICKNESS	When you select MANUAL for Pipe Type, enter the outer diameter and wall thickness of the pipe. The units are based on whether MANUAL INCHES or MANUAL MM was selected for the Pipe Type.
	LINER THICKNESS and LINER MATERIAL (optional)	If there is a liner in the pipe, enter the liner thickness and select the liner material. The units are based on the Pipe Type. If you do not see a valid option, check the Pipe Type.
	I.D. SIZE	The calculated inner diameter based on settings.
TRANSDUCER	DTTN/DTTR 1 MHZ DTTSU 2 MHZ DTTS/DTTC 2 MHZ DTTJ/K EASYRAIL 1 MHZ	If the meter was ordered as a single part number, the transducers are configured at the factory. Otherwise, select the transducer model from the list. The model is marked on one of the transducer heads. If you do not see the transducer model in the list, select a transducer with the same frequency.
MOUNTING OR	Z-PATH V-PATH W-PATH	Select the mounting path to match the required setup. See the transducer user manual to select the best path.
DTTS/DTTC TYPE	DTTS/DTTC TYPE substituted for MOUNTING when TRANSDUCER > DTTS/DTTC is selected.	
SPACING	SPACING CALCULATED	View to see the correct spacing for the transducers.
UNITS	See "Setup > Units" on page 20.	Select the units and format of flow rate, total and velocity.
FLOW SETUP	See "Setup > Meter > Flow Setup" on page 23.	Select flow direction, low flow cutoff, signal cutoffs and filtering.
SET ZERO	Confirmation screen	<ol style="list-style-type: none"> 1. Check that the pipe is full of liquid and not flowing. Flow must be absolutely zero. 2. Securely close any valves and allow time for settling to occur. 3. Select SET ZERO and press OK to set the new zero.

MENU MAP

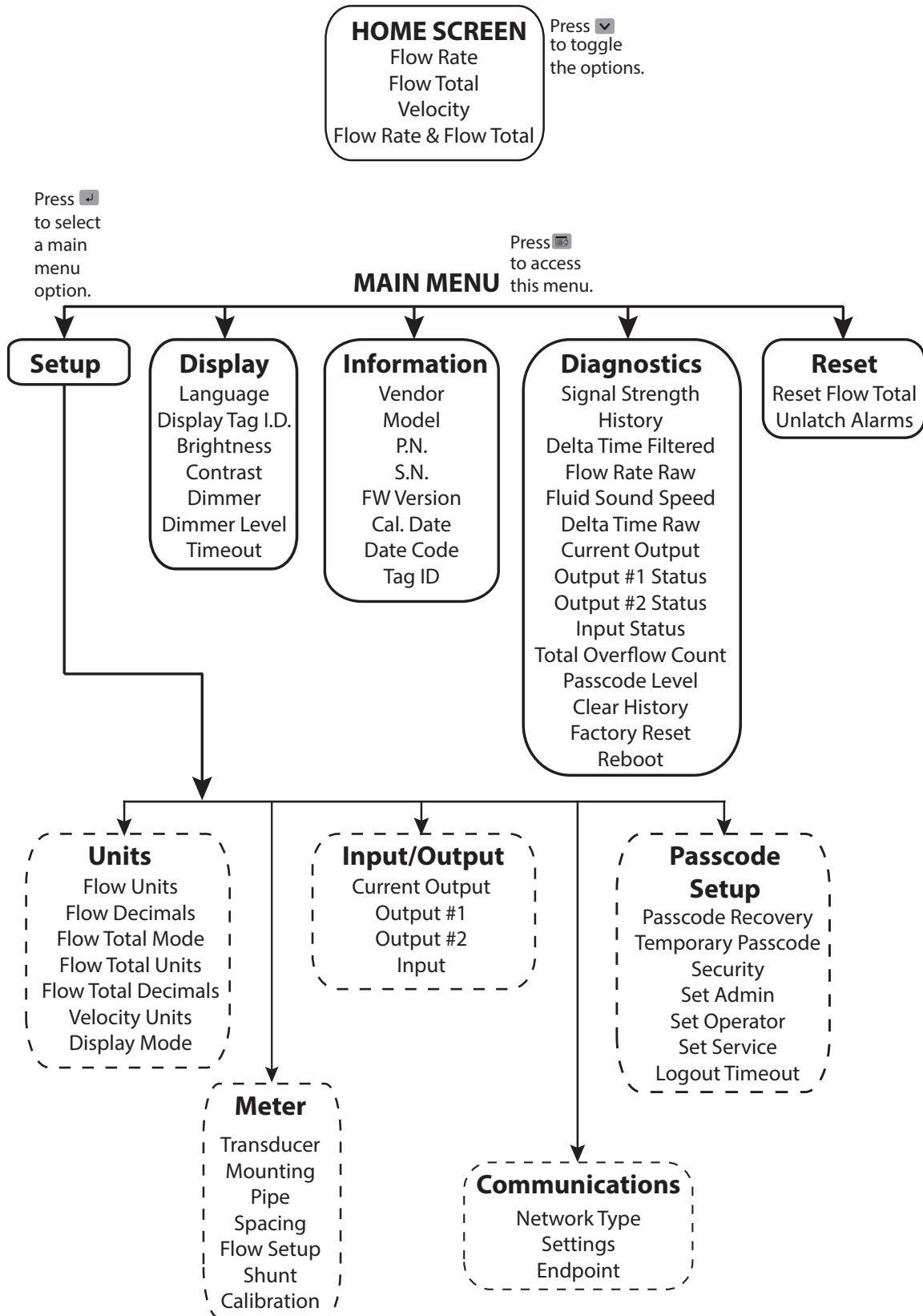

PARAMETER DESCRIPTIONS BY MENU

Main Menu Structure

The transmitter's firmware has a hierarchical menu structure. See "Menu Map" on page 19 for a visual path to the parameters. The five *Main Menus* used in the transmitter firmware are as follows:

Menu	Function
SETUP	Contains all of the configuration parameters for initially programming the transmitter to measure flow
DISPLAY	Configures transmitter display functions
INFORMATION	Displays system information, such as the model number and firmware version
DIAGNOSTICS	Displays system status and allows you to clear the history, reset to factory defaults and reboot the system
RESET	Resets the flow total or unlatches alarms

The following pages define the configuration parameters located in each of the menus.

Setup > Units

Use *SETUP > UNITS* to define the measurement standards for the transmitter.

An asterisk (*) indicates the parameter default.

Units Submenus	Options/Descriptions																																												
FLOW UNITS	Select the flow rate units/interval displayed on the <i>Home Screen</i> . <i>FLOW UNITS</i> are automatically converted into the selected option.																																												
	<table border="1"> <thead> <tr> <th>Option</th> <th>Units/Interval</th> <th>Option</th> <th>Units/Interval</th> </tr> </thead> <tbody> <tr> <td>AC FT/D</td> <td>Acre Feet/Day</td> <td>GAL/S</td> <td>Gallons/Second</td> </tr> <tr> <td>L/S</td> <td>Liters/Second</td> <td>GAL/MIN</td> <td>Gallons/Minute</td> </tr> <tr> <td>L/MIN</td> <td>Liters/Minute</td> <td>GAL/H</td> <td>Gallons/Hour</td> </tr> <tr> <td>L/H</td> <td>Liters/Hour</td> <td>MG/D</td> <td>Million Gallons/Day</td> </tr> <tr> <td>M3/S</td> <td>Cubic Meters/Second</td> <td>IG/S</td> <td>Imperial Gallons/Second</td> </tr> <tr> <td>M3/MIN</td> <td>Cubic Meters/Minute</td> <td>IG/MIN</td> <td>Imperial Gallons/Minute</td> </tr> <tr> <td>M3/H</td> <td>Cubic Meters/Hour</td> <td>IG/H</td> <td>Imperial Gallons/Hour</td> </tr> <tr> <td>FT3/S</td> <td>Cubic Feet/Minute</td> <td>BBL/MIN</td> <td>Barrel/Minute</td> </tr> <tr> <td>FT3/MIN</td> <td>Cubic Feet/Minute</td> <td>MIG/D</td> <td>Million Imperial Gallons/Day</td> </tr> <tr> <td>FT3/H</td> <td>Cubic Feet/Hour</td> <td>BBL/D</td> <td>Barrel/Day</td> </tr> </tbody> </table>	Option	Units/Interval	Option	Units/Interval	AC FT/D	Acre Feet/Day	GAL/S	Gallons/Second	L/S	Liters/Second	GAL/MIN	Gallons/Minute	L/MIN	Liters/Minute	GAL/H	Gallons/Hour	L/H	Liters/Hour	MG/D	Million Gallons/Day	M3/S	Cubic Meters/Second	IG/S	Imperial Gallons/Second	M3/MIN	Cubic Meters/Minute	IG/MIN	Imperial Gallons/Minute	M3/H	Cubic Meters/Hour	IG/H	Imperial Gallons/Hour	FT3/S	Cubic Feet/Minute	BBL/MIN	Barrel/Minute	FT3/MIN	Cubic Feet/Minute	MIG/D	Million Imperial Gallons/Day	FT3/H	Cubic Feet/Hour	BBL/D	Barrel/Day
	Option	Units/Interval	Option	Units/Interval																																									
	AC FT/D	Acre Feet/Day	GAL/S	Gallons/Second																																									
	L/S	Liters/Second	GAL/MIN	Gallons/Minute																																									
	L/MIN	Liters/Minute	GAL/H	Gallons/Hour																																									
	L/H	Liters/Hour	MG/D	Million Gallons/Day																																									
	M3/S	Cubic Meters/Second	IG/S	Imperial Gallons/Second																																									
	M3/MIN	Cubic Meters/Minute	IG/MIN	Imperial Gallons/Minute																																									
	M3/H	Cubic Meters/Hour	IG/H	Imperial Gallons/Hour																																									
	FT3/S	Cubic Feet/Minute	BBL/MIN	Barrel/Minute																																									
	FT3/MIN	Cubic Feet/Minute	MIG/D	Million Imperial Gallons/Day																																									
	FT3/H	Cubic Feet/Hour	BBL/D	Barrel/Day																																									
FLOW DECIMALS	This is a numeric entry for the number of decimal places to display. Default is 2. Options are 0...7																																												
FLOW TOTAL MODE	*GROSS FLOW Any flow in forward and reverse direction. FORWARD FLOW REVERSE FLOW NET FLOW Forward flow minus reverse flow. A negative total results when reverse flow is greater than forward flow..																																												
FLOW TOTAL UNITS	Select the units for the flow total displayed on the <i>Home Screen</i> . <i>FLOW TOTAL UNITS</i> are automatically converted into the selected option:																																												
	<table border="1"> <thead> <tr> <th>Option</th> <th>Units</th> <th>Option</th> <th>Units</th> </tr> </thead> <tbody> <tr> <td>GAL</td> <td>Gallons</td> <td>MIGAL</td> <td>Million Gallons</td> </tr> <tr> <td>MGAL</td> <td>Million Gallons</td> <td>L</td> <td>Liter</td> </tr> <tr> <td>IGAL</td> <td>Imperial Gallons</td> <td>HL</td> <td>Hectoliter</td> </tr> <tr> <td>AC-FT</td> <td>Acre Feet</td> <td>M3</td> <td>Cubic Meters</td> </tr> <tr> <td>BBL</td> <td>Barrel</td> <td>FT3</td> <td>Cubic Feet</td> </tr> </tbody> </table>	Option	Units	Option	Units	GAL	Gallons	MIGAL	Million Gallons	MGAL	Million Gallons	L	Liter	IGAL	Imperial Gallons	HL	Hectoliter	AC-FT	Acre Feet	M3	Cubic Meters	BBL	Barrel	FT3	Cubic Feet																				
	Option	Units	Option	Units																																									
	GAL	Gallons	MIGAL	Million Gallons																																									
	MGAL	Million Gallons	L	Liter																																									
	IGAL	Imperial Gallons	HL	Hectoliter																																									
AC-FT	Acre Feet	M3	Cubic Meters																																										
BBL	Barrel	FT3	Cubic Feet																																										
FLOW TOTAL DECIMALS	This is a numeric entry for the number of decimal places to display. Default is 0. Options are 0...7.																																												
VELOCITY UNITS	Select the units for the velocity displayed on the <i>Home Screen</i> . *FT/S Feet/Second M/S Meters/Second																																												

Units Submenus	Options/Descriptions
DISPLAY MODE	Select whether to display the flow rate, flow total, velocity or both flow rate and flow total on the display. Alternatively, you can change the display from the <i>Home Screen</i> by pressing the <i>DOWN</i> button. *FLOW RATE FLOW TOTAL VELOCITY FLOW/TOTAL

Setup > Meter

An asterisk (*) indicates the parameter default.

Meter Submenus	Options/Descriptions	
TRANSDUCER	Select the transducer type:	
	DTTSU 2 MHZ	Option UZ when ordered with the TFX-500w meter
	DTTS/DTTC 2 MHZ	Options CA...CS and CZ when ordered with the TFX-500w meter
	DTTJ/K EASYRAIL 1 MHZ	Options JZ and KZ when ordered with the TFX-500w meter
	DTTN/DTTR 1 MHZ	Options NZ, WZ and RZ when ordered with the TFX-500w meter
MOUNTING	For mounting options, see the transducer user manual. Z PATH *V PATH W PATH	
DTTS/DTTC TYPE	DTTS/DTTC TYPE is substituted for MOUNTING when TRANSDUCER DTTS/DTTC is selected as the transducer type. CA: 1/2 IN ANSI CJ: 1-1/4 IN COPPER CB: 3/4 IN ANSI CK: 1-1/2 IN COPPER CC: 1 IN ANSI CL: 2 IN COPPER CD: 1-1/4 IN ANSI CM: 1/2 IN SS TUBE CE: 1-1/2 IN ANSI CN: 3/4 IN SS TUBE CF: 2 IN ANSI CP: 1 IN SS TUBE CG: 1/2 IN COPPER CQ: 1-1/4 IN SS TUBE CH: 3/4 IN COPPER CR: 1-1/2 IN SS TUBE CT: 1 IN COPPER CS: 2 SS IN TUBE	

Setup > Meter > Pipe

An asterisk (*) indicates the parameter default.

Pipe Submenus	Options/Descriptions																																									
PIPE MATERIAL	*STAINLESS 316 CARBON STEEL PFA TEFLON STAINLESS 347 COPPER PVC CPVC STAINLESS 410 IRON - CAST STAINLESS 302/303 STAINLESS 430 IRON - DUCTILE STAINLESS 304 ALUMINUM HD POLYETHYLENE STAINLESS 304L BRASS NAVAL LD POLYETHYLENE PVDF																																									
PIPE TYPE	<p>For the best accuracy, measure the outer diameter and wall thickness with a gauge and select MANUAL INCHES or MANUAL MM.</p> <p>If you do not have a gauge, you can select an ASME/ANSI or ASTM definition.</p> <p>If stainless steel pipe, carbon steel, PVC, CPVC material is selected, the following pipe schedules are also available:</p> <table border="0"> <tr> <td>SCHEDULE STD</td> <td>SCHEDULE 80</td> <td>CLASS A CLASS 50</td> </tr> <tr> <td>SCHEDULE 5</td> <td>SCHEDULE 100</td> <td>CLASS B CLASS 51</td> </tr> <tr> <td>SCHEDULE 10</td> <td>SCHEDULE 120</td> <td></td> </tr> <tr> <td>SCHEDULE 20</td> <td>SCHEDULE 140</td> <td></td> </tr> <tr> <td>SCHEDULE 30</td> <td>SCHEDULE 160</td> <td></td> </tr> <tr> <td>SCHEDULE 40</td> <td>SCHEDULE 180</td> <td></td> </tr> <tr> <td>SCHEDULE 60</td> <td>SCHEDULE STG</td> <td></td> </tr> </table> <p>If copper material is selected, the following types are also available.</p> <table border="0"> <tr> <td>TYPE K</td> <td>TYPE L</td> <td>TYPE M</td> <td>PIPE SIZE</td> </tr> </table> <p>If cast iron pipe material is selected, the following classes are also available:</p> <table border="0"> <tr> <td>CLASS A</td> <td>CLASS E</td> </tr> <tr> <td>CLASS B</td> <td>CLASS F</td> </tr> <tr> <td>CLASS C</td> <td>CLASS G</td> </tr> <tr> <td>CLASS D</td> <td>CLASS H</td> </tr> </table> <p>If ductile iron pipe material is selected, the following classes are also available:</p> <table border="0"> <tr> <td>CLASS 50</td> <td>CLASS 54</td> </tr> <tr> <td>CLASS 51</td> <td>CLASS 55</td> </tr> <tr> <td>CLASS 52</td> <td>CLASS 56</td> </tr> <tr> <td>CLASS 53</td> <td></td> </tr> </table> <p>If aluminum or brass naval material, enter the pipe size in inches.</p>	SCHEDULE STD	SCHEDULE 80	CLASS A CLASS 50	SCHEDULE 5	SCHEDULE 100	CLASS B CLASS 51	SCHEDULE 10	SCHEDULE 120		SCHEDULE 20	SCHEDULE 140		SCHEDULE 30	SCHEDULE 160		SCHEDULE 40	SCHEDULE 180		SCHEDULE 60	SCHEDULE STG		TYPE K	TYPE L	TYPE M	PIPE SIZE	CLASS A	CLASS E	CLASS B	CLASS F	CLASS C	CLASS G	CLASS D	CLASS H	CLASS 50	CLASS 54	CLASS 51	CLASS 55	CLASS 52	CLASS 56	CLASS 53	
SCHEDULE STD	SCHEDULE 80	CLASS A CLASS 50																																								
SCHEDULE 5	SCHEDULE 100	CLASS B CLASS 51																																								
SCHEDULE 10	SCHEDULE 120																																									
SCHEDULE 20	SCHEDULE 140																																									
SCHEDULE 30	SCHEDULE 160																																									
SCHEDULE 40	SCHEDULE 180																																									
SCHEDULE 60	SCHEDULE STG																																									
TYPE K	TYPE L	TYPE M	PIPE SIZE																																							
CLASS A	CLASS E																																									
CLASS B	CLASS F																																									
CLASS C	CLASS G																																									
CLASS D	CLASS H																																									
CLASS 50	CLASS 54																																									
CLASS 51	CLASS 55																																									
CLASS 52	CLASS 56																																									
CLASS 53																																										
PIPE SIZE	Available only when PIPE TYPE is MANUAL. Numeric entry; min. 0.5 in. (15 mm), max. 10 in. (250 mm)																																									
PIPE SIZE NOMINAL	PIPE SIZE NOMINAL is substituted for PIPE SIZE when a schedule/tubing/class is selected. Enumeration based on schedule; Min 1/2 inch, Max 10 inch 1/2, 3/4, 1, 1-1/4, *1-1/2, 2, 2-1/2, 3, 3-1/2, 4, 5, 6, 8, 10																																									
WALL THICKNESS	Numeric entry; *min. 0.00, max. 5 in. (125 mm); TFX-500w limited to 1 in. WALL THICKNESS is only useful for MANUAL METRIC and MANUAL INCHES and DTTS tubing pipe types. It can be skipped for pipe schedule, tubing and classes.																																									
LINER MATERIAL	<table border="0"> <tr> <td>NONE</td> <td>HD POLYETHYLENE</td> <td>TAR EPOXY</td> </tr> <tr> <td>ACRYLIC</td> <td>LD POLYETHYLENE</td> <td>PFE TEFLON</td> </tr> <tr> <td>ASBESTOS CEMENT</td> <td>POLYPROPYLENE</td> <td>GLASS PYREX</td> </tr> <tr> <td>EBONITE</td> <td>POLYSTYRENE</td> <td>FIBERGLASS EPOXY</td> </tr> <tr> <td>MORTAR</td> <td>RUBBER</td> <td></td> </tr> </table>	NONE	HD POLYETHYLENE	TAR EPOXY	ACRYLIC	LD POLYETHYLENE	PFE TEFLON	ASBESTOS CEMENT	POLYPROPYLENE	GLASS PYREX	EBONITE	POLYSTYRENE	FIBERGLASS EPOXY	MORTAR	RUBBER																											
NONE	HD POLYETHYLENE	TAR EPOXY																																								
ACRYLIC	LD POLYETHYLENE	PFE TEFLON																																								
ASBESTOS CEMENT	POLYPROPYLENE	GLASS PYREX																																								
EBONITE	POLYSTYRENE	FIBERGLASS EPOXY																																								
MORTAR	RUBBER																																									
LINER THICKNESS	Numeric entry; min. 0.00, max. 20 in. (500 mm)																																									
I.D. SIZE	Numeric display *1.682 in.																																									

Setup > Meter > Spacing

This menu is available only for adjustable spacing transducers, not fixed spacing. An asterisk (*) indicates the default.

Spacing Submenu	Options/Descriptions
MODE	*SPACING CALCULATED
CALCULATED	The spacing required between two transducers based on the pipe parameters. Take this measurement between the lines scribed into the side of the transducers or use the scale on the rails, if used. See the transducer user manual. Numeric display 0...300 units in. or mm based on PIPE SIZE selection. *0.954 in.

Setup > Meter > Flow Setup

An asterisk (*) indicates the parameter default.

Flow Setup Submenus	Options/Descriptions
DIRECTION	*FORWARD REVERSE
BIDIRECTIONAL	*ENABLED DISABLED
LOW FLOW CUTOFF	Numeric entry. Units and decimals are based on FLOW RATE UNITS. Zero and positive values. *0.0
SIGNAL CUTOFF	*30%
SIGNAL HIGH	*90%
MINIMUM FLOW	-100,000
MAXIMUM FLOW	100,000
DAMPING	*40 seconds
SENSITIVITY	*60%
HYSTERESIS	*5%
BAD DATA REJECTION	*3
FILTER METHOD	*Adaptive
WAVE	<ul style="list-style-type: none"> *AUTO automatically selects waveform based on flow speed and signal quality. SIN CARROT TOP is best for low speed flow. BEST BARKER is best for high speed flow.

For detailed information on these parameters, see "Filter Parameters" following this table.

Filter Parameters

Filter Method (Default: Adaptive)

The TFX-500w flow meter offers three levels of signal filtering:

- *None* imposes no filtering on the signal from the transducers.
- *Simple with Rejection* uses *Damping* and *Bad Data Rejection* to filter the flow data.
- **Adaptive* filtering allows the meter's software routines to alter the filtering, depending on the variability of the transducer's signal. The *Adaptive* filter uses a combination of *Damping*, *Bad Data Rejection*, *Sensitivity* and *Hysteresis* to modify the flow input data.

Damping (Range 0...100 Seconds; Default: 40 Seconds)

Damping is the approximate amount of time the filtering routines use to attain a 99% stable rate value. Generally, the higher the damping value, the more stable the rate readings are—but at the expense of response time.

Sensitivity (Range 0...100%; Default: 60%)

Sensitivity determines how fast the adaptive filtering responds to a change in rate. Increasing the sensitivity decreases the filtering, which allows the display to respond to rate changes more rapidly.

Hysteresis (Range 0...25%; Default: 5%)

Hysteresis creates a window around the average flow measurement reading, defining the limits at which the automatic damping increases occur. If the rate varies within the hysteresis window, greater damping occurs up to the maximum values set by the flow filter *Damping* entry. The filter also establishes a flow rate window where measurements outside of the window are captured by the *Bad Data Rejection* window. Enter the value as a percentage of actual flow rate.

For instance, a *Hysteresis* setting of 5% allows the flow to vary $\pm 5\%$ from the currently established flow rate without automatically decreasing the value of the *Damping*.

For example, if the average flow rate is 100 gpm and the *Hysteresis* is set to 10%, a filter window of 90...110 gpm is established. Successive flow measurements that reside within that window are recorded and averaged in accordance with the *Damping* setting. Flow readings outside of the window are rejected or accepted in accordance with the *Bad Data Rejection* setting.

Filter settings for this example:

Filter Method	Adaptive
Damping	40 seconds
Sensitivity	60%
Hysteresis	10%
Bad Data Rejection	3

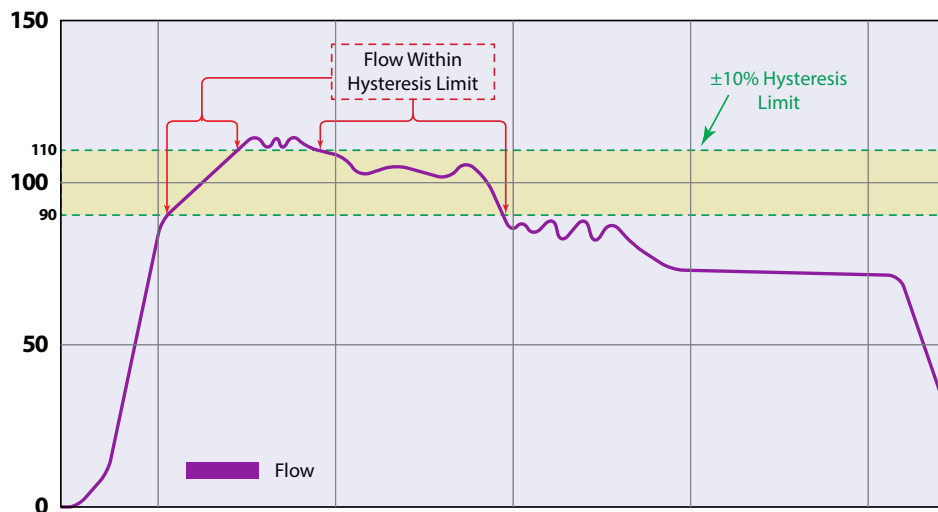

Figure 28: Hysteresis window

Bad Data Rejection (Range 0...10 Samples; Default: 3)

The *Bad Data Rejection* setting is related to the number of successive *readings* that must be measured outside of a the *Hysteresis* value before the flow meter considers the new flow value valid. In this example, a *Hysteresis* setting of 10% produces a $\pm 10\%$ band centered on the current valid flow rate of 100 gpm.

The *Bad Data Rejection* setting is the number of successive *samples* that must be outside of the *Hysteresis* window before the flow meter considers the change in flow as real. Larger values are entered into the *Bad Data Rejection* window when measuring liquids that contain gas bubbles, as the gas bubbles tend to disturb the ultrasonic signals and cause more extraneous flow readings to occur. Larger *Bad Data Rejection* values tend to make the flow meter less responsive to rapid changes in actual flow rate.

In *Figure 30 on page 25*, flow data falls outside the flow *Hysteresis* window but does not reach the minimum time specified in the *Bad Data Rejection* window. When data appears that is outside the *Hysteresis* band and shorter than the *Bad Data Rejection* window time, the data is rejected.

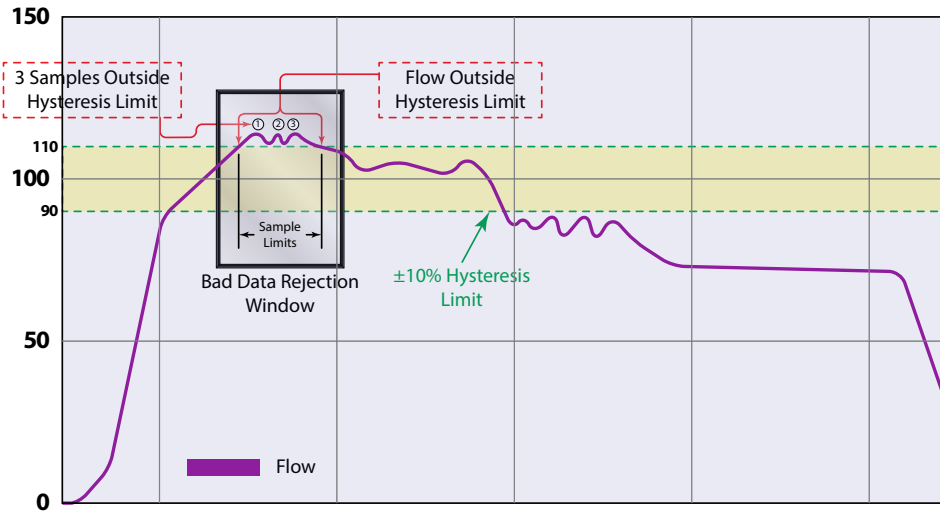

Figure 29: Bad data (rejection)

The flow rate is again outside the original $\pm 10\%$ Hysteresis window, but the data exists for a time period greater than the *Bad Data Rejection* window. In this instance, the meter interprets the data as a new valid flow rate and moves the *Hysteresis* window to correspond with the new established flow rate.

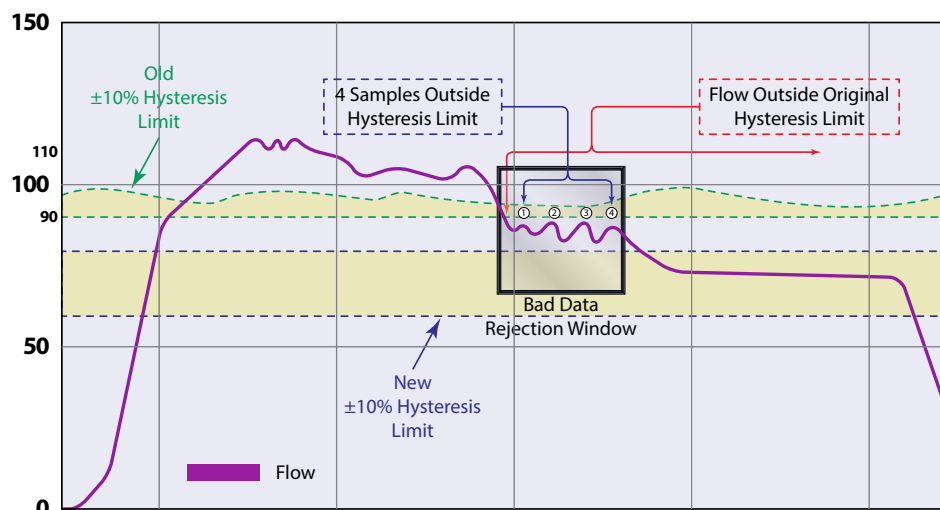

Figure 30: New valid flow data

Setup > Meter > Shunt

An asterisk (*) indicates the parameter default.

Shunt Submenu	Options/Descriptions
SHUNT	<p>Changing the <i>SHUNT</i> attenuates the received wave. If the signal strength is too low or too oversaturated (too high), adjust the <i>SHUNT</i> setting. The 10 Ohm setting attenuates the most.</p> <ul style="list-style-type: none"> • 10 Ohm, minimize signal • 26.1 Ohm, mid-range signal • *NONE, maximize signal

Setup > Meter > Calibration

An asterisk (*) indicates the parameter default.

Calibration Submenus	Options/Descriptions	
<i>FACTOR MODE</i>	*FACTORY FIELD	Selects whether to use <i>FACTORY</i> calibration or to substitute a <i>FIELD</i> value entered after a meter is installed.
<i>FACTORY SETTINGS</i>	ZERO	The zero offset entered during factory calibration. <i>ZERO</i> is for reference only and most likely the <i>ZERO VALUE</i> for your installation will be different from the factory <i>ZERO</i> . Numeric display *0.000 ns.
	CAL FACTOR	Numeric display #.*1.000 ns.
<i>SET ZERO</i>	SET ZERO confirmation screen. Select OK or CANCEL.	
<i>ZERO VALUE</i>	Numeric display ##.### ns	
<i>SCALE FACTOR</i>	Numeric entry. Default is 1.00	The factor used for linearizing the flow rate calculation when <i>FIELD</i> is selected for <i>FACTOR MODE</i> .

Set Zero Procedure

SET ZERO removes the No Flow transit time offset. This is also referred to as Zeroing the meter.

Because every flow meter installation is slightly different and sound waves can travel in slightly different ways through these various installations, it is important to remove the zero offset at zero flow to maintain the meter's accuracy. To establish Zero flow and eliminate the offset:

1. The pipe must be full of liquid.
2. Flow must be absolutely zero. Securely close any valves and allow time for any settling to occur.
3. Press **SET ZERO** once.

Factor Mode Procedure

The TFX-500w flow meter can be shipped as a transmitter and transducer set or the transmitter and transducers can be shipped separate items. When it ships as a flow meter set, the meter is calibrated at the factory with *CAL FACTOR* (calibration factor) set for the transducers. When the transmitter and transducers ship as separate items, the transducer calibration factor printed on the transducer label must be entered into the transmitter as the *SCALE FACTOR*.

To enter the *SCALE FACTOR*:

1. Change the *FACTOR MODE* from *FACTORY* to *FIELD*.
2. For *SCALE FACTOR*, enter the calibration factor.

Field Calibration Procedure

To calibrate the TFX-500w flow meter, use a master meter or gravimetric test stand.

1. Set *FACTOR MODE* to **FIELD**.
2. Verify *SCALE FACTOR* is set to **1**.
3. Run calibration test.
4. Calculate the *SCALE FACTOR*.

$$\text{SCALE FACTOR} = (\text{actual flow})/(\text{meter flow rate}) \text{ or } (\text{actual total})/(\text{meter total})$$
5. Enter the *SCALE FACTOR*.

Setup > Input/Output > Current Output

The current output, reset input and frequency/pulse/status output can be set up through the *SETUP > INPUT/OUTPUT* menus. An asterisk (*) indicates the parameter default.

Current Output Submenus	Options/Descriptions		
<i>OUTPUT SOURCE</i>	<table border="1"> <tr> <td>*FLOW RATE VELOCITY SIGNAL STRENGTH TEST MODE DISABLED</td> <td>Select the reading to be assigned to the 4...20 mA output.</td> </tr> </table>	*FLOW RATE VELOCITY SIGNAL STRENGTH TEST MODE DISABLED	Select the reading to be assigned to the 4...20 mA output.
*FLOW RATE VELOCITY SIGNAL STRENGTH TEST MODE DISABLED	Select the reading to be assigned to the 4...20 mA output.		
<i>RANGE</i>	*4-20 mA 0-20 mA		
<i>MIN VALUE</i>	Enter the value of the reading at 4 mA. Can also be the setting for the 0 mA setpoint when 4-20 mA <i>RANGE</i> is selected. Units and decimal places based on parameter selected. Negative numbers accepted.		
<i>MAX VALUE</i>	Enter the value of the reading at 20 mA. Units and decimal places based on parameter selected. Negative numbers accepted.		
<i>TEST CURRENT</i>	Available only when <i>OUTPUT SOURCE</i> is in <i>TEST MODE</i> . Default 12.00 mA. To check the wiring to the control system or gauge, you can override the current output with a fixed current. Numeric entry mA. 0...22 mA.		
<i>TRIM 4 mA</i>	Available only when <i>OUTPUT SOURCE</i> is in <i>TEST MODE</i> . Set the test current to 4 mA. Adjusts output until PLC/DCS/BAS reads 4 mA.		
<i>TRIM 20 mA</i>	Available only when <i>OUTPUT SOURCE</i> is in <i>TEST MODE</i> . Set the test current to 20 mA. Adjusts output until PLC/DCS/BAS reads 20 mA.		

Setup > Inputs/Output > Output #1 (or Output #2)

Output #1 and output #2 can operate independently as a frequency, totalizer pulse, direction status or alarm status output. In the *SETUP > INPUT/OUTPUTS > OUTPUT #1 (OR OUTPUT #2) > MODE* menu, select the *MODE* of operation. Then go to the *PARAMETERS* menu to set up the operation for that *MODE*.

An asterisk (*) indicates the parameter default.

Output #1 Submenus	Options/Descriptions																						
MODE	*FREQUENCY PULSE TOTAL FLOW DIRECTION ALARM DISABLED																						
PARAMETERS (Frequency Mode)	OUTPUT SOURCE	*FLOW RATE VELOCITY TEST MODE	Select the reading to assign to the frequency output.																				
	VALUE AT 0 HZ	Numeric entry. Units based on parameter selected. Negative numbers accepted. Default -5000.	Enter the maximum flow rate or velocity frequency that corresponds to maximum frequency flow rate or velocity. Can be negative to indicate reverse flow. The units of <i>Maximum</i> match the units in <i>SETUP > MEASUREMENTS > FLOW UNITS</i> .																				
	MAX VALUE	Numeric entry. Units based on source selected. Negative numbers accepted. Default 5000.	Example 1:																				
	MAX FREQUENCY	Numeric entry. Units in Hz. Default 1 kHz.	For a system that only has flow in one direction, the maximum flow rate is 100 gal/min, and the corresponding maximum frequency is 2000 Hz, set up the parameters to: <table border="1" data-bbox="846 905 1284 1052"> <thead> <tr> <th>Parameter</th> <th>Value</th> </tr> </thead> <tbody> <tr> <td>Output Source</td> <td>Flow Rate</td> </tr> <tr> <td>Minimum</td> <td>0 gal/min</td> </tr> <tr> <td>Maximum</td> <td>100 gal/min</td> </tr> <tr> <td>Maximum Frequency</td> <td>2000 Hz</td> </tr> </tbody> </table> Example 2: For a system that flow is bidirectional, the flow rate ranges from -100 gal/min to 100 gal/min and the frequency at 100 gal/min is 2000 Hz, set up the parameters to: <table border="1" data-bbox="846 1192 1289 1339"> <thead> <tr> <th>Parameter</th> <th>Value</th> </tr> </thead> <tbody> <tr> <td>Output Source</td> <td>Flow Rate</td> </tr> <tr> <td>Minimum</td> <td>-100 gal/min</td> </tr> <tr> <td>Maximum</td> <td>100 gal/min</td> </tr> <tr> <td>Maximum Frequency</td> <td>2000 Hz</td> </tr> </tbody> </table> With this setup at <i>no flow</i> , the frequency output is 1000 Hz..	Parameter	Value	Output Source	Flow Rate	Minimum	0 gal/min	Maximum	100 gal/min	Maximum Frequency	2000 Hz	Parameter	Value	Output Source	Flow Rate	Minimum	-100 gal/min	Maximum	100 gal/min	Maximum Frequency	2000 Hz
	Parameter	Value																					
Output Source	Flow Rate																						
Minimum	0 gal/min																						
Maximum	100 gal/min																						
Maximum Frequency	2000 Hz																						
Parameter	Value																						
Output Source	Flow Rate																						
Minimum	-100 gal/min																						
Maximum	100 gal/min																						
Maximum Frequency	2000 Hz																						
TEST FREQUENCY	Available when <i>TEST MODE</i> is selected for <i>OUTPUT SOURCE</i> . To check the wiring to the control system or device, you can override the frequency output with a fixed frequency.																						
OUTPUT SOURCE	*POSITIVE FLOW NEGATIVE FLOW BIDIRECTIONAL	Select whether the pulse output accumulates only on positive (forward) flow, only on negative (reverse) flow or anytime flow occurs regardless of the flow direction (bidirectional). For bidirectional, assign the direction status to the other output, if desired.																					
SCALING FACTOR	Numeric entry. Units based on flow rate selection. Default 1 units per pulse. Enter the number of pulses per totalizer unit. The totalizer unit is in the <i>SETUP > MEASUREMENTS</i> menu. For example, if the totalizer unit is gallons, setting the <i>PULSES/UNIT</i> to 1 transmits 1 pulse every gallon. Setting the <i>SCALING FACTOR</i> to 0.1 transmits 1 pulse every 0.1 gallons.																						
PULSE WIDTH	Numeric entry 5...2000 ms. Default 50 ms. Enter the pulse width in milliseconds.																						
PULSE STATE	*PULSE LOW PULSE HIGH	<i>PULSE LOW</i> , the pulse totalizer output remains in the off state and the voltage floats at the source voltage level. When the pulse is triggered, the output turns on and the voltage drops to the low voltage level. This setup uses the least power. If the pulse needs to be at the high voltage level, use the <i>PULSE HIGH</i> option.																					

Output #1 Submenus	Options/Descriptions		
PARAMETERS (Flow Direction Mode)	OUTPUT SOURCE	*FLOW RATE	
	DIRECTION	FORWARD ON *REVERSE ON Select whether the output is active when the flow is forward or reverse. When the absolute value of the flow rate is below the cutoff, the output will not be active.	
PARAMETERS (Alarm Mode)	ALARM	HIGH FLOW LOW FLOW OUT OF RANGE *ERRORS ONLY ALL Select the flow condition or meter condition to trigger the alarm and turn on the output.	
	SET HIGH	Numeric entry. Units and decimal place based on FLOW RATE selected. Negative numbers accepted. Default is 1. Enter the value that the flow rate must be greater than in order to trigger an alarm. <i>SET HIGH</i> is only visible/settable when <i>ALARM</i> is set to <i>HIGH FLOW</i> , <i>OUT OF RANGE</i> or <i>ALL</i> .	
	SET LOW	Numeric entry. Units and decimal place based on FLOW RATE selected. Negative numbers accepted. Default is 0. Enter the value that the flow rate must be less than in order to trigger an alarm. <i>SET LOW</i> is only visible/settable when <i>ALARM</i> is set to <i>LOW FLOW</i> , <i>OUT OF RANGE</i> or <i>ALL</i> .	
	LATCHING	*DISABLED ENABLED When <i>ENABLED</i> , the output remains on after the alarm condition clears. Resetting alarm latch turns off the output.	
	ANTI-CHATTER	SET DELAY	Enter how long the alarm condition must occur before activating the output to prevent nuisance trips. Numeric entry. Default is 100 ms.
		RELEASE DELAY	Enter how long the alarm condition is cleared before resetting the output to prevent the output from chattering. The parameter is only valid if <i>LATCHING</i> is <i>DISABLED</i> . Numeric entry. Default is 100 ms.
	MIN ON-TIME	Numeric entry. Default is 200 ms.	
PULL UP RESISTOR	INTERNAL *EXTERNAL	See "Digital I/O Wiring" on page 17.	

Setup > Inputs/Output > Input

An asterisk (*) indicates the parameter default.

Input Submenus	Options/Descriptions	
MODE	DISABLED	Select the action to take when the input is active (based on the state).
	*RESET FLOW TOTAL	
	UNLATCH ALARM	
STATE	*ACTIVE ON HIGH	Select the voltage level to make the input active.
	ACTIVE ON LOW	

Setup > Communications

For addressing information, see the "TFX-500w Clamp-On Meter Modbus RTU Protocol" user manual or the "TFX-500w Clamp-On Meter BACnet MS/TP Protocol" user manual, available at www.badgermeter.com.

An asterisk (*) indicates the parameter default.

Communication Submenus	Options/Descriptions		
NETWORK TYPE	DISABLE		
	*MODBUS RTU	Either disable this feature or select a network type.	
	BACNET MS/TP		
SETTINGS	MODBUS RTU	ADDRESS	Numeric entry 1...127
		BAUD RATE	9600, 19200, 38400, 57600, 76800, 115200
		ACCESS	WRITE/READ allows full access. RESET/READ allows you to read any, but only write to Flow Total Reset (cannot set up meter). READ ONLY allows read only.
		PARITY	*NONE ODD PARITY EVEN PARITY
		STOP BIT	*1 STOP BIT 2 STOP BITS
		RESISTOR	*DISABLED ENABLED
		WORD ORDER	BIG ENDIAN *LITTLE ENDIAN
		TIMEOUT	*DISABLE Numeric entry 0...10000 ms
	BACNET MS/TP	MAC ADDRESS	Numeric entry 0...254
		BACNET ID	Numeric entry 0...4194303
		BAUD RATE	9600, 19200, 38400, 57600, 76800, 115200
		ACCESS	WRITE/READ READ ONLY PASSCODE
		MAX MASTER	Numeric entry 1...127
		PARITY	*NONE ODD PARITY EVEN PARITY
STOP BIT		*1 STOP BIT 2 STOP BITS	
RESISTOR	DISABLED *ENABLED		
ENDPOINT	DIAL COUNT	7, *8, 9, 10	
	RESOLUTION	*OFF, 1, 10, 100, 1000, 10000, 0.1, 0.01, 0.001, 0.0001	
	PROTOCOL	*DISABLED V1 V2 V3	

Setup > Passcode Setup

If *SECURITY* is enabled and you exit the *MAIN MENU*, you must re-enter your passcode to access the *MAIN MENU* again.

Passcode Setup offers three levels of access:

- ADMIN— Default *ADMIN* passcode 000000 must be entered to change security from *DISABLE* to *ENABLE*
- OPERATOR
- SERVICE

Passcode Setup Submenus	Options/Descriptions	
<i>SET ADMIN</i>	6-digit passcode	Numeric entry.
<i>SET OPERATION</i>	6-digit passcode	Numeric entry.
<i>SET SERVICE</i>	6-digit passcode	Numeric entry.
<i>LOGOUT TIMEOUT</i>	1 MINUTE 5 MINUTES *10 MINUTES 20 MINUTES 30 MINUTES 60 MINUTES	When logout occurs, the display returns to the <i>Home Screen</i> .

Only the *ADMIN* level can reset passcodes. If the *ADMIN* passcode is lost and the passcodes need to be reset, you can contact Badger Meter, provide a recovery code to the representative and request a temporary passcode.

To generate a recovery code:

1. Select **PASSCODE RECOVERY**.
2. The next screen prompts you to generate a recovery code or cancel the request. When you request the code, it displays on the screen. Write the number in a safe place.
3. Press **MENU/BACK** and continue to operate the meter in read-only mode.

You will not be prompted to enter a passcode when you navigate the menus. You have the option of canceling the recovery process and continue to use the existing passcodes by entering the *ADMIN* passcode. The *PASSCODE LEVEL* in the *DIAGNOSTIC* menu will be set to *RECOVERY* until you successfully enter a new *ADMIN* passcode or cancel the recovery.

When you receive your temporary passcode, select **SETUP > PASSCODE SETUP > TEMPORARY PASSCODE** and enter your temporary passcode. You will automatically be prompted to enter a new *ADMIN* passcode (prompt will be either in the SoloCUE® software utility or the front panel, depending on where the temporary passcode was entered). If you do not enter a new *ADMIN* passcode within 15 minutes, the recovery mode is canceled and you must request a new recovery code to reset the passcodes. *TEMPORARY PASSCODE* can be entered from the SoloCUE software utility or the front panel, regardless of what was used to start it.

An asterisk (*) indicates the parameter default.

Passcode Setup Submenus	Options/Descriptions	
<i>PASSCODE RECOVERY</i>	Passcode recovery screen	
<i>TEMPORARY PASSCODE</i>	Numeric entry	After 20 attempts to enter the temporary passcode, you will be prompted to generate a new <i>RECOVERY CODE</i> .
<i>SECURITY</i>	*DISABLED ENABLED	When <i>SECURITY</i> is enabled, you are prompted to set the service and operator passwords. If you do not, the defaults remain in place.

Display Menu

An asterisk (*) indicates the parameter default.

Display Submenus	Options/Descriptions	
LANGUAGE	*ENGLISH	English
	DEUTSCHE	German
	ESPAÑOL (#.#)	Spanish. The language selection determines if the decimal indicator is a period or a comma.
	ESPAÑOL (#,#)	
	FRANÇAIS	French
DISPLAY TAG ID	*DISABLED ENABLED	Display the TAG ID on the Home Screen. Default is TFX-500w. Use SoloCUE Flow Device Manager to change the TAG ID.
BRIGHTNESS	Select the display brightness 10...100% in increments of 10. Default is 70%.	
CONTRAST	Adjust the screen contrast 12...37. Default is 24.	
DIMMER	*ENABLED DISABLED	Enable the DIMMER to reduce the display BRIGHTNESS after the buttons are not pressed for the TIMEOUT period. Select the BRIGHTNESS level. Default is 10%. Press any button to awaken the transmitter and return to normal BRIGHTNESS. The buttons pressed will not be active for one second after the transmitter is awakened.
DIMMER LEVEL	NUMERIC 0-100%	
TIMEOUT	5 MINUTES *10 MINUTES 20 MINUTES 30 MINUTES 60 MINUTES	

Information Menu

An asterisk (*) indicates the parameter default.

Information Submenus	Options/Descriptions
VENDOR	BADGER METER
MODEL	TFX-500w
P.N.:	Badger Meter 24-character part number
S.N.	Serial Number
FW VERSION	Firmware Version xx.xx.xx
CAL. DATE	Calibration Date YYYY-MM-DD
DATE CODE	Manufacture Date YYYY-MM-DD
TAG ID	16 characters

Diagnostics Menu

Diagnostics Submenus	Options/Descriptions	
<i>SIGNAL STRENGTH</i>	Read-only numeric with message to indicate the quality of the ultrasonic signal.	
<i>HISTORY</i>	Chronological list of 30 past errors, alarms and warning messages.	
<i>DELTA TIME FILTERED</i>	Read-only ##.## ns.	
<i>FLOW RATE RAW</i>	Read-only unfiltered flow rate.	
<i>FLUID SOUND SPEED</i>	Read-only; Units same as <i>VELOCITY</i> ; Measured ultrasound speed of the fluid.	
<i>DELTA TIME RAW</i>	Read-only ns.	
<i>CURRENT OUTPUT</i>	Read-only mA.	
<i>OUTPUT #1 STATUS</i>	*ON	Status of digital output. If the output mode is <i>ALARM</i> or <i>FLOW DIRECTION</i> , then the output status <i>ON</i> or <i>OFF</i> is indicated. Frequency and Pulse modes can operate too fast to view the <i>ON</i> and <i>OFF</i> state, so the mode is shown for the status.
	OFF	
	FREQUENCY	
	PULSE	
	DISABLED	
<i>OUTPUT #2 STATUS</i>	ON	
	OFF	
	FREQUENCY	
	PULSE	
	DISABLED	
<i>INPUT STATUS</i>	ON	
	OFF	
<i>TOTAL OVERFLOW COUNT</i>	Numeric integer	The <i>TOTAL OVERFLOW COUNT</i> increments each time the flow total exceeds the digits in the display.
<i>PASSCODE LEVEL</i>	READ ONLY OPERATOR SERVICE ADMIN RECOVERY	Defines the parameters, screens and actions available to a user.
<i>CLEAR HISTORY</i>	CLEAR HISTORY confirmation screen.	Clears all alarms, warnings, errors and informational messages from the <i>ALARM HISTORY</i> buffer. This is typically done after startup or maintenance on the flow system is successfully completed.
<i>FACTORY RESET</i>	FACTORY RESET confirmation screen.	Resets all parameters to the values on the device when it was shipped from the factory. Any settings made will be reset.
<i>REBOOT</i>	REBOOT confirmation screen.	Reboots the device. The TFX-500w meter does not require this manual <i>REBOOT</i> for any procedure, but it may be useful for system troubleshooting.

Reset Menu

Reset Submenus	Options/Descriptions
<i>RESET FLOW TOTAL</i>	Reset the <i>FLOW TOTAL</i> . See the " <i>Reset Flow Totalizer Procedure</i> " below.
<i>UNLATCH ALARMS</i>	Only available if alarm latch is enabled. Unlatches output if alarm condition occurred and cleared. See " <i>Setup > Inputs/Output > Output #1 (or Output #2)</i> " on page 28.

Reset Flow Totalizer Procedure

The flow meter accumulates the amount of flow passing through the meter into a flow totalizer. To reset the flow total:

1. Press **MENU/BACK**.
2. Select **RESET** from the *Main Menu*.
(Press **DOWN** to scroll through the list of options. When *RESET* is the top item, press **ENTER**.)
3. Select **RESET FLOW TOTAL** from the *Reset menu*.
(With *RESET FLOW TOTAL* as the top item, press **ENTER**.)
4. Select **OK** to confirm reset.

After selecting *RESET FLOW TOTAL*, you are prompted to confirm the reset of the flow total. Press **ENTER** to confirm or press **MENU/BACK** to cancel.

TROUBLESHOOTING

Warning and alarm messages are classified according to NAMUR 107 standards.

Out of Specification Messages

Warning and alarm messages occur when the flow meter is operational, but the readings might be out of specification or an operator might need to take action. If a warning or alarm condition occurs, a warning/alarm icon with code will appear in the at the bottom of the *Home Screen*. The flow rate and flow total will continue to be displayed.

Error Messages

An error condition occurs when the flow rate cannot be determined, such as when the signal strength is too low. If an error condition occurs, the flow rate will be replaced with the "failed" icon, code and description.

If conditions cause multiple messages to occur, all messages will be saved to the history, but some messages may not be displayed. If an error condition occurs, warning and alarm messages will not be displayed. If multiple errors occur, each error message will cycle through and be viewable for 5 seconds. Similarly if multiple warning or alarm conditions occur (but no error conditions), each message will cycle through and be viewable for 5 seconds.

Warning, Alarm and Error Messages automatically clear when the issue clears.

Check Function Codes

When the meter or outputs are in a test mode, a check function message appears at the bottom of the *Home Screen*.

View Alarm and Message Buffer

Up to 30 alarm or warning message codes are buffered on a first-in-first-out basis. To view the buffer, go to *DIAGNOSTICS > HISTORY*.

Warning and Alarm Message Codes

Failure Codes

Code	Description	Correction
F01 blank screen	Firmware error. Cannot boot up.	<ul style="list-style-type: none"> Update firmware Send in transmitter for repair or replace transmitter This message is not stored in the <i>ALARM HISTORY</i>
F02 ELECTRONIC ERROR	Multiple watchdog timeout.	<ul style="list-style-type: none"> Contact factory Message remains until firmware is updated Update firmware Repair or replace transmitter
F03 ELECTRONIC ERROR	Hardware error.	<ul style="list-style-type: none"> Error remains until the transmitter is rebooted. Reboot transmitter If error repeats, repair or replace transmitter
F10 LOW SIGNAL	Signal strength is below cutoff	<ul style="list-style-type: none"> Empty pipe Improper programming/incorrect parameter values Improper transducer spacing Non-homogeneous pipe wall To test the meter off the flow system, you can cap a short section pipe and fill with it with water. Then set up and test the meter. Although no flow will occur, there should be a signal
F11 HIGH SIGNAL	Signal strength is oversaturated	<ul style="list-style-type: none"> Change transducer mounting from V-mount to W-mount or Z-mount to V-mount Enable shunt resistor

Check Function Codes

Code	Description	Correction
C01 CURRENT TEST	Current output is in test mode	Change Current Output from Test Mode
C10 OUTPUT #1 FREQUENCY TEST	Output #1 is in frequency test mode	Change Output #1 from Test Mode
C20 OUTPUT #2 FREQUENCY TEST	Output #2 is in frequency test mode	Change Output #2 from Test Mode

Out-of-Specification Codes

Code	Description	Correction
S01 ELECTRONIC WARNING	Fault detected and meter rebooted.	<ul style="list-style-type: none"> • Contact factory • Update firmware • Repair or replace transmitter
S02 DEFAULT FAILED	Reset to factory defaults failed.	<ul style="list-style-type: none"> • Check calibration. If it does not match the calibration settings on the transducer serial tag, enter field calibration settings. Return to the <i>Home Screen</i> and continue to operate (if the reset to factory defaults is through the transmitter)
S10 mA TOO HIGH	Flow rate higher than flow rate at 20 mA output.	<ul style="list-style-type: none"> • Check the scaling of the current output • Check flow conditions
S20 FREQ #1 HIGH S21 FREQ #2 HIGH	Flow rate higher than maximum flow rate of frequency output.	<ul style="list-style-type: none"> • Check the scaling of the frequency output of either digital Output #1 or Output#2 • Check flow conditions
S30 PULSE #1 HIGH S31 PULSE #2 HIGH	Pulse output is triggered too fast for the pulse width.	<ul style="list-style-type: none"> • Check the scaling factor of the pulse output. Increasing the scaling factor will trigger the pulse less frequently • Check the units of the flow total • Reduce the pulse width if the device receiving the pulse still can detect the pulse
S40 HIGH FLOW S41 HIGH FLOW	Flow rate is above high flow alarm setting for output #1 (S40) or output #2 (S41) in transmitter.	<ul style="list-style-type: none"> • Check flow rate displayed on transmitter • If flow rate appears to be correct and alarm should not be triggered, check <i>SET HIGH</i> parameter • If flow rate does not appear to be correct, follow the actions for symptom "Flow reading appears to be incorrect"
S45 LOW FLOW S46 LOW FLOW	Flow rate is below low flow alarm setting for output #1 (S45) or output #2 (S46) in transmitter.	<ul style="list-style-type: none"> • Check flow rate displayed on transmitter • If flow rate appears to be correct and alarm should not be triggered, check <i>SET LOW</i> parameter of the output • If flow rate does not appear to be correct, follow the actions for symptom "Flow reading appears to be incorrect"
S50 TOTAL OVERFLOW	Accumulated flow total is greater than viewable digits and caused the totalizer to rollover. The overflow counter increments when there is a rollover condition.	<ul style="list-style-type: none"> • Check the totalizer units and change to a larger unit (for example, cubic meters instead of liters) • Reset the flow total to clear the overflow counter

Informational Events Codes

Information events are only displayed in the ALARM HISTORY and not on the *Home Screen*.

I01 POWER ON	Power on or rebooted
I11 ZERO	Meter zeroed
I12 FACTORY CALIBRATION	Calibration changed from Field to Factory
I13 FIELD CALIBRATION	Calibration changed from Factory to Field
I21 FIRMWARE CHANGED	Firmware updated
I31 FLOW TOTAL RESET	Flow total reset to zero

Symptoms

Symptom: Transmitter does not power up.

Possible Causes	Recommended Action
<ul style="list-style-type: none"> No power or inadequate power Blown fuse (AC Model only) Display ribbon cable not seated properly 	<ul style="list-style-type: none"> Measure voltage at the power terminals and check that the voltage matches the labels by the power terminals. Check the fuse near the power terminals. If fuse is blown, verify the voltage and polarity is correct and reset the fuse. Inspect ribbon cable connections. LED's on power board will light up with no LCD display. Replace the transmitter if the above actions do not resolve the issue.

Symptom: Flow reading appears to be incorrect.

Possible Causes	Recommended Action
<ul style="list-style-type: none"> Incorrect positioning of transducers Poor contact between transducers and pipe Poor placement of transducers Low signal strength Process loop issues Incorrect pipe settings Meter not calibrated? Display not set up correctly 	<p>Refer to the Transducer Mounting Configuration section for details on proper installation.</p> <p>At the transducer:</p> <ul style="list-style-type: none"> Verify that the spacing of the transducers is set correctly. On most transducers, a scribe mark on the side of the transducers indicates the point of measurement—NOT from the end points of the transducers. Verify that the transducers are aligned correctly. For Z-Mount, verify the transducers are 180° from each other. Make sure there is a good contact between the transducers and pipe and a thin coat of acoustic coupling is applied. For integral mount, check for over-tightening of the transducers. <p>Process loop and general location:</p> <ul style="list-style-type: none"> Make sure the transducers are on the sides of the pipe and NOT on the top of the pipe. Check that the transducers are NOT located at the highest point in the loop where air may accumulate. Check that the transducers are NOT on a downward flowing pipe unless adequate downstream head pressure is present to overcome partial filling or cavitation. Check that the transducers have adequate straight pipe upstream and downstream. Check process loop for entrained air or particulates which will impact the flow readings. Pipes may develop scale, product build-up or corrosion over time. As a result, the effective wall thickness may be different than a new pipe and wall thickness or liner parameters may need to be adjusted. <p>At the transmitter:</p> <ul style="list-style-type: none"> Verify that pipe parameters match the installation.

Symptom: Unstable flow.

Possible Causes	Recommended Action
<ul style="list-style-type: none"> Installation issues Flow instability Transducers mounting is loose Transducers are moved 	<ul style="list-style-type: none"> Check process loop for variations of entrained air which will impact the flow Check for pump induced flow instability. Check that the transducers are secure and are in area where the transducers will not be inadvertently bumped or disturbed.

Symptom: Flow readout is opposite of the flow direction.

Possible Causes	Recommended Action
<ul style="list-style-type: none"> Integral mount transmitter is mounted in reverse flow direction so display is properly oriented Up and down transducers wiring reversed Flow direction parameter is reversed 	<ul style="list-style-type: none"> Change the transducer flow direction parameter. Rewire the up and down transducers to the transmitter.

Symptoms: Current, frequency or pulse outputs do not match the readings.

Possible Causes	Recommended Action
<ul style="list-style-type: none"> Incorrect parameter settings Wiring or control system configuration issues 	<p>Verify that the parameters for the output are set properly.</p>

FRONT PANEL REPLACEMENT

A replacement front panel is available and includes the front cover, display/keypad/overlay, main board, connectors and shield. The front panel is a single piece and is easily removed by unscrewing the four enclosure screws.

Main Board Replacement

Replacing the *complete* transmitter or the front panel as a *single piece* is the preferred method. However, you can replace only the main board, if necessary. Instructions follow.

CAUTION

CONTAINS PARTS AND ASSEMBLIES SUSCEPTIBLE TO DAMAGE BY ELECTROSTATIC DISCHARGE (ESD). BEFORE PICKING UP AN ESD-SENSITIVE ELECTRONIC COMPONENT, DISCHARGE YOURSELF BY TOUCHING A GROUNDED BARE METAL SURFACE OR APPROVED ANTI-STATIC MAT.



OBSERVE PRECAUTIONS FOR HANDLING ELECTROSTATIC-SENSITIVE DEVICES.

Tools Required

- A Philips #2 screwdriver
- A flat blade screwdriver
- Tweezers for electronics
- A workbench that prevents ESD damage to the electronics

To remove the main board:

1. Completely loosen and remove the four captive screws on the transmitter cover. Lift and remove the cover and place it face down on a stable work surface.

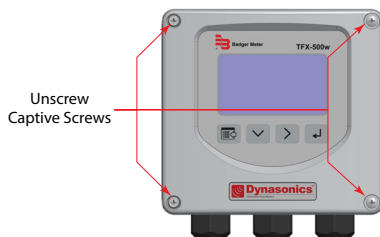

Figure 31: Captive cover screws



Figure 32: Remove cover from base

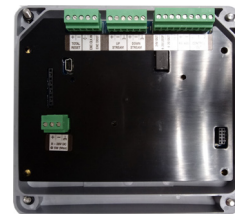

Figure 33: Lay cover face down

2. Remove the terminal blocks from the board.
3. Remove the four screws holding the shield and main board in place. The main board will remain in place.
4. Remove the PCB shield from the board and set it aside.



Figure 34: PCB shield removed

5. On the left side of the board at J501, gently slide the keypad ribbon cable retainer away from the center of the board. Gently remove the keypad ribbon cable from the main board.

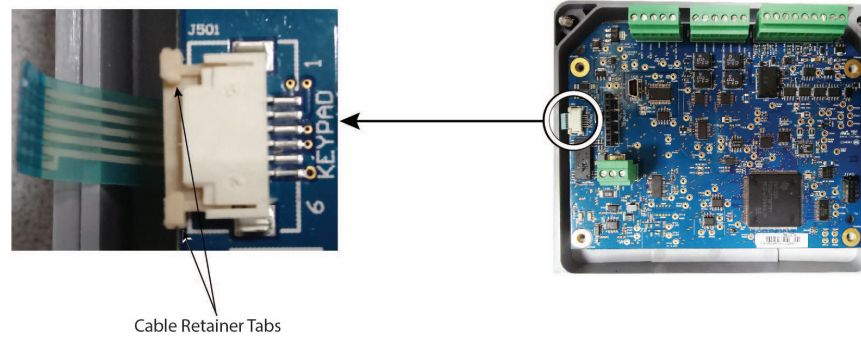

Figure 35: PCB shield removed

6. Pull the main board away from the front panel. There is a connector with long pins that connects the main board to the display board, so you will feel some friction but it should not require a lot of effort. Do NOT remove the display board as doing so will damage the display.

To install the main board:

1. While holding the main board, insert the keypad ribbon cable into the keypad ribbon cable connector at J501. You may need to use tweezers for electronics to insert the ribbon cable. Slide the cable retainer toward the center of the board to secure the keypad ribbon cable.
2. Align the pins on the display board to the holes on the main board and slide on the main board.
3. Re-install the shield and the four screws.
4. Reconnect the wiring to the terminal blocks.
5. Close the enclosure and tighten the four screws.

SPECIFICATIONS

System

Liquid Types	Water containing small amounts of suspended solids or gas bubbles	
Velocity Range	0.1...40 ft/s (0.03...12 m/s) bidirectional	
Flow Accuracy	DTTR/DTTN DTTC Easy Rail (DTTJ, DTTK)	±1% of reading or ±0.01 FPS (0.003 MPS), whichever is greater DTTC 3/4 in. and smaller are accurate to ± 1% full scale
Repeatability	±0.2% of reading	
Transducer Type	Clamp-on ultrasonics	
Certifications	Remote mount transmitter and integral mount transmitter with transducers	General Safety (option): FM Class 3810:2018, ANSI/ISA 61010-1:2012, ANSI/IEC 60529:2004, CAN/CSA-C22.2 No. 61010-1:2012, CSA C22.2 No. 60529:2005 CE: EMC Directive 2014/30/EU

Transmitter

Power Requirements	DC	Class II power supply is required; 9...28V DC @ 5 W maximum
	Protection	Reverse polarity and transient suppression
Display	Keypad	4-button navigation, membrane keypad with domed tactile feedback
	Resolution	128 × 64 pixel LED backlit graphical display; adjustable brightness and timeout
Enclosure	IP66; polycarbonate	
Ambient Temperature	Operational ambient	With display: -4...140° F (-20...60° C); without display: -40...158° F (-40...70° C)
	Storage	-40...176° F (-40...80° C)
Units of Measure	Velocity	feet/second, meters/second
	Totals	US Gallons, Million Gallons, Imperial Gallons, Million Imperial Gallons, Acre-Feet, Barrels, Liters, Hectoliters, Cubic Meters, Cubic Feet
	Flow rate	Acre Feet/Day, Liters/Second, Liters/Minute, Liters/Hour, Cubic Meters/Second, Cubic Meters/Minute, Cubic Meters/Hour, Cubic Feet/Minute, Cubic Feet/Second, Gallons/Second, Gallons/Minute, Gallons/Hour, Million Gallons/Day, Imperial Gallons/Second, Imperial Gallons/Minute, Imperial Gallons/Hour, Barrel/Minute, Million Imperial Gallons/Day, Barrel/Day
Mounting	Wall or pipe remote mount or integral mount; Enclosure can be rotated in 90° increments	
Inputs	Digital input	5...30V DC, externally or internally sourced; totalizer reset or alarm unlatch
Outputs	Pulse / Frequency / Digital /	Two outputs, each selectable as frequency, pulse, forward/reverse flow or alarm output; isolated open collector, 5...30V DC, externally or internally sourced with pullup resistor Digital alarm output: configurable high or low Frequency output: 0.5 Hz...16 kHz maximum Pulse (totalizer) output: 5 kHz maximum output open collector, pulse width 5...500 ms programmable
	Analog Output	0...20 mA and 4...20 mA drive up to 800 Ohms; minimum 16-bit resolution, isolated
Networks	EIA-485 with selectable protocols	Modbus RTU, baud rates 9600, 19200, 38400, 57600, 76800, 115200 BACnet MS/TP, baud rates 9600, 19200, 38400, 57600, 76800, 115200
	Endpoints	Connectivity to AquaCUE or BEACON cellular endpoints
Configuration Port	USB, Type mini-B	
Alarms	Buffer previous alarms, warnings or errors	
Languages	English, French, German and Spanish selectable	
Security	Four levels: Read-only, Operator, Service and Admin; 6-digit passcode number; selectable auto logout	

Transducers

Model	Construction	Cable Length	Pipe/Tubing Sizes	Pipe/Tubing Materials	Protection
DTTC	CPVC, Ultem, Nylon cord grip Polyethylene cable jacket; -40...194° F (-40...90° C)*	100 ft (90 m) max.	0.5...2 in. (12...50 mm)	Carbon steel, stainless steel, copper and plastic	NEMA 6/IP67
DTTR	PBT glass filled, Ultem®, Nylon cord grip PVC cable jacket; -40...250° F (-40...121° C)	300 ft (90 m) max.	2...10 in. (DN50...DN250)		NEMA 6/IP67
DTTN	CPVC, Ultem, Nylon cord grip Polyethylene cable jacket; -40...194° F (-40...90° C)	300 ft (90 m) max.	2...10 in. (DN50...DN250)		NEMA 6/IP67
DTTN Submersible	CPVC, Ultem, Nylon cord grip Polyethylene cable jacket; -40...194° F (-40...90° C)	300 ft (90 m) max.	2...10 in. (DN50...DN250)		NEMA 6P/IP68
Easy Rail (DTTJ/K)	PBT glass filled, Ultem®, Nylon cord grip PVC cable jacket; -40...250° F (-40...121° C)	100 ft (30 m) max.	2...6 in. (DN50...DN150) 2...10 in. (DN50...DN250)		NEMA 6/IP67

* DTTC integral mount temperature is limited by the transmitter temperature rating

Configuration Software

The flow meter can be programmed and configured with the SoloCUE Flow Device Manager software. The software also has troubleshooting tools for diagnosing and correcting installation problems.

SoloCUE	Used to configure and troubleshoot flow meter. Software is compatible with Windows® 7 SP1 or newer
----------------	--

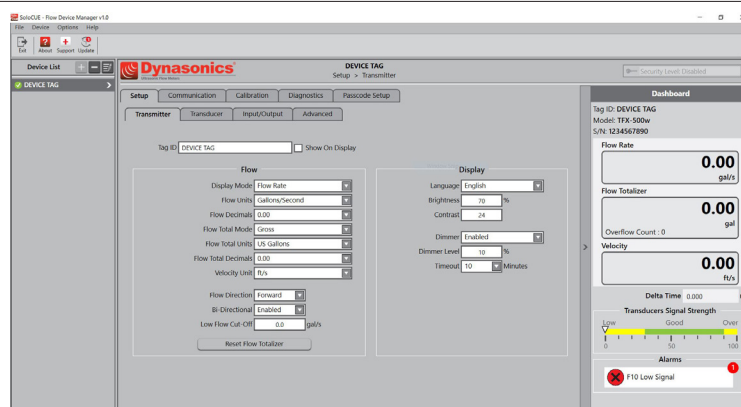

Figure 36: SoloCUE setup screen

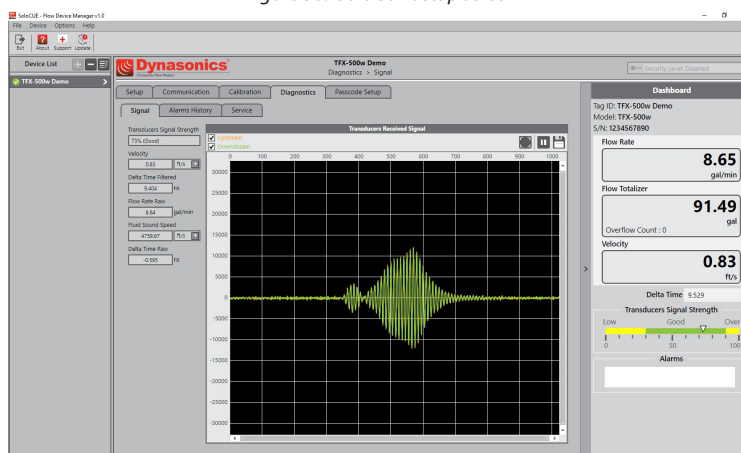

Figure 6: SoloCUE diagnostics screen

Additional Parts Required for Configuration

Part Number	Description
RC820648	USB Type A to mini B software cable (shielded to minimize noise)

PART NUMBER CONSTRUCTION



Transit Time: Pipes ≤ 2 in. (50 mm)

CERTIFICATION

General Area, CE

G

TRANSDUCER TYPE

- 1/2 in. ANSI pipe
- 3/4 in. ANSI pipe
- 1 in. ANSI pipe
- 1-1/4 in. ANSI pipe
- 1-1/2 in. ANSI pipe
- 2 in. ANSI pipe
- 1/2 in. Copper Tube
- 3/4 in. Copper Tube
- 1 in. Copper Tube
- 1-1/4 in. Copper Tube
- 1-1/2 in. Copper Tube
- 2 in. Copper Tube
- 1/2 in. Stainless Steel Tube
- 3/4 in. Stainless Steel Tube
- 1 in. Stainless Steel Tube
- 1-1/4 in. Stainless Steel Tube
- 1-1/2 in. Stainless Steel Tube
- 2 in. Stainless Steel Tube

- CA
- CB
- CC
- CD
- CE
- CF
- CG
- CH
- CT
- CJ
- CK
- CL
- CM
- CN
- CP
- CQ
- CR
- CS

TRANSMITTER TYPE

- 24V DC | Meter Mounted
- 24V DC | Remoted Mounted

- E
- F

DISPLAY

- Standard
- No display with keypad

- S
- W

REMOTE CABLE LENGTH

- None (Meter Mounted)
- 15 ft (4.57 m)
- 30 ft (9.14 m)
- 50 ft (15.24 m)
- 75 ft (22.86 m)
- 100 ft (30.48 m)

- WW
- AC
- AF
- AK
- AR
- BW

CONDUIT TYPE AND LENGTH ¹

- None
- 15 ft (4.57 m)
- 30 ft (9.14 m)
- 50 ft (15.24 m)
- 75 ft (22.86 m)
- 100 ft (30.48 m)

- WW
- AC
- AF
- AK
- AR
- BW

RESERVED

- Standard

S

UNITS OF MEASURE: TOTALIZER / FLOW RATE

- Gallons/gallons per minute
- Gallons/cubic feet per minute
- Cubic Meters/cubic meters per minute
- Cubic Meters/cubic meters per hour
- Cubic Feet/gallons per minute
- Cubic Feet/cubic feet per minute
- Liters/liters per second
- Liters/liters per minute
- Liters/liters per hour
- Million Gallons/gallons per minute
- Acre Feet/gallons per minute

- G
- B
- T
- H
- F
- J
- N
- P
- Q
- M
- A

TESTING & TAGGING

- Factory Calibrated
- Factory Calibrated/ID Tag

- F
- S

¹ Conduit length must be less than or equal to cable length. Submersible Conduit limited to 100 ft (30 m).



Transit Time: Pipes ≥ 2 in. (50 mm)

CERTIFICATIONS

General Area, CE

G

TRANSDUCER TYPE

Easy Rail | 2 ... 6 in. (50...150 mm) Pipes

JZ

Easy Rail | 6 ... 10 in. (150... 300 mm) Pipes

KZ

DTTN | Medium Pipes

NZ

DTTN (Submersible) | Medium Pipes

WZ

DTTR | Medium Pipes

RZ

TRANSMITTER TYPE

24V DC Remote Mounted

F

DISPLAY

Standard

S

No display with keypad

W

REMOTE CABLE LENGTH

15 ft (4.57 m)

AC

30 ft (9.14 m)

AF

50 ft (15.24 m)

AK

75 ft (22.86 m)

AR

100 ft (30.48 m)

BW

150 ft (45.72 m)

BK

200 ft (60.96 m)

DW

250 ft (76.20 m)

DK

300 ft (91.44 m)

EW

CONDUIT AND CABLE LENGTH ¹

None

WW

15 ft (4.57 m)

AC

30 ft (9.14 m)

AF

50 ft (15.24 m)

AK

75 ft (22.86 m)

AR

100 ft (30.48 m)

BW

150 ft (45.72 m)

BK

200 ft (60.96 m)

DW

250 ft (76.20 m)

DK

300 ft (91.44 m)

EW

RESERVED

Standard

S

UNITS OF MEASURE: TOTALIZER / FLOW RATE

Gallons/gallons per minute

G

Gallons/cubic feet per minute

B

Cubic Meters/cubic meters per minute

T

Cubic Meters/cubic meters per hour

H

Cubic Feet/gallons per minute

F

Cubic Feet/cubic feet per minute

J

Liters/liters per second

N

Liters/liters per minute

P

Liters/liters per hour

Q

Million Gallons/gallons per minute

M

Acre Feet/gallons per minute

A

TESTING & TAGGING

Factory Calibrated

F

Factory Calibrated/ID Tag

S

¹ Conduit length must be less than or equal to cable length. Submersible Conduit limited to 100 ft (30 m).

NORTH AMERICAN PIPE SCHEDULES

Steel, Stainless Steel, PVC Pipe, Standard Classes

NPS in.	OD in.	SCH 60		X STG.		SCH 80		SCH 100		SCH 120/140		SCH 180					
		ID in.	Wall in.	ID in.	Wall in.	ID in.	Wall in.	ID in.	Wall in.	ID in.	Wall in.	ID in.	Wall in.				
1	1.315	—	—	0.957	0.179	0.957	0.179	—	—	—	—	0.815	0.250				
1.25	1.660			1.278	0.191	1.278	0.191					1.160	0.250				
1.5	1.900			1.500	0.200	1.500	0.200					1.338	0.281				
2	2.375			1.939	0.218	1.939	0.218					1.687	0.344				
2.5	2.875			2.323	0.276	2.323	0.276					2.125	0.375				
3	3.500			2.900	0.300	2.900	0.300					2.624	0.438				
3.5	4.000	—	—	3.364	0.318	3.364	0.318	—	—	—	—	—	—				
4	4.500			3.826	0.337	3.826	0.337							3.624	0.438	3.438	0.531
5	5.563			4.813	0.375	4.813	0.375							4.563	0.500	4.313	0.625
6	6.625			5.761	0.432	5.761	0.432							5.501	0.562	5.187	0.719
8	8.625	7.813	0.406	7.625	0.500	7.625	0.500	7.437	0.594	7.178	0.719	6.183	1.221				
10	10.75	9.750	0.500	9.75	0.500	9.562	0.594	9.312	0.719	9.062	0.844	8.500	1.125				

Table 1: Steel, stainless steel, PVC pipe, standard classes

Steel, Stainless Steel, PVC Pipe, Standard Classes (continued)

NPS in.	OD in.	SCH 5		SCH 10 (Lt Wall)		SCH 20		SCH 30		STD		SCH 40	
		ID in.	Wall in.	ID in.	Wall in.	ID in.	Wall in.	ID in.	Wall in.	ID in.	Wall in.	ID in.	Wall in.
1	1.315	1.185	0.065	1.097	0.109	—	—	—	—	1.049	—	1.049	0.133
1.25	1.660	1.53	0.065	1.442	0.109					1.380		1.380	0.140
1.5	1.900	1.77	0.065	1.682	0.109					1.610		1.610	0.145
2	2.375	2.245	0.065	2.157	0.109					2.067		2.067	0.154
2.5	2.875	2.709	0.083	2.635	0.120					2.469		2.469	0.203
3	3.500	3.334	0.083	3.260	0.120					3.068		3.068	0.216
3.5	4.000	3.834	0.083	3.760	0.120	—	—	3.548	—	3.548	0.226		
4	4.500	4.334	0.083	4.260	0.120			4.026	0.237	4.026	0.237		
5	5.563	5.345	0.109	5.295	0.134			5.047	0.258	5.047	0.258		
6	6.625	6.407	0.109	6.357	0.134			6.065	0.280	6.065	0.280		
8	8.625	8.407	0.109	8.329	0.148	8.125	0.250	8.071	0.277	7.981	0.322	7.981	0.322
10	10.75	10.482	0.134	10.42	0.165	10.25	0.250	10.13	0.310	10.02	0.365	10.02	0.365

Table 2: Steel, stainless steel, PVC pipe, standard classes (continued)

Copper Tubing, Copper and Brass Pipe, Aluminum

Nominal Diameter in.	Copper Tubing in.			Copper & Brass Pipe in.	Alum. in.	Nominal Diameter in.	Copper Tubing in.			Copper & Brass Pipe in.	Alum. in.			
	Type						Type							
	K	L	M				K	L	M					
0.5	OD	0.625	0.625	0.625	0.840	—	3-1/2	OD	3.625	3.625	3.625	4.000	—	
	Wall	0.049	0.040	0.028	0.108			Wall	0.120	0.100	0.083	0.250		
	ID	0.527	0.545	0.569	0.625			ID	3.385	3.425	3.459	3.500		
0.6250	OD	0.750	0.750	0.750	—	—	4	OD	4.125	4.125	4.125	4.500	4.000	
	Wall	0.049	0.042	0.030				Wall	0.134	0.110	0.095	0.095	0.250	
	ID	0.652	0.666	0.690				ID	3.857	3.905	3.935	3.935	4.000	
0.75	OD	0.875	0.875	0.875	1.050	—	4-1/2	OD	—	—	—	—	5.000	
	Wall	0.065	0.045	0.032	0.114			0.250						
	ID	0.745	0.785	0.811	0.822			4.500						
1	OD	1.125	1.125	1.125	1.315	—	5	OD	5.125	5.125	5.125	5.563	5.000	
	Wall	0.065	0.050	0.035	0.127			Wall	0.160	0.125	0.109	0.250	0.063	
	ID	0.995	1.025	1.055	1.062			ID	4.805	4.875	4.907	5.063	4.874	
1.25	OD	1.375	1.375	1.375	1.660	—	6	OD	6.125	6.125	6.125	6.625	6.000	
	Wall	0.065	0.055	0.042	0.146			Wall	0.192	0.140	0.122	0.250	0.063	
	ID	1.245	1.265	1.291	1.368			ID	5.741	5.845	5.881	6.125	5.874	
1.5.	OD	1.625	1.625	1.625	1.900	—	7	OD	—	—	—	—	7.625	7.000
	Wall	0.072	0.060	0.049	0.150			0.282					0.078	
	ID	1.481	1.505	1.527	1.600			7.062					6.844	
2	OD	2.125	2.125	2.125	2.375	—	8	OD	8.125	8.125	8.125	8.625	8.000	
	Wall	0.083	0.070	0.058	0.157			Wall	0.271	0.200	0.170	0.313	0.094	
	ID	1.959	1.985	2.009	2.062			ID	7.583	7.725	7.785	8.000	7.812	
2.5	OD	2.625	2.625	2.625	2.875	2.500	10	OD	10.125	10.125	10.125	10.000	—	
	Wall	0.095	0.080	0.065	0.188	0.050		Wall	0.338	0.250	0.212	0.094	—	
	ID	2.435	2.465	2.495	2.500	2.400		ID	9.449	9.625	9.701	9.812	—	
3	OD	3.125	3.125	3.125	3.500	3.000								
	Wall	0.109	0.090	0.072	0.219	0.050								
	ID	2.907	2.945	2.981	3.062	2.900								

Table 3: Copper tubing, copper and brass pipe, aluminum

Cast Iron Pipe, Standard Classes, 3...10 inch

Size in.		Class in.							
		A	B	C	D	E	F	G	H
3	OD	3.80	3.96	3.96	3.96	—	—	—	—
	Wall	0.39	0.42	0.45	0.48				
	ID	3.02	3.12	3.06	3.00				
4	OD	4.80	5.00	5.00	5.00	—	—	—	—
	Wall	0.42	0.45	0.48	0.52				
	ID	3.96	4.10	4.04	3.96				
6	OD	6.90	7.10	7.10	7.10	7.22	7.22	7.38	7.38
	Wall	0.44	0.48	0.51	0.55	0.58	0.61	0.65	0.69
	ID	6.02	6.14	6.08	6.00	6.06	6.00	6.08	6.00
8	OD	9.05	9.05	9.30	9.30	9.42	9.42	9.60	9.60
	Wall	0.46	0.51	0.56	0.60	0.66	0.66	0.75	0.80
	ID	8.13	8.03	8.18	8.10	8.10	8.10	8.10	8.00
10	OD	11.10	11.10	11.40	11.40	11.60	11.60	11.84	11.84
	Wail	0.50	0.57	0.62	0.68	0.74	0.80	0.86	0.92
	ID	10.10	9.96	10.16	10.04	10.12	10.00	10.12	10.00

Table 4: Cast iron pipe, standard classes, 3...10 inch

INTENTIONAL BLANK PAGE

Control. Manage. Optimize.

Dynasonics, AquaCUE and SoloCUE are registered trademarks of Badger Meter, Inc. Other trademarks appearing in this document are the property of their respective entities. Due to continuous research, product improvements and enhancements, Badger Meter reserves the right to change product or system specifications without notice, except to the extent an outstanding contractual obligation exists. © 2018 Badger Meter, Inc. All rights reserved.

www.badgermeter.com

The Americas | Badger Meter | 4545 West Brown Deer Rd | PO Box 245036 | Milwaukee, WI 53224-9536 | 800-876-3837 | 414-355-0400
México | Badger Meter de las Americas, S.A. de C.V. | Pedro Luis Ogazón N°32 | Esq. Angelina N°24 | Colonia Guadalupe Inn | CP 01050 | México, DF | México | +52-55-5662-0882
Europe, Eastern Europe Branch Office (for Poland, Latvia, Lithuania, Estonia, Ukraine, Belarus) | Badger Meter Europe | ul. Korfantego 6 | 44-193 Knurów | Poland | +48-32-236-8787
Europe, Middle East and Africa | Badger Meter Europa GmbH | Nurtlinger Str 76 | 72639 Neuffen | Germany | +49-7025-9208-0
Europe, Middle East Branch Office | Badger Meter Europe | PO Box 341442 | Dubai Silicon Oasis, Head Quarter Building, Wing C, Office #C209 | Dubai / UAE | +971-4-371 2503
Slovakia | Badger Meter Slovakia s.r.o. | Racianska 109/B | 831 02 Bratislava, Slovakia | +421-2-44 63 83 01
Asia Pacific | Badger Meter | 80 Marine Parade Rd | 21-06 Parkway Parade | Singapore 449269 | +65-63464836
Switzerland | Badger Meter Swiss AG | Mittelholzerstrasse 8 | 3006 Bern | Switzerland | +41-31-932 01 11