



The Standard of Measurement

TCS 3000 REGISTER



Setup & Operation Manual

Table of Contents

Table of Contents	2	Pump Control	18
Receipt & Inspection Notice	3	Speed Control 1	18
Introduction	4	Speed Control 2	18
System Specifications	4	Pump Starter	18
TCS 3000 Start Up	5	Pump Stabilization	18
Navigation	5	Valve Type	19
Navigation (Continued)	6	S1 - S2 Delay	19
Display Icons	6	Max Flowrate	19
Select Functions	7	S2 Flow	19
Start Delivery	7	Pulser Type	19
Show Last Delivery	8	Pulse Estimate	19
Begin or End Shift	8	Product Units	19
View Inventory	8	Hose Volume	19
Duplicate Shift Ticket	9	Max Pulse Error	20
Re-Print Tickets	9	Additive Injector	20
System Menu	9	Begin Recalibration	21
Reports	10	Full Calibration	21
Operating Parameters	10	Add Point	21
Show Prover Status	10	Edit Product Calibration	21
Last Prover Ticket	10	TCS Calibration Factors	22
Prover Ticket	10	Add New Product	22
Meter Info	10	Remove Product	22
Version Info	10	Hose Charge	22
Memory Status	10	Accounting	23
Print Error Log	10	Next Ticket Number	23
Checksums	10	Require Ticket Print	23
Preview Prover Ticket	10	Configure Tickets	23
Preview Error Log	10	Configure Tickets (Cont.)	24
System Settings	11	Delivery Screens	25
Display Settings	11	Delivery Screens (Cont.)	26
Printer Settings	11	System Metrics	26
Enable / Disable Printer	11	Temp Probe	27
Select Printer	12	Meter Information	27
Enable / Disable Host	12	Prover Ticket	27
Clients Address Range	12	Ticket Cleanup	27
Regional Settings	12	Reset Totalizers	28
Date/Time	12	Enable Remote Config	28
Decimal/Comma	12	Pulse Tracker	28
Delivery Settings	12	Product Settings	29
Preset Settings	12	Inventory	29
Multiple Deliveries	13	Product Prices	29
Customer ID	13	Product Prices (Continued)	30
Display Precision	13	Activate Product	31
Zero-Flow Timeout	13	Deactivate Product	31
Pause Options	13	Product Timing	31
Auxiliary Devices	13	Preset Timing	31
External Display	13	Air Eliminator Hold	31
External Display (Continued)	14	Startup Volume	31
Air Elimination	14	Auxiliary Settings	32
Pulser Output	14	Additive Injector	32
RFID Reader	14	Corrected Differential Pressure	32
Analog Input	15	Pressure Sensor	32
Level Meters	15	Filter Capacity	32
Pressure Sensors	15	Product Lists	32
Connectivity	16	Advanced Functions	33
Network Settings	16	System Shutdown	33
Printer Settings	16	System Update	33
Configure Ticket Headers/Footers	16	Daisy Chain	34
Misc. Settings	16	Daisy Chain (Continued)	35
Level 1 Password	16	Inventory How To	36
Level 2 Password	16	Temperature Probe Calibration	37
Access Key	16	Trouble Shooting	38
System Mode	16	Trouble Shooting Hardware/Software	39
User Database Update	16	Trouble Shooting Hardware/Software (Continued)	40
Weights & Measure (W&M) Settings	17	Trouble Shooting System Settings	41
Products	17	Trouble Shooting System Settings (Continued)	41
Recalibrate Product	17	Trouble Shooting W & M Settings	42
Modify Parameters	17	Trouble Shooting W & M Settings (Continued)	42
Product Name	17	Trouble Shooting Product Settings	45
Comp. Table	17	Trouble Shooting Radio Modems	45
6B Comp. Table Param.	17	Trouble Shooting 3G/4G Modems	45
24 Comp. Table Param.	18	TCS 3000 Register Parts Breakdown	46
54B Comp. Table Param.	18	Warranty	47
Mass Density	18		

Receipt & Inspection

Upon receipt of register shipment, be sure to inspect the packaging and the register assembly for any damage before signing the receipt of the shipment. Notify the delivery company about possible damage and refuse receipt of the shipment.

Registers are individually boxed and are protected with static resistant packing material. Each package is identified with the register assembly part number, description, serial number. Verify the register model is the correct model, size, and configuration as ordered. Contact your distributor if there is any discrepancy or question.

Register assemblies should be handled with appropriate methods for the size and weight involved. Appropriate clothing and shoes need to be utilized. Transport the register package to the installation site with appropriate transportation methods, careful not to damage the register.

Be careful of any loose or protruding staples from the packaging, as they can be very sharp and may potentially cause injury.

If foam has been used to protect register, carefully remove top foam layer before attempting to remove register assembly from box. Foam packaging maybe formed around the register assembly making it difficult to remove. Do not lift the register assembly by wires or anything other than the metal body of the register. Do not insert objects or cables into the register unless stated. Removing register assembly from packaging without adhering these warnings may cause serious injury to you and/or the register.

Appropriate precautions should be taken regarding any personal, environmental and material compatibility with the end use system.

Notice

Total Control Systems (TCS) shall not be liable for technical or editorial errors in this manual or omissions from this manual. TCS makes no warranties, express or implied, including the implied warranties of merchantability and fitness for a particular purpose with respect to this manual and, in no event, shall TCS be liable for special or consequential damages including, but not limited to, loss of production, loss of profits, etc.

The contents of this publication are presented for informational purposes only, and while every effort has been made to ensure their accuracy, they are not to be construed as warranties or guarantees, expressed or implied, regarding the products or services described herein or their use or applicability. We reserve the right to modify or improve the designs or specifications of such products at any time.

TCS does not assume responsibility for the selection, use or maintenance of any product. Responsibility for proper selection, use and maintenance of any TCS product remains solely with the purchaser and end-user.

All rights reserved. No part of this work may be reproduced or copied in any form or by any means – graphic, electronic or mechanical – without first receiving the written permission of Total Control Systems, Fort Wayne, Indiana USA.

Introduction

The TCS 3000 register is a fully integrated custody transfer flow computer that will control a majority of the vehicle delivery operations. The Open Software Architecture provides the option of a simple “*Pump & Print*” delivery or a custom measurement solution. The TCS 3000 features a 4.5”x 3.5” full color VGA display screen, multiple delivery screens and a flexible mounting with backlit alpha-numeric keypad for the user interface. Software features offer complete flexibility of delivery screen information and view, preset, price/tax, ticket format and password protection. Available in flexible mounting configurations of 75 or 90 degree displays for meter mounting, and a remote mounting.

As a flow computer with open software architecture, there will always be a need to add features to the register as the industry applications evolve. Therefore please be reminded to contact the factory for periodic updates.

Optional GPS, Bluetooth, Wi-Fi and Cellular capability enables the TCS 3000 to improve your product security and ease access to your delivery data to reduce your operation costs. Many additional features are available (multiple product delivery, additive injection, density/temperature correction, multiple valve & pump control, etc.) to enhance your measurement solution.

TCS 3000 - This manual will help guide you with the setup confirmation and calibration of the register. Additional information will be provided for wiring instruction and auxiliary devices to integrate into the register.

System Specifications

ELECTRICAL

Power:	12 - 24Vdc A 7.5 amp fuse is provided to limit the 12VDC power source.
Current:	1.4 Amp
Solid State Relays:	12 - 24 Vdc; Passive Solid State

INTERNAL PULSER

Pulse Ratio	400:1 PPR; Quadrature
Power	5 Vdc
Hertz	0 - 5000 Hz

EXTERNAL PULSE INPUT

Type	Single or Dual Channel (Quadrature)
Power	5 Vdc

ENCLOSURE

Aluminum die cast with epoxy powder coat	IP 66 / NEMA 4 rated
UL/cUL Rating	Class 1, Division 2, Group C + D
Ports:	Ten 1/2” NPT UL, cUL threaded connection ports, Optional ten M20 threaded connection ports
Temperature Range:	-40 F to 158 F (-40 C to 70 C)

Backlit LED Keypad
Calibration optical switch, password and mechanical seal

COMMUNICATION

Two (2) RS 485 output, 2-wire half duplex, custom protocol; 9600 baud, 8 bit, no parity, 1 stop bit
Three (3) RS 232 output, 9600 baud; 8 bit, no parity, 1 stop bit

The USB0 and USB1 ports are for maintenance only. To access these USB ports, power to the unit is to be disconnected or the area known to be free of ignitable gas or equivalent.

WARNINGS:

WARNING– EXPLOSION HAZARD– DO NOT DISCONNECT EQUIPMENT WHILE THE CIRCUIT IS LIVE OR UNLESS THE AREA IS KNOWN TO BE FREE OF IGNITABLE CONCENTRATIONS

WARNING– EXPLOSION HAZARD– SUBSTITUTION OF ANY COMPONENT MAY IMPAIR SUITABILITY FOR CLASS 1, DIVISION 2.

TCS 3000 Register Start Up:

Caution

Before Placing this product into service, make sure that the register has been properly calibrated and setup for the type of fluid being measured. This includes calibration factor, compensation type, compensation parameter, product type, valve settings, no flow timeout and others. Refer to the operation manual supplied with the register for instructions. Failure to properly calibrate and setup the register can result in unexpected operation, inaccurate measurements and damage to equipment or property.



SHIFT + MODE (SAME TIME) = SYSTEM MENU

Navigation Keyboard Functions

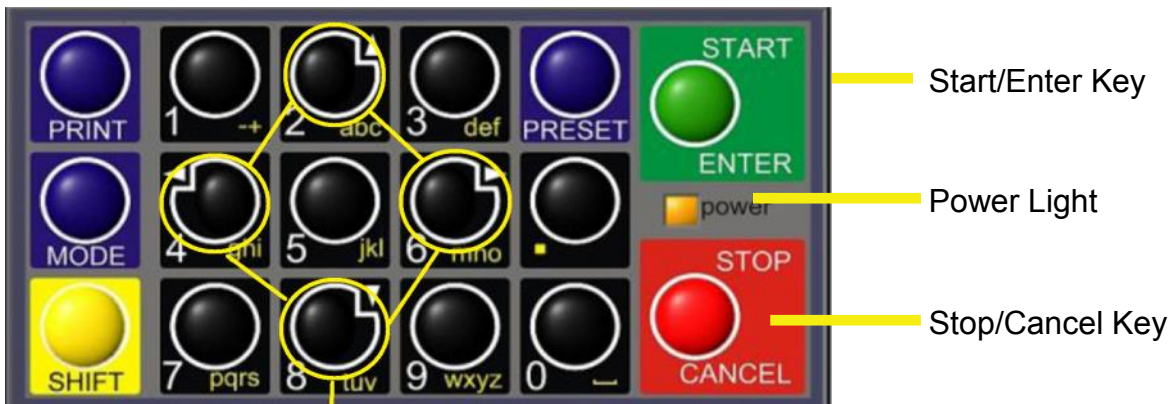

Arrow Keys

- | | |
|-----------------|---|
| Power Light | Allows you to see that there is power to the electronic register. |
| Start/Enter Key | Allows you to enter register functions and start deliveries. |
| Stop/Cancel Key | Allows you to stop a delivery and cancel an operation. |
| Arrow Keys | Allow you to move to different fields on the Register. |

Navigation Keyboard Functions (Continued)

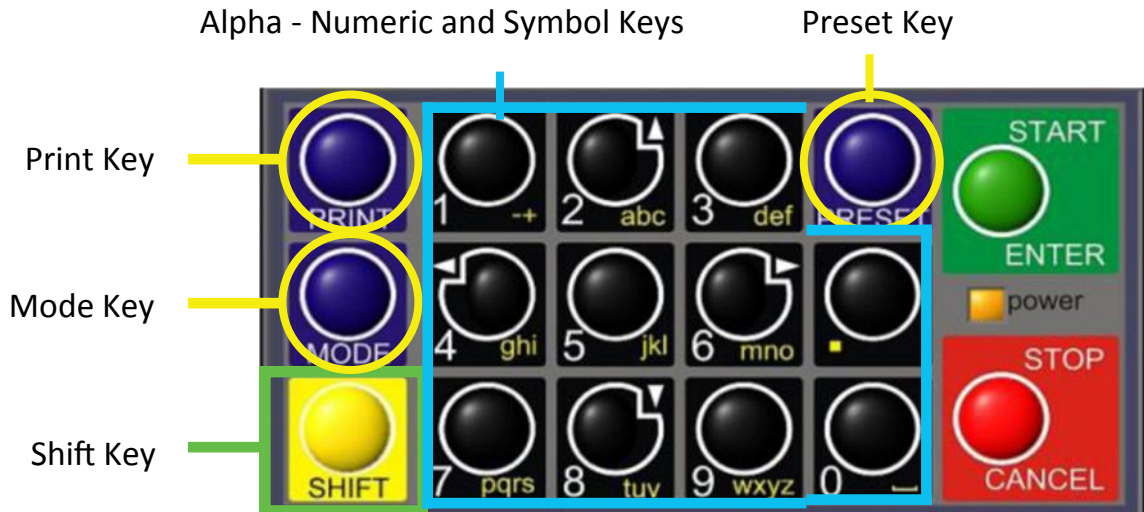

- Preset Key** Allows you to PRESET the Price and Tax as well as Gallons into the Register.
- Alpha - Numeric Keys** Allow you to enter different prices, products, etc. into the Register.
- PERIOD** Hold Shift key while pressing Period key for symbols: ., %, @, &, (,), /, #, - and _.
- Mode Key** MODE allows you to select different screens on the Register.
- Print Key** Allows you to print. You can print the delivery with or without selecting the STOP key.
- Shift Key** Allows you to select the Alpha Keys on the Alpha/Numeric Keys. Selecting Shift allows you to use anything on the Key Pad in yellow.
- Shift & Mode** Allows you to get into the main Menu screen.

Display Icons

ICON	DESCRIPTION
	Printer with no ticket.
	No printer connection
	Printer ready with Ticket
	Valve not open
	Valve(s) open
	Multiple Tank Delivery
	System Settings
	Weights & Measures
AIR	Air/Vapor Exhaust

SELECT FUNCTION MENU

Start Delivery	Begins delivery transaction.
Show Last Delivery	Shows the last delivery on the TCS 3000 screen.
Begin or End Shift	Beginning Shift will take a record of Delivery information at the start through the end of the user shift.
View Inventory	Shows the inventory in the tank.
Duplicate Shift Ticket	Duplicate Shift Ticket will print a duplicate of the Begin or End Shift.
Re-Print Tickets	Will reprint past delivery transactions
Non-Printed Delivery	Prints the last 75 transactions that have not printed.
Already Printed Delivery	Reprints the last #### of transactions already printed
Shift Tickets	Reprints the last #### of shift tickets.
System Menu	Setup and Configuration MENU'S for TCS 3000
Reports	Calibration Log / Identification and Software Version
System Settings	Configuration of System Parameters, Printer and Auxiliary Devices
W&M Settings	Product Setup and Calibration
Product Settings	Product Activation, Price Settings, Device Time Settings & Auxiliary Settings
Advanced Functions	System Software Update

Start Delivery

- 1) **START DELIVERY.** Press **START** to begin delivery transaction. This will reset the register causing the delivery screen to read 0.0. Start your delivery.
- 2) If a Preset or Customer ID Field is Enabled, the delivery process will begin with prompts requesting data input. See Page 14 for Preset Settings and / or for Customer ID Field to Enable/Disable.
- 3) If a Multiple Tank Delivery is Enabled, the Operating Driver must Hold the **SHIFT** key down while pressing the **START** key. When the Multiple Tank Delivery begins, a multiple tank icon will be displayed during delivery. See Page 14 for Multiple Tank Delivery to Enable/Disable.
- 4) **Finish the delivery.** Press **STOP** once to finish delivery. Or, press **STOP** once to **PAUSE** and twice to **STOP**, if Delivery Pause is enabled. If the Printer is Enabled, the ticket will be printed automatically. If the printer is not Enabled, it will be stored in memory to be retrieved at a later date.



Show Last

SHOW LAST Press START/ENTER to see the last delivery transaction

Begin Shift/End Shift

The Shift function records the Time/Date, Meter Identification and the Delivery Data from the beginning of the shift to the end of the shift. NOTE: This function is only accurate as the driver operators that utilize this feature.

- 1) BEGIN SHIFT Press and hold the SHIFT key, then press the MODE key.
- 2) END SHIFT Press and hold the SHIFT key, then press the MODE key.

After or before each Shift, the display will read Saving and Printing BEGIN or END Shift Ticket.

Sample Begin and End Shift Tickets

Total Controls Systems 2515 Charleston Place Fort Wayne, IN 46808 Voice (800) 348-4753 Fax (260) 484-9230	
=====	
BEGIN SHIFT TICKET	
=====	
Driver	: Kelly, Bob
Start	: 09/29/10 20:54:10
Unit	: 3
First Ticket	: 5
Gross Start Total	: 8.0

Starting Inventory :	
Fuel Oil	2000.0
Gasoline	2000.0
Diesel	654.9
=====	
Driver Signature	

Total Controls Systems 2515 Charleston Place Fort Wayne, IN 46808 Voice (800) 348-4753 Fax (260) 484-9230	
=====	
END SHIFT TICKET	
=====	
Driver	: Kelly, Bob
Start	: 09/29/10 20:54:10
End	: 09/29/10 20:54:32
Unit	: 3
Deliveries	: 0

Total Sales	: 0.00

Gross Start Total	: 8.0
Gross End Total	: 8.0
Gross Shift Del	: 0.0

Ending Inventory :	
Fuel Oil	2000.0
Gasoline	2000.0
Diesel	654.9
=====	
Driver Signature	

View Inventory

View Inventory allows you to select and view the inventory of product in the tank.

INVENTORY DISPLAY Displays the inventory and tank size.

SELECT INVENTORY Allows you to use the arrow keys to select the product in order to view the Inventory Details.

PRINT INVENTORY REPORT Generates a ticket of the Inventory Report

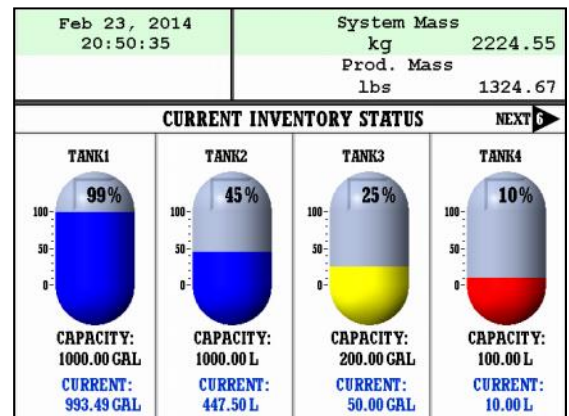

Duplicate Shift Ticket

To print a Duplicate Shift Ticket, navigate down to select the function and press ENTER.

Re-Print Tickets

To locate and reprint a past delivery ticket, navigate down to select the function and press ENTER

- | | |
|-----------------------------|--|
| 1) NON PRINTED DELIVERY | Will ask how many of the last sequential tickets (that have NOT printed) do you wish to print. Enter quantity and press ENTER. |
| 2) ALREADY PRINTED DELIVERY | Will ask how many of the last sequential tickets do you wish to re-print. Enter quantity and press ENTER. |
| 3) NON PRINTED INVENTORY | Will ask how many of the last sequential inventory tickets (that have NOT printed) you wish to print.
Enter quantity and press ENTER. |
| 4) PRINTED INVENTORY | Will ask how many of the last sequential inventory tickets you wish to re-print.
Enter quantity and press ENTER. |
| 5) SHIFT TICKETS | Will ask how many of the last sequential tickets do you wish to re-print. Enter quantity and press ENTER. |

System Menu (Quick Guide)

Reports

Operation Parameters	View and print calibration, meter information and software
Show Prover Status	View existing voltages, temperatures and runtimes
Prover Ticket	Weights & Measures access, calibration and configuration log
Meter Info	Print the last calibration proving ticket
Version Info	Meter identification
Memory Status	Operating Firmware and Software
Print Error Log	View stored delivery, inventory, calibration and transferred (TCS HUB) tickets
Checksums	Print error logs from register
Preview Prover Ticket	View checksums from software, firmware and operating system
Preview Error Log	View Prover Ticket without a printer
	View error logs from register with a printer

System Settings

Display Settings	Configuration of system functions
Printer Settings	Configure display screens and fields
Regional Settings	Select printer, host ,remote or none
Delivery Settings	Date and Time settings
Auxiliary Devices	Configure delivery functions like tickets, presets, ID fields, etc.
Connectivity	Select and configure auxiliary devices and pulse output
Misc. Settings	Configure register and printer addresses for network data sharing
	Password and Database settings

W&M Settings

Products	Weights & Measures product setup and calibration
Accounting	Product settings and calibration
Delivery Screens	Set ticket number, configure delivery tickets
System Metrics	Configure delivery screen fields for display
Temp Probe	Unit of measure precision
Meter Information	Temperature probe calibration
Prover Ticket	Register, Meter and Truck Identification
Tickets Cleanup	Print calibration proving ticket
Reset Totalizers	Allows you to delete the oldest 500 printed tickets over 5000 transactions
Enable Remote Config	Reset system and product totalizers
Pulser Tracker	Remote interface configuration

Product Settings

Inventory	Product identification for shifts and price/tax
Product Prices	Create or remove tank inventories; as well as assigning products to these tanks
Activate Product	Product pricing and taxation
Deactivate Product	Activating onboard products within Shifts
Product Parameters	Deactivating onboard products outside of Shifts
Auxiliary Settings	Product preset and auxiliary device timing
Product Lists	Auxiliary device configuration for a Additive Injector, Pressure Sensor, etc.
	Listing of active, inactive and uncalibrated products

Advanced Functions

System Shutdown	Administrative Configuration
System Update	Rebooting of system
	Software update

Reports

1) OPERATION PARAMETERS

Selecting Operation Parameters allows you to view the live Battery and 5V Supply Voltage to internal components, as well as Display, Main Board and RTD temperatures. The Runtime is the accumulated time of the register operation from the factory.

2) SHOW PROVER STATUS

Selecting Show Prover Status allows you to view the last date and time of the last calibration.

3) PROVER TICKET

Selecting Prover Ticket allows you to print the prover information from the register.

4) METER INFO

Selecting Meter Information allows you to view the Meter Data, such as The Truck ID, Register ID, Meter Make, Meter Model, Meter Version, and the Meter Serial Number. Information must be input within the Weights & Measures menu. +++ *Required for Calibration Prover Ticket* +++

5) VERSION INFO

Selecting Version Info allows you to view the Version of Software and Firmware running on the TCS 3000.

6) MEMORY STATUS

Selecting Memory Status allows you to view the number and type of tickets printed by the TCS3000. The Transferred and Non-Transferred deliveries show whether the delivery information has been seen and transferred to third party software accounting POS programs.

7) PRINT ERROR LOG

Selecting Print Error Log allows you to log printer errors in e-ticket. To view the print errors you must have a computer interface (e.g. handheld device, HUB, etc.).

8) CHECKSUMS

Selecting Check Sums allows you to check the TCS 3000 software for errors.

-Software Checksum

-Firmware Checksum

- OS Checksum

Jun 10, 2015 14:24:21	System Gross GAL 21.8
SOFTWARE CHECKSUM	
REFERENCE SOFTWARE CHECKSUM: 4BC82E5349011B7C9498FEB311A09792	
CURRENT SOFTWARE CHECKSUM: 4BC82E5349011B7C9498FEB311A09792	
PRESS "MODE" TO-RECALCULATE PRESS "CANCEL" TO EXIT	

The Reference and Value must match.

If the values do not match, select mode to recalculate the value.

9) PREVIEW PROVER TICKET

Selecting the Preview Prover Ticket will allow you to scroll page by page through the calibration prover ticket.

10) PREVIEW ERROR LOG

Selecting the Preview Error Log will allow you to scroll through the error log of the TCS 3000 computer.

System Settings

1) DISPLAY SETTINGS

DEFAULT SCREEN

Select the Type of Screen you would like the TCS 3000 to default to.



TYPE 1



TYPE 2

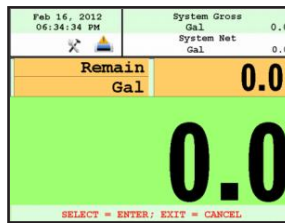

TYPE 3



TYPE 4

* TYPE 4 Only displays delivered volume.

CALIBRATION SCREEN

Temperature
Flowrate
Empty

Calibration screen will show volume/mass and Temperature
Calibration screen will show volume/mass and Flowrate
Calibration screen will show volume/mass and nothing else

BRIGHTNESS

Brightness allows you to set the brightness of the display screen from 100 to 30 percent (brightest to dimmest) settings.

NET TOTALIZER

Net Totalizer allows you to set whether the Net Totalizer is visible on the display screen.

Always
Auto
Never

Net Totalizer is always visible
Net Totalizer is visible only when a product has Automatic Temperature Correction (ATC) enabled on a Product
Net Totalizer is never visible

GROSS TOTALIZER

Gross Totalizer allows you to set whether the Gross or Volume Totalizer is visible on the display screen.

Volume Totalizer
Mass Totalizer

Volume Totalizer is always visible
Mass Totalizer is always visible

2) PRINTER SETTINGS

ENABLE/DISABLE PRINTER

Enable
Disable

Allows the printer to operate. Highlight Enable and select ENTER. When the printer is Enabled, a printer icon will appear in the top left portion of the screen.
Will not allow the printer to operate. Highlight Disable and select ENTER. When the printer is Disabled, the little printer will disappear in the top left portion of the screen.

SELECT PRINTER

None	No printer is to be used, will remove the communication for printing.
Remote	Client Registers must select Remote to allow you to use a printer remotely when connected to the register through a daisy chain RS485 serial communication.
Epson TMU 220/295	Epson slip or roll printer driver installed
Citizen CMP30	Citizen printer driver installed
Printek	Printek printer driver installed
DDP-350	Stimare printer driver installed
Blaster	Blaster printer driver installed
Blaster_DLXI	Blaster printer driver installed
Blaster_CR	Blaster printer driver installed

PRINTER HOST

Printer Host is used when you plan to daisy chain multiple TCS 3000 registers together for a single printer. Host is the primary meter and the Clients are all registers following the Host. Client registers must select the Remote printer.

Enable/Disable Host	To Enable or Disable the Printer Host, highlight Enable or Disable and select ENTER - Enable will allow you to use Printer Host - Disable will not allow you to use Printer Host
---------------------	--

Clients Address Range Use the keypad to define the starting and ending address range of registers on the daisy chain (See pages 34-35 for instructions on how to daisy chain).

3) REGIONAL SETTINGS

DATE & TIME

Date Format	MMMM DD, yyyy MM/dd/yyyy yy/MM/dd dd/mm/yyyy dd/mm/yy
Time Format	24 Hour Clock 12 Hour Clock AM/PM
Set Date	Year — Format YYYY Month — Select Month Date — Select Date
Set Time	Format time: Hours.Minutes.Seconds (HH.MM.SS) NOTE: Hours - 24 hr. clock and a period must be used as your divider
Time Source	BIOS source time and date Controller source time and date

DECIMAL SYMBOL Select a '.' period or a ',' comma and press ENTER

4) DELIVERY SETTINGS

PRESET SETTINGS

Enable Preset Utilizing the preset will request a preset amount before a delivery begins. After selection, press ENTER to complete setting.

Enable Preset	Enable or disable preset
Preset By Price	Enable or disable preset by Price
Gross Preset	Enable or disable preset in GROSS VOLUME
Net Preset	Enable or disable preset in NET CORRECTED VOLUME
Retain Preset	Enable or disable preset for repeat BATCH presets
Preset Top Off	Enable for preset batch and Pause. Press START to continue delivery.

NOTE: Each Preset Setting requires configuration under Product Settings for S1 and S2 operation. (See page 19 for instructions on how to configure Preset valve closure).

MULTIPLE DELIVERIES

Allows for the user to fill multiple tanks on one (1) single ticket transaction. Simply press and hold the SHIFT key down while pressing the START key to begin the multiple deliveries. If preset is enabled, each tank delivery will prompt the preset amount.

CUSTOMER ID OPTIONS

The Customer ID Option will provide four (4) separate fields for the user to input prior to the delivery. The Customer Identification is normally used for Tank, Truck, Airplane Tail No., Locomotive, Driver, Customer, etc. Manual entry of data will be required through the alpha-numeric keypad. After selection, press ENTER to complete setting.

Customer ID# (1-4)

Customer ID# Text

Field programmable for identification

Request ID#

Field prompts user to enter an ID

Enforce ID#

Field requires user to enter an ID in order to operate the system

Validate ID#

Field validates the ID to ensure the ID is in the database, if invalid the system will be inoperable

DISPLAY PRECISION

The unit precision can be displayed as a whole, tenth, hundredth or thousands measurement. After selection, press ENTER to complete setting.

1	Whole Unit
1.1	Tenth Unit
1.11	Hundredth Unit
1.111	Thousands Unit

ZERO FLOW TIMEOUT

Feature will complete a delivery transaction if the user does not press the STOP key. Enter number value in Seconds for the timeout setting and press ENTER.

NOTE: Factory setting is 180 seconds, 3 minutes after the last pulse transmission to the TCS 3000 register. This feature CANNOT be disabled. For desired extended periods, utilize a large number to have the Timeout ignored (Example: 99999).

PAUSE OPTIONS

Pause controls how pump control is used.

Allow Pause Allow Pause will Pause the pump during the delivery

Pause Pump Pause Pump will stop the pump during a Paused delivery.

5) AUXILIARY DEVICES

EXTERNAL DISPLAY

The External Display setting is for the specific manufacturers of large LED displays. This setting is for serial communication to an ancillary display that will read the same data that is displayed on the TCS 3000 register.

Enable/Disable Enable or disable and press ENTER

Configure Select Type: Red Lion LD, Omega & Tekinno displays are currently the only external displays supported today
 Address: Display Address from 1 to 99 and press ENTER
 Display Data Choose the information to display on External Display and press ENTER
 - Delivery Gross
 - Delivery Net
 - Delivery Volume
 - Delivery Total (Currency)
 - Flow Rate
 - Mass

Test This is a test sequence of numbers to exhibit on external display

AIR ELIMINATOR

The Air Eliminator is for the electronic actuation of a solenoid exhaust vent and a down stream valve, when a level sensor switches.

AE Enable/Disable Enable or disable for operation
 AE Detection Select Normally Open or Closed for level sensor detection
 AE Relay Enable or disable exhaust vent solenoid valve actuation

PULSE OUTPUT

The solid state pulse frequency transmission of a scalable pulse factor
 ++ May require a 1K ohm pull down resistor to bring pulse to ground (0Vdc) ++

Enable/Disable Enable or disable operation

Configure Sets the DEFAULT for pulse transmission output data

 Delivery Total (Currency)

 Gross Volume

 1 (1 pulse per unit)
 1.1 (10 pulses per unit)
 1.11 (100 pulses per unit)
 1.111 (1000 pulses per unit)

 Net/Gross Auto Detect Volume

 1 (1 pulse per unit)
 1.1 (10 pulses per unit)
 1.11 (100 pulses per unit)
 1.111 (1000 pulses per unit)

 Pulse Repeater repeats the incoming pulse value

Startup Reset Enable or disable and press ENTER

RFID READER

Radio Frequency Identification (RFID) is for fixed location or fleet refueling.
 ++ requires the a database uploaded to the TCS 3000 register for this option to be used ++

External External is used for remote mobile readers
 ThingMagic ThingMagic is for fixed reader locations

ANALOG INPUT

Analog Input is for the 4-20 mA Boards used with the Differential Pressure & Tank Level Gauges

None Nothing is selected.

X1 Channel Single channel only allows you to use 1 device with the TCS 3000 (1 Differential Pressure or Level Gauge).
Must choose the input:
 - Voltage (5 Vdc Capacity)
 - Current (4 - 20 mA)

NOTE: The single channel analog communication board is mounted within the TCS 3000 register. This should be ordered from the factory, but can be mounted after market.

X8 Channel Eight channel allows you to use 8 devices with the TCS 3000 for Level and Pressure
 - Level Meters (1 - 6)
 - Voltage (5 Vdc Capacity)
 - Current (4 - 20 mA)
 - Pressure (7 - 8)
 - Voltage (5 Vdc Capacity)
 - Current (4 - 20 mA)

NOTE: Externally mounted from the TCS 3000 register in a NEMA 4X enclosure.

LEVEL METERS

Allows you to select the curve on the level meter.

Linearization Type

External (0-100%) - Tank capacity percentage to volume level.

Quasi Linear - Currently Not Available

Polynomial - Currently Not Available

Calibration

View/Edit - Allows you to enter the percentage of product in the tank.

(% equivalent to tank volume, the more points entered the greater the accuracy)

New Calibration - Automatically senses the tank level, READ the instructions on the TCS 3000 Screen before you begin.

PRESSURE SENSORS

Allows you to program the maximum and minimum pressure of the vessel. If the pressure is too low or too high the systems will shutdown.

View/Edit 1) Minimum Pressure Input
 2) Minimum Output Current mA or Voltage Entry
 3) Maximum Pressure Input
 4) Maximum Output Current mA or Voltage Entry

NOTE: Settings will be based on whether Current (mA) or Voltage was selected under Analog Input Settings

Unit Choose the Unite of Measure: PSI, BAR, Pa, kPa, mPa, kg/cm2

6) CONNECTIVITY

Connectivity is used for accessory communication settings

Network Settings

Interface Bridge Interface is for handheld communication. An interface is required for this setting. You must Enable or Disable the Interface Bridge accordingly.

Address Device Address will assign the TCS 3000 the unique address within the Daisy Chain communication sequence. It is recommended to assign addresses as follows:

- Primary Host will always be number one (1)
- Client Address range will be programmed from two (2) through eight (8).

NOTE: Client Address range can reach as many as one hundred and twenty seven (127), however this will slow the processor down. Eight is recommended number of registers in the daisy chain.

Printer Settings

Enable/Disable	Enable or Disable for operation
Select Printer	Select desired printer to be used with the system
Printer Host	Enable or Disable a printer host
	Clients Address Range Displays the range between Client Address range.

7) CONFIGURE TICKET HEADERS/FOOTERS

DLV Header Defaults	There are FIVE programmable fields for contact information or messages
DLV Footer Defaults	There are FIVE programmable fields for contact information or messages
Shift Tickets Headers	There are FIVE programmable fields for contact information or messages
Inventory Tickets Headers	There are FOUR programmable fields for contact information or messages
Prover Tickets Headers	There are FOUR programmable fields for contact information or messages

8) MISC SETTINGS

L1 Password Level one (1) password protection for System Settings.

Procedure to set L1 Password is as follows:

1. Highlight L1 Password and press ENTER.
2. Highlight Set Password and press ENTER.
3. Input alphanumeric password and press ENTER.
4. Confirm password entry by resubmitting password, and press ENTER.

NOTE: Alphanumeric password must be at least three (3) characters long.

L2 Password Level two (2) password protection for User ID Management

Procedure to set L2 Password is as follows:

1. Highlight L2 Password and press ENTER.
2. Highlight Set Password and press ENTER.
3. Input alphanumeric password and press ENTER.
4. Confirm password entry by resubmitting password, and press ENTER.

NOTE: Alphanumeric password must be at least three (3) characters long.

Access Key Access Key is used to lock or unlock the register keyboard when a Computer or Handheld device is in use. Register (USB0 and USB1).

System Mode System Mode is used for databases (CONTINUED ON NEXT PAGE)

Default
MR1

Used for standard register mode
Used for database

User DB Update

Used to update the database. A portable USB memory drive loaded only with a factory database file must be uploaded through the mini-USB adapter located within the Register (USB0 and USB1).

Weights & Measures Settings

NOTE: The Calibration bolt must be removed in order to enter calibration mode. To remove the bolt, unscrew the bolt with a 3mm Hex drive. Place calibration plate and screw in a safe location where it will not be lost. Under the calibration plate you will find a screw. Using the 3mm Hex drive, loosen the calibration screw. You do not need to remove this screw all the way.

If you lose the calibration screw, you will not be able to operate the register.

DO NOT LOSE THIS CALIBRATION SCREW

BEFORE YOU CALIBRATE THE REGISTER YOU MUST ENTER A PRODUCT
To Calibrate begin in section ADD NEW on Page 22.

***NOTE: ALL PRODUCTS MUST BE CALIBRATED INDIVIDUALLY ***

PRODUCTS

RECALIBRATE PRODUCT

SELECT PRODUCT Highlight the product you want to re-calibrate and select ENTER.

NOTE: If you need to modify the settings you originally selected for the calibration of a product select MODIFY PARAMETERS, if the settings were correct and you do not need to change them select BEGIN RECALIBRATION.

A) Modify Parameters

Product Name Using the keypad type in the name of the product you are calibrating. If the product listed is correct select ENTER. To change the product name press Enter and input name as desired. The menu screen will provide instructions on how to input your Alpha-Numeric keys.

Compensation Table Choose the correct Volume Temperature Compensation Table and press ENTER. See TABLE 2 for reference.

Comp. Table Param. Input the correct Compensation Table Parameter and press ENTER. See following tables for reference. NOTE: this list references most common products, not an exhaustive list of every volume correction

Product Name	API Table	Temp.	Coefficient Value	Range
Fuel Oil	6B	F	API Gravity	32 - 35
Gasoline	6B	F	API Gravity	62 - 65.1
Premium Gasoline	6B	F	API Gravity	59.1
Diesel	6B	F	API Gravity	32 - 35
Kerosene	6B	F	API Gravity	42
Jet A	6B	F	API Gravity	41.9 - 42.9
Jet A-1	6B	F	API Gravity	41.9 - 42.9
Av Gas	6B	F	API Gravity	42 - 44
Refined Fuels	6B	F	API Gravity	0 - 85

Product Name	API Table	Temp.	Coefficient Value	Range	Mean
Liquefied Propane Gas (LPG)	24	F	Specific Gravity	0.500 - 0.550	0.510
Liquefied Propane Gas (LPG)	54	C	Density KG/L	0.500 - 0.600	0.510
Gasoline	54B	C	Density KG/m3	640 - 780	730
Diesel Oil	54B	C	Density KG/m3	780 - 1074	840
Fuel Oil	54B	C	Density KG/m3	830 - 900	840
Kerosene / Jet Fuel	54B	C	Density KG/m3	780 - 840	800
Stoddard Solvent	54B	C	Density KG/m3	780 - 800	790
Lubricating Oils	54B	C	Density KG/m3	850 - 905	880

Mass Density

To provide a calculated Mass value, determine the value to input Mass Density and press ENTER.

Mass = Weight per Volume

Unit of Measure	
Gram/cm3	Gram/Cubic Centimeter
Gram/m3	Gram/Cubic Meter
Kilogram/m3	Kilogram/Cubic Meter
Milligram/m3	Milligram/Cubic Meter
Pound/ft3	Pound/Cubic Foot
Pound/in3	Pound/Cubic Inch
Ton/yard3	Ton/Cubic Yard

Pump Control & Timing

Enable/Disable Pump Control and select ENTER.

- Pump is an Optional Output Control
- Enabled means that the pump control will energize a PTO or Hydraulic Drive during a truck delivery.
- Disabled means that the pump control is not active and will not energize.

Pump Speed Control 1 is a solid state voltage output signal based on a flow rate setting. Flow rate setting of zero (0) is disabled. Utilizes the Pump Starter terminal. *NOTE: Pump Speed Control overwrites the Additive Pump setting.*

Pump Speed Control 2 is a solid state voltage output signal based on a flow rate setting. Utilizes the Reset terminal. Flow rate setting of zero (0) is disabled.

Pump Starter to enter the Start Duration time in seconds for pump to energize while the preset valves (S1 & S2) stay closed, then press ENTER.

Pump Starter Advance is Not available at this time.

Pump Stabilization is used to enter how long you wish the Pump Starter stays powered. Enter value in Seconds and press ENTER.

Valve Type

Select whether you are using a Single or Dual Stage Valve and press ENTER.

- A SINGLE Stage valve will energize valve with Solenoid 2.
- A DUAL Stage valve will energize valve with Solenoids 1 and 2.

1101 Both S1 and S2 energize at the beginning of delivery and near the end of the delivery S1 shuts off and S2 is still operating.

1001 At the beginning of the delivery the S1 valve opens energizes while the S2 remains closed. When the preset slow flow bypass begins, the S1 valve closes and the slow flow bypass valve S2 opens until the end of the delivery.

S1 - S2 Delay

Timing of the S1 valve opening at the start of a delivery. Enter S1 time value (minimum of 3 seconds).

Maximum Flowrate

Input the maximum rated flow of flow meter and press ENTER.

NOTE: this value is critical to the Valve actuation!

S2 Flow

Timing of the S2 valve closure rate. Enter S2 time value (minimum 0.3 seconds).

Pulser Type

Select the pulse input type (Single or Dual Channel) and press ENTER.

SINGLE is a single channel pulse input (i.e. Magnetic, Turbine & Coriolis Flow Meters).

DUAL is a dual channel pulse input

QUAD is a dual channel pulse input multiplied by two.

Pulser Estimate

Manual entry of the Meter Pulse Estimate (Meter Factor). Input pulse value and press ENTER.

NOTE: The TCS 3000 register will not accept the entered Pulse Estimate until a physical calibration is placed immediately after entry. See Edit Product Calibration on page 21 for direct entry and acceptance.

Product Units

Select TCS 3000 register units of measure and press ENTER.

Volume: Highlight Volume Unit and press ENTER.

GAL	USA Gallons
L	Liters
UKG	UK Gallons
daL	Dekaliter
mL	Milliliter
m3	Cubic Meter
bbL	Barrel

NOTE: Selecting Product Unit does not change the Totalizer unit of measure. See Page 26 for changing Totalizer unit of measure.

Hose Volume

Enter unit volume value for "packing" hose downstream of meter and press ENTER. Value will not display prior to setting and there will be no lost liquid. See Page 22 for Enabling this function.

To comply with Weights & Measures requirements, it is necessary to start and stop each delivery with a fully packed hose. There are times where the hose is not fully packed (e.g. after a preset delivery). As such, the hose must be packed and the register zeroed prior to making the next deliver.

NOTE: This procedure will not work for an empty or dry hose. If more than 1 gallon or 5 Liters of liquid is required to pack the hose, a delivery ticket must be printed.

Maximum Pulser Error Program the amount of reverse pulse counts the register is allowed to see before it shuts the system down. NOTE: Maximum value is 255.

Additive Injector

Injection Ratio How many parts per million will be injected into the product.

Injector Type None No Injector

External A constant positive signal output is provided during product delivery.
NOTE: Additive Injector controls injection pump rate.

Edit/View Parameters - Manually Calibrate the Additive Injector

AI Pulses/Unit (Enter Pulses per mL)

AI Pulser Type - Dual or Single

Injection Limits - Enable/Disable Additive Injection Limit for delivery shutdown.

Enter Minimum PPM value to end delivery

Enter Maximum PPM value to end delivery

Enter Additive Injection Stabilization Volume to stabilize the PPM ratio at the beginning of a delivery.

EXAMPLE: GTP Viper Injector pump will dose every 5 Gallons.

Without an additive injection dose within the first 5 gallons, the minimum PPM threshold will stop the delivery).

Piston A pulsing positive signal output is provided during product delivery.

Injection Ratio - Enter desired Parts Per Million volume.

Injection Limits - Enable/Disable Additive Injection Limit for delivery shutdown.

Enter Minimum PPM value to end delivery

Enter Maximum PPM value to end delivery

Enter Additive Injection Stabilization Volume to stabilize the PPM ratio at the beginning of a delivery.

Injector Calibration

Calibrate - Automatically Calibrates the Additive Injector Pump

1) Begin calibration by pressing Enter

2) Enter volume on volumetric beaker.

Edit/View Parameters - Manually Calibrate the Additive Injector

AI Pulses/Unit (Enter Pulses per mL)

AI Pulser Type - Dual or Single

AI Min. Inj. Period - Time required for injection (mS)

NOTE: Requires external cable harness to perform calibration. If no cable harness is used, all Calibration Test Runs must be run outside of W&M Settings.

Injection Limits Enable/Disable Additive Injection Limit threshold for delivery shutdown.

Enter Minimum PPM value for shutdown

Enter Maximum PPM value for shutdown

Enter Additive Injection Stabilization Volume, used to stabilize the PPM ratio at the beginning of a delivery.

Injection Calibration Calibrate - Automatically Calibrates the Additive Injector Pump

1) Begin calibration by pressing Enter

2) Enter volume on volumetric beaker.

Edit/View Parameters - Manually Calibrate the Additive Injector

AI Pulses/Unit (Enter Pulses per mL)

AI Pulser Type - Dual or Single

AI Min. Inj. Period - Time required for injection (mS)

B) Begin Recalibration

***NOTE: ALL PRODUCTS MUST BE CALIBRATED INDIVIDUALLY ***

FULL CALIBRATION: Select Full Calibration to clear old calibration value(s) and establish a new calibration point for Product.

- 1) The display will prompt you to press START to begin automatic calibration of the flow meter. Press STOP when finished with a certified Weights & Measures volumetric or gravimetric proving system.
- 2) Input Prover Value and press ENTER. A Calibration Summary screen will appear with the Gross Amount, Net Amount, Average Temperature, Compensation Table, Pulse/Second and *Pulse/Volume (Meter Calibration Value)*.
- 3) Press START to Accept calibration value.
- 4) The display will ask if you would like to store this point. Enter to Store the calibration value or press Mode to run calibration over again.

NOTE: failure to Store the calibration value will lose the calibration data and require you to run the FULL CALIBRATION over again.

ADD POINT: Select Add Point to create a Multi-Point Calibration curve over the entire flow range of the flow meter. The minimum points required are two (2) and one hundred (100) is your maximum points accepted.

- 1) Select Add Point to add an addition point at a specific flow rate to linearize your calibration curve from minimum to maximum flow rates.
- 2) The display will prompt you to press START to begin automatic calibration of the flow meter. Press STOP when finished with a certified Weights & Measures volumetric or gravimetric proving system.
- 3) Input Prover Value and press ENTER. A Calibration Summary screen will appear with the Gross Amount, Net Amount, Average Temperature, Compensation Table, Pulse/Second and *Pulse/Volume (Meter Calibration Value)*.
- 4) Press START to Accept calibration value.
- 5) The display will ask if you would like to store this point. Enter to Store the calibration value or press Mode to run calibration over again.

NOTE: failure to Store the calibration value will lose the calibration data and require you to run the ADD POINT over again.

C) Edit Prod. Calibration

Allows a manual calibration modification of each flow rate point. A "WARNING" screen will then be displayed, press ENTER to continue to change Meter Calibration Value.

- Select Product to manually change Meter Calibration Value. Select Calibration Point to adjust the current Meter Calibration Value by multiplying by the equation below.

- Input value and press ENTER, which will display a "MODIFICATION" screen. Press any key to continue.

- Always double check to make sure the product calibration value was changed correctly.

$$\% \text{ ERROR} = \frac{\text{Volume on Meter Display} - \text{Volume on Prover}}{\text{Volume on Prover}} \times 100$$

Total Control Systems - Meter Pulse Value Factors

FLOW METER	PULSE CHANNEL	TCS 3000 75/90 DEGREE MOUNT				Direct Mount Pulsar 100:1 TCS 3000 REMOTE MOUNT	
		682-15	Single	200.0 Pulses/USG	52.85 Pulses/LTR	400.0 Pulses/USG	105.7 Pulses/LTR
	Dual	400.0 Pulses/USG	105.7 Pulses/LTR	800.0 Pulses/USG	211.4 Pulses/LTR		
	Quadrature	800.0 Pulses/USG	422.8 Pulses/LTR	1600.0 Pulses/USG	422.8 Pulses/LTR		
FLOW METER	PULSE CHANNEL	4:1 Packing Gland (Standard) TCS 3000 75/90 DEGREE MOUNT				Direct Mount Pulsar 100:1 TCS 3000 REMOTE MOUNT	
		700-15	Single	305.9 Pulses/USG	80.8 Pulses/LTR	1223.7 Pulses/USG	323.3 Pulses/LTR
	Dual	611.6 Pulses/USG	161.6 Pulses/LTR	2446.4 Pulses/USG	646.3 Pulses/LTR		
	Quadrature	1223.2 Pulses/USG	323.4 Pulses/LTR	4892.8 Pulses/USG	1293.5 Pulses/LTR		
FLOW METER	PULSE CHANNEL	2:1 Packing Gland (Standard) TCS 3000 75/90 DEGREE MOUNT		1:1 Packing Gland TCS 3000 75/90 DEGREE MOUNT		Direct Mount Pulsar 100:1 TCS 3000 REMOTE MOUNT	
		700-20/25	Single	277.75 Pulses/USG	73.4 Pulses/LTR	555.5 Pulses/USG	146.8 Pulses/LTR
	Dual	555.5 Pulses/USG	146.8 Pulses/LTR	1111.0 Pulses/USG	293.6 Pulses/LTR	1111.0 Pulses/USG	293.6 Pulses/LTR
	Quadrature	1111.0 Pulses/USG	293.6 Pulses/LTR	2222.0 Pulses/USG	587.2 Pulses/LTR	2222.0 Pulses/USG	587.2 Pulses/LTR
700-30/35	Single	102.9 Pulses/USG	27.2 Pulses/LTR	205.8 Pulses/USG	54.4 Pulses/LTR	205.8 Pulses/USG	54.4 Pulses/LTR
	Dual	205.8 Pulses/USG	54.4 Pulses/LTR	411.6 Pulses/USG	108.8 Pulses/LTR	411.6 Pulses/USG	108.8 Pulses/LTR
	Quadrature	411.6 Pulses/USG	108.8 Pulses/LTR	823.2 Pulses/USG	217.6 Pulses/LTR	823.2 Pulses/USG	217.6 Pulses/LTR
700-40/45	Single	37.1 Pulses/USG	9.8 Pulses/LTR	74.2 Pulses/USG	19.6 Pulses/LTR	74.2 Pulses/USG	19.6 Pulses/LTR
	Dual	74.2 Pulses/USG	19.6 Pulses/LTR	148.4 Pulses/USG	39.2 Pulses/LTR	148.4 Pulses/USG	39.2 Pulses/LTR
	Quadrature	148.4 Pulses/USG	39.2 Pulses/LTR	296.8 Pulses/USG	78.4 Pulses/LTR	296.8 Pulses/USG	78.4 Pulses/LTR
700-60/65	Single	18.55 Pulses/USG	4.9 Pulses/LTR	37.1 Pulses/USG	9.8 Pulses/LTR	37.1 Pulses/USG	9.8 Pulses/LTR
	Dual	37.1 Pulses/USG	9.8 Pulses/LTR	74.2 Pulses/USG	19.6 Pulses/LTR	74.2 Pulses/USG	19.6 Pulses/LTR
	Quadrature	74.2 Pulses/USG	19.6 Pulses/LTR	148.4 Pulses/USG	39.2 Pulses/LTR	148.4 Pulses/USG	39.2 Pulses/LTR

D) Add New

Before you can calibrate the register, you must enter a product. Select Add New and use the keypad to enter a product (e.g. LPG, Fuel Oil, Aviation Gasoline, etc.). Once you've entered your product, press ENTER.

- All parameters for a New Product MUST be entered for the product to be accepted by the TCS 3000. Follow pages 17 through 19, under Modify Parameters to complete the Add New product setup. Once the new product parameters have been entered, you will be required to calibrate the product.

NOTE: A new product MUST be calibrated for it to be available as an Active product. Without calibration, the new product will only be seen in Product Settings LIST.

E) Remove Product

To remove an unwanted product from the TCS 3000, select and press ENTER. To confirm product removal, press MODE.

NOTE: You must first End Shift and then Deactivate the product under Product Settings.

F) Hose Charge

Enable or Disable the Hose Charge at beginning of delivery. Adjustment to the Hose Charge volume is made under the Product Hose Volume seen on page 19.

2) ACCOUNTING

Select Accounting to set the Ticket Number and Configure Tickets.

NEXT TICKET NO. Select Next Ticket No. to program the next delivery ticket number.

REQUIRE TICKET PRINT Select Require Ticket Print to require the user to print a ticket after every transaction.

CONFIGURE TICKETS

Select Ticket Type Sets the DEFAULT for the delivery ticket. If you create a new Ticket, you must choose the configured ticket as your default printed ticket. *NOTE: A MINIMUM ticket must be stored as a ticket type. Current pre-configured tickets are available to choose from the following:*

MAXIMUM	Allows the maximum amount of space on the ticket.
MINIMUM	Allows the minimum amount of space to be used on the ticket.

Customize Ticket Customize Ticket allows you to customize the preconfigured information printed on the delivery ticket. Choose from the following:

TCS 3000 Menu	Example Prints
Header 1	Total Control Systems
Header 2	TCS 3000
Header 3	Delivery Ticket
Header 4	(888) 888-8888
Header 5	Programmable Field
Thick Separator	-----
Start Time	Start Jun 04, 2012 09:42:09 AM
End Time	End Jun 04, 2012 09:53:42 AM
Truck ID	3842 - Meter 2
Ticket Number	#####
Product Name	Gasoline (Product setup in Prover)
ProdNet Total Begin	#####
ProdNet Totalizer	#####
ProdGrS Total Begin	#####
ProdGrS Totalizer	#####
SysNet Total Begin	#####
SysNet Totalizer	#####
SysGrS Total. Begin	#####
SysGrS Totalizer	#####
Delivery Section	-- Delivery --
Customer ID 1	Programmable Field
Customer ID 2	Programmable Field
Customer ID 3	Programmable Field
Customer ID 4	Programmable Field
Line	
Delivery Gross Begin	#####
Delivery Gross End	#####
Delivery Net Begin	#####
Delivery Net End	#####
TempComp Line	Volume Corrected to 60F (15C)
Tempcomp Table	Table -- i.e. Table 24
Average Temp	AVG Temp. F
Gross Delivered	Gross Gal. Delivered
Net Delivered	Net Gal. Delivered
Line	

CONFIGURE TICKETS CONTINUED...

Inventory Name	i. e. Tank 1 Diesel
Inventory Begin	#####
Inventory End	#####
Inventory	#####
Peak Corrected Differential Pressure (CDP)	i.e. 30 PSI
Average Corr. Diff. Pressure	i.e. 14 PSI
Average Flow Rate	i.e. 100 GPM
Peak Flow Rate	i.e. 130 GPM
Flow at Peak CDP	i.e. 130 GPM
Additive Volume	i.e. 200 mL
Additive Ratio	i.e. 1000 PPM
Calculated Mass	i.e. 830 lbs
System Mass Totalizer	#####
Product Mass Totalizer	#####
Unit Price	Unit Price --- i.e. 1.86
Sale Amount	#####
Tax 1	Tax 1 --- i.e. Road Tax
Tax 2	Tax 2 --- i.e. Sales Tax
Tax Amount	Tax Amount
Star Line	*****
Amount Due	Amount Due ----- ##.##
Empty Line	#####
Signature Line	<i>John C. Pella</i>
Thick Separator	-----
System Line 1	** Duplicate Invoice **
System Line 2	*** Power Loss ***
Footer 1	Programmable Field
Footer 2	Programmable Field
Footer 3	Programmable Field
Footer 4	Programmable Field
Footer 5	Programmable Field

- Add Ticket Type Create a NEW Customized Ticket, then press ENTER to name it.
Copy from an Existing Ticket, then press ENTER to name it.
NOTE: Any new ticket name must be 3 or more characters long
- Remove Ticket Type Select ticket to be removed from the system and press ENTER
- Header Defaults There are FIVE programmable fields for contact information or messages
- Footer Defaults There are FIVE programmable fields for contact information or messages
- Shift Ticket Headers There are FOUR programmable fields for contact information or messages
- Inventory Tickets Header There are FOUR programmable fields for contact information or messages

3) DELIVERY SCREENS

- Configure Type 1 Using the arrow keys to move Red Cursor around the screen, highlight the field you would like to change and select ENTER. The field options are in Table 1 below.
- Configure Type 2 Using the arrow keys to move Red Cursor around the screen, highlight the field you would like to change and select ENTER. The field options are in Table 1 below.
- Configure Type 3 Using the arrow keys to move Red Cursor around the screen, highlight the field you would like to change and select ENTER. The field options are in Table 1 below.
- Type 4 Not configurable by itself. Displays the large screen field option for Configuration Type 3.

TYPE 1

Feb 16, 2012 06:35:07 PM	System Gross Gal 0.0
	System Net Gal 0.0
TOTAL \$	0.00
PRODUCT	Volume
	0.0
SELECT = ENTER; EXIT = CANCEL	
Flowrate Gal/min 0.0	Volume Gal 0.0
Preset Gal 0.0	Remain Gal 0.0
Preset Amt \$ 0.00	Price \$/Gal 0.00
AVG Temp F 0.0	Temp F 0.0

TYPE 2

Jan 28, 2013 12:54:04 PM	System Gross Gal 0.0
Gross Gal 0.0	
PRODUCT	Volume
	0.0
SELECT = ENTER; EXIT = CANCEL	
Flowrate Gal/min 0.0	TOTAL \$ 0.00
AVG Temp F 0.0	Temp F 0.0

TYPE 3

Feb 16, 2012 06:34:34 PM	System Gross Gal 0.0
	System Net Gal 0.0
Remain Gal	0.0
	0.0
SELECT = ENTER; EXIT = CANCEL	

TYPE 4

Jan 30, 2014 05:35:51 PM	System Gross GAL 3575.0
Gross GAL	
1234	

DISPLAY FIELD SELECTION TABLE 1 OPTIONS:

Empty	No Data
Product Name	(LPG, Diesel, Av Gas, Etc.)
Delivery Gross	Non-Compensated Delivery Total
Delivery Net	Compensated Delivery Total
Delivery Volume	Amount of Delivery
Delivery Total	Total Price Delivered
Flowrate	Amount Delivered through Per Minute
AVG Temperature	Average Temperature of Product
Temperature	Temperature of Product
Mass	Mass of the Product (e.g. Pounds per Gallon, etc.)
Preset Remain	Remaining Preset (What is left of the Preset Total)
Preset Volume	Preset Volume Amount for Delivery
Preset Amount	Preset Currency Amount for Delivery
Density	Density of the Product
Comp. Table	Compensation Table (6B, 54B, Etc.)

DISPLAY FIELD SELECTION TABLE 1 OPTIONS (CONTINUED):

Unit Price	Unit Price
Calc. Price	Calculated Price
TAX1	Tax
TAX2	Tax
CORR. DP	Corrected DP (Correction for DP Gauge)
Peak CDP.	Maximum Correction of the DP Gauge
AVG. CDP	Average Correction of the DP Gauge
AVG FLOW	Average Flow Rate of the Register
PK. FLOW	The Highest Flow Rate of the Register Recorded
Massrate	Mass of the Product
Additive Volume	How much Product was injected during the Delivery (mL)
Additive Ratio	The Ratio of Additive to Product (mL)

4) SYSTEM METRICS

PRECISION The unit precision can be displayed as a whole, tenth, hundredth or thousands measurement. After selection, press ENTER to complete setting.

- 1 Whole Unit
- 1.1 Tenth Unit
- 1.11 Hundredth Unit
- 1.111 Thousands Unit

SYSTEM TOTALIZERS This function will allow display either a Volumetric or Mass Totalizer.

Select Volume or Mass and press ENTER. Then select the Unit of Measure.

VOLUME	
GAL	USA Gallons
L	Liters
UKG	UK Gallons
daL	Dekaliter
mL	Milliliter
m3	Cubic Meter
bbL	Barrel

MASS	
Lbs	Pounds
Oz	Ounces
t	Ton
Kg	Kilograms
g	Grams

5) TEMP PROBE

This function is used to change the reference temperature of the liquid meter system RTD temperature probe.

- ENBL DLV. W/O PROBE Enable or Disable deliveries without the RTD temperature probe. Enable to prevent Net Volume deliveries defaulting to Gross volume if the RTD temperature probe loses communication with the register.
- CALIBRATE TEMP PROBE Highlight Offset Calibration and press ENTER. Highlight Reference Temperature Unit of Measure and press ENTER.

TEMPERATURE	
C	Celsius
F	Fahrenheit
K	Kelvin

NOTE: Must use a metrological traceable temperature probe for calibration

6) METER INFORMATION

Selecting Meter Information allows you to enter the information off of your meter and register. This information is required for the Report Menu on page 10, as well as the Prover Tickets from Meter Calibration.

- REGISTER # Highlight Register # and input the TCS 3000 serial number located on the unit. Press ENTER when complete.
- TRUCK ID Highlight Truck ID to input the truck or tank number. Press ENTER when complete. NOTE: if there are multiple meters daisy chained together, the Truck ID and Meter sequence number should be input here (i.e. Truck 5381 Meter 2).
- METER VERSION Highlight Meter Version and enter the manufacture. Press ENTER when complete.
- METER MAKE Highlight Meter Make and enter the meter manufacturer's name and Press ENTER when complete.
- METER MODEL Highlight Meter Model and enter the assembly model number. Press ENTER when complete.
- METER SERIAL # Highlight Meter Serial # and input the meter serial number of the unit. Press ENTER when complete.
- SYSTEM ID Highlight System ID and input the system identification. Press ENTER when complete.

7) PROVER TICKET

Selecting Prover Ticket allows you to Print the existing Prover Data from the TCS 3000 register. Select PRINT to print the Prover Ticket.

8) TICKETS CLEANUP

Enabling Tickets Cleanup will allow the system to delete the oldest 500 non-printed tickets when there are more than 5000 non-printed tickets stored.

9) RESET TOTALIZERS

System and Product Totalizers record the amount of all liquid that has passed through the meter by product.

*** Please Note ***

**Resetting the Totalizers will reset the TCS 3000 Totalizers to zero.
There is no way to recover totalizers once deleted.**

SYSTEM TOTALIZER

System Totalizers record the amount of all liquid that has been measured. End Shift before resetting the System Totalizer. Highlight the System Totalizer and press ENTER. A "WARNING" will appear on the screen that you are about to reset the Totalizers. Press MODE to confirm the Totalizer reset.

PRODUCT TOTALIZER

Product Totalizers record the amount of liquid for a specific product that has been measured. You must End Shift (page 8) and Deactivate Product in Product Settings (page 31) before resetting the Product Totalizer. Without doing so, the error "No Active Products" will be displayed. Highlight Product Totalizer and press ENTER.

10) ENABLE REMOTE CONFIG

Allows you to connect the TCS 3000 to an External Handheld device to remotely control the Calibration of the register.

- To Enable Remote Config make sure your External Handheld is connected to the TCS 3000 register with the TCS 300859 quick disconnect cable kit).
- Highlight Remote Config and select ENTER. This will enable the Remote Config setting and you will be able to calibrate your system.
- **When finished calibrating, press any key to exit.**

11) PULSER TRACKER

Pulser Tracker tracks any flow between deliveries. Any time the pulser moves outside of a delivery the register captures the movement data.

++ If Pulser Tracker is disable, any product movement without hitting start will not be recorded in the totalizer. ++

Product Settings

1) INVENTORY

Inventory monitors how much product is in a tank.

VIEW INVENTORY Allows you to see your total inventory levels of numerous tanks on one display, See Individual inventory details, or print an Inventory Report.

**** Can be done during a Shift ****

UPDATE INVENTORY Allows you to correct the Inventory levels by manually entering the proper inventory level.

ADD TO INVENTORY Add to Inventory allows you to add to the current inventory when you are loading "X" amount of product to the tank

SET INVENTORY VALUE Set Inventory Value allows you to change the inventory level to a specific amount

FILL UP INVENTORY Filling up the inventory to 100% Tank Capacity.

EMPTY INVENTORY **QUICK RESET - Press SHIFT + PRINT**

Emptying the Inventory to 0%.

LEVEL METER Level Meter allows you to select the channel level meter being used.

++ Requires gauge to be calibrated, overriding the manual inventory entry ++

**** Can be done during a Shift ****

ASSIGN INVENTORY Allows you to Pair an Active Product or Products to the Inventory Tank Created to be Monitored.

****This must be done to track inventory levels****

****Can be done during a Shift****

ADD INVENTORY Creates an Inventory "Tank" to be monitored. Here you will Name your Inventory "Tank" Enter in the Tank Capacity and Enter the Current Tank Level

**** Must be outside of a Shift to do this step ****

REMOVE INVENTORY Removes the Inventory Tank from being Monitored

**** Must be outside of a Shift to do this step ****

Shortcut: Pressing Shift + Print will allow you to Update, Fill, or Empty Inventory Levels Quickly during a Shift

After Adjusting the inventory you will be prompted to provide a **Bill of Lading Number**

NOTE: After each calibration, you must reassign each product to its proper tank inventory.

2) PRODUCT PRICES

Product Prices allows the price to be set for a specific product. For multiple products, pricing must also be changed. To set pricing, highlight the desired product and press ENTER. NOTE: if you have not changed the Product name, the factory default "DEMO" may be displayed.

- UNIT PRICE** Highlight Unit Price and press ENTER. Input the price value and press ENTER.
- TAX 1 NAME** Highlight Tax 1 Name and press ENTER. Input tax name and press ENTER.
- TAX 1 TYPE** Highlight Tax 1 Type and press ENTER. Use the navigation arrows to select Tax 1 Type and press ENTER.
- TAX 1 VALUE** Highlight Tax 1 Value and press ENTER. Input tax value and press ENTER.

None	No tax will be entered.
Percent	Tax amount value is calculated as a percent (%).
Per unit	Tax is calculated per unit of measure.
TaxTax	Tax is calculated on a tax.

- TAX 2 NAME** Highlight Tax 2 Name and press ENTER. Input tax name and press ENTER.
- TAX 2 TYPE** Highlight Tax 2 Type and press ENTER. Use the navigation arrows to select Tax 2 Type and press ENTER.
- TAX 2 VALUE** Highlight Tax 2 Value and press ENTER. Input tax value and press ENTER.

None	No tax will be entered.
Percent	Tax amount value is calculated as a percent (%).
Per unit	Tax is calculated per unit of measure.
TaxTax	Tax is calculated on a tax.

CURRENCY Select the Currency Symbol or Abbreviation and press ENTER

SYMBOL	
\$	Dollar
£	Pound
¥	Yen

ABBREVIATION	
USD	US Dollar
EUR	Euro
GBP	British Pound Sterling
CAD	Canadian Dollar
MXN	Mexican Peso
CLP	Chilean Peso
JPY	Japanese Yen
BGN	Bulgarian Lev
CHF	Swiss Franc
CZK	Czech Republic Koruna
DKK	Danish Krone
HUF	Hungarian Forint
LVL	Latvian Lats
LTL	Lithuanian Litas
NGN	Nigerian Naira
PLN	Polish Zloty
RON	Romanian Leu
SEK	Swedish Krona
VND	Vietnamese Dong

3) ACTIVATE PRODUCT

Activate Product allows you to activate a product for a specific Shift. When liquid in your tank changes, you can change the product and calibration to match.

- To Activate a product, highlight the product and press ENTER.

4) DEACTIVATE PRODUCT

Deactivate Product allows you to deactivate an active Shift product. When liquid in your tank changes, you can also change the product.

5) PRODUCT PARAMETERS

Product Timing allows auxiliary device settings to be changed to suite the needs of the application. Currently set up for Preset Valve, Air Eliminator Hold and Hose Volume. Product Timing is product specific, adjusting the actuation or closure type.

PRESET TIMING

Preset Timing adjusts the valve closure type for preset or security valves. Highlight the Preset Timing function desired and press ENTER. This will be chosen as your default setting for the specific Product.

- | | |
|-----------|--|
| Full-Auto | Full Automatic tune preset shutoff for Solenoid S1 (fast) and S2 (slow) flow valves. Great for presets with varying system pressures.
NOTE: Solenoid S1 (fast) flow closure is 20% of average flow rate. |
| Semi-Auto | Semi-Automatic tuned preset shutoff for Solenoid S2 (slow) flow valve. Highlight Semi Auto and press ENTER. Input Solenoid S1 (fast) flow valve closure and press ENTER. |
| Next Fix | Next Fix is an automatic tune shutoff, however it will allow the preset to overrun batch amount. Designed to automatically correct the shutoff on the next preset delivery. Highlight Next Fix and press ENTER. Input Solenoid S1 (fast) flow valve closure and press ENTER. |
| Static | Static settings for the Solenoid S1 (fast) and S2 (slow) flow valves. There is no automatic correction for zero point shutoff. Highlight Static and press ENTER. Input Solenoid S1 (fast) flow valve closure and Solenoid S2 (slow) flow valve Values and press ENTER.
NOTE: for Solenoid S2 (slow) flow valve timing, run a separate preset batch with the S2 at Zero. What volume is over run and read on the screen after the shutoff should be input into the S2 (slow) valve timing. |

AIR ELIMINATOR HOLD

When the TCS 3000 senses air, the Solenoid S1 and S2 preset relays will de-energize for closure and energize the Auxiliary Relay open for the exhaust port to remove air from the system. Highlight Air Eliminator Hold and press Enter.

The HOLD (s) is the adjustable setting for the Auxiliary Relay closure in Seconds. Input value in Seconds and press ENTER.

STARTUP VOLUME

Is a soft-start mechanism at the beginning of a delivery through which the S1 fast flow valve will stay closed for scalable time (Seconds). Startup Volume will work with either the Valve Type 1101 or 1001 valve actuation.

6) AUXILIARY SETTINGS

Adjust the settings of the auxiliary sensors by first selecting the product the sensor is being used with.

- ADDITIVE INJECTOR** Select which setting you wish to be active. Only one can be chosen.
- None No Injector
 - External A constant positive signal output is provided during product delivery.
NOTE: Additive Injector controls injection pump rate.
 - Piston - A pulsing positive signal output is provided during product delivery.
NOTE: TCS 3000 controls the Additive Injector Pump
- CORR. DP. LIMIT** Differential Pressure is calculated from the Inlet and Outlet of a filter vessel. Set the THRESHOLD value of maximum pressure the measuring system is allowed to operate. Once the Corrected Differential Pressure Limit has been met, the TCS 3000 registration Will terminate the delivery. An advisory message will be displayed on the delivery screen and the Interlock Error will print on the ticket.
- PRESSURE SENSOR** Select with setting you wish to be active. Only one can be chosen. Uncorrected (Measured) Differential Pressure should be calibrated prior to use. See Filter Capacity below for calibration instructions.
- None Nothing is selected.
 - DP1 X1 Channel Single channel only allows you to use 1 device with the TCS 3000 (1 Differential Pressure or Level Gauge). NOTE: The single channel analog communication board is mounted within the TCS 3000 register. This should be ordered from the factory, but can be mounted after market. Must choose the input:
 - Voltage (5 Vdc Capacity)
 - Current (4 - 20 mA)
 - DP2 X8 Channel Eight channel allows you to use up to 8 auxiliary devices with the TCS 3000 for Level and Pressure. NOTE: Externally mounted from the TCS 3000 register in a NEMA 4X enclosure.
 - Level Meters (1 - 6)
 - Voltage (5 Vdc Capacity)
 - Current (4 - 20 mA)
 - Pressure (7 - 8)
 - Voltage (5 Vdc Capacity)
 - Current (4 - 20 mA)
- FILTER CAPACITY** Enter in the Filter Vessel's certified rated flow rate capacity rating. Value is used for the Corrected Differential Pressure formula. *To read the MEASURED DIFFERENTIAL PRESSURE, enter a value of ZERO to disable the Filter Capacity. This will allow you to calibrate auxiliary differential pressure gauges externally.*

Differential Pressure is calculated from the Inlet and Outlet of a filter vessel. A pressure differential pressure sensor is required for this setting. The Corrected Differential Pressure is generally calculated with the following formula:

$$\frac{\text{SYSTEM FLOW CAPACITY}}{\text{ACTUAL FLOW RATE}} \times \text{DIFFERENTIAL PRESSURE} = \text{CORRECTED DIFFERENTIAL PRESSURE}$$

Corrected Differential Pressure will illustrate the corrected value of the Inlet and Outlet pressure differential when Filter Vessel Systems are not being operated at maximum capacity.

7) PROUCT LISTS

Displays a list of Active, Inactive and Un-Calibrated products on the TCS 3000. To view these Products, highlight the selection and press ENTER.

Advanced Functions

- LOCK THE SYSTEM** Enter Access Key to lock the TCS 3000 register from local use. This feature is only available for remote computers (i.e. handhelds, tablets, mobile phones, etc.).
- SYSTEM SHUTDOWN** System Shutdown Shuts the TCS3000 down. You must cut power to the TCS 3000 and reboot to turn the unit back on.
- SYSTEM UPDATE** System Update allows you to upgrade the TCS 3000 Software. NOTE: Update process does NOT change Weights & Measures settings or parameters.

Procedure to upload new software is as follows:

- 1) Load new software upgrade to a USB thumb drive (dongle). Specifications for the USB thumb drive should be 8 Gigabytes and formatted to FAT 32.

NOTE: The new software upgrade should be the ONLY file on the drive.

- 2) Open the TCS 3000 register. On the front cover of the register, there are 2 mini-USB connections.. Using a factory supplied USB cable, attach the thumb drive to the USB1 port closest to the inside of the register. This port is the highest on the circuit board of the two. See Figure 1.
- 3) Plug the USB cable into the USB1 port, and then insert the USB thumb drive into the mating cable. See Figure 1.
- 4) Under Advanced Functions, locate System Update and press ENTER.
- 5) The screen will display System Update, press MODE to continue with the update.
- 6) If the thumb drive is not recognized or there is a faulty cable, the display will respond with NO UPDATE DATA error message.
- 7) Once the file is recognized, the operating system will begin the update process. This should take approximately 3 minutes.
NOTE: Do not power down or pull USB thumb drive until the TCS3000 tells you to do so.
- 8) You may remove the USB cable and close the TCS 3000 register once the Update is Complete.

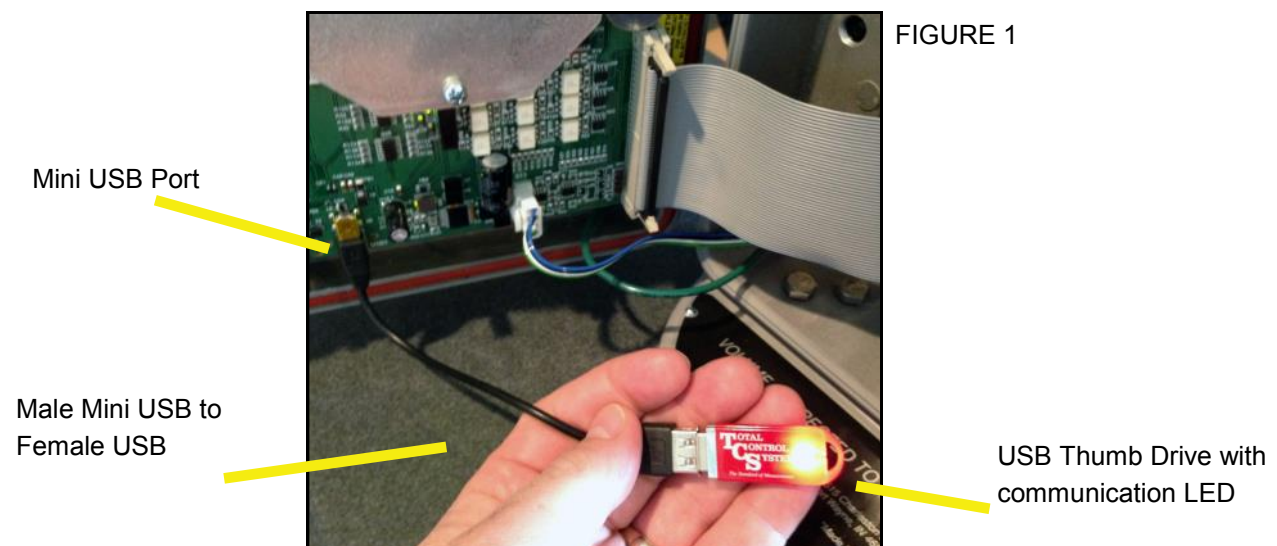

EXPORT TICKET CONFIG Feature not available at this time.

Installation Procedure — Daisy Chain

Daisy Chain:

Daisy Chain is used for linking multiple registers together to use one printer or to link multiple registers to the data-base.



To Daisy Chain the Registers use a two wire 22 gauge shielded cable. Nominate one Register to be the Host.

Once you've chosen which Register will be the Host the other Registers will be considered the clients. Strip a small amount of wire and run the wire from slot A and B of DAISY CHAIN on the Host Unit to slot A and B of DAISY CHAIN on the Client Unit.

To tie the Client to the next Client unit on the Daisy Chain, strip a small amount of wire and run the wire from slot A and B of DAISY CHAIN to slot A and B of the next client's DAISY CHAIN.



Host

Client 2

Client 3

Client 4

The Host will have 2 wires.

Client 2 will have 4 wires.

Client 3 will have 4 wires.

The Last Client will have 2 wires.



Continue to Daisy Chain until you have tied the chain together, alternating slots on the Daisy Chain until you've reached the end of the chain. The Host and the last Client on the chain will be the only two registers on the chain to have a one wire connection.

Daisy Chain for the Printer

Connect the Printer to the Host Register. To set the Host :

Enable the Printer:

SYSTEM MENU → SYSTEM SETTINGS → PRINTER SETTINGS → ENABLE/DISABLE PRINTER → ENABLE PRINTER

Select the Printer:

PRINTER SETTINGS → SELECT PRINTER → [SELECTED PRINTER] → ENABLE

Selecting the Host Register

Select Register as Host:

PRINTER SETTINGS → DISABLE/ENABLE HOST → ENABLE

Select the Client Range:

PRINTER SETTINGS → PRINTER HOST → CLIENTS ADDRESS RANGE → CLIENTS RANGE START ADDRESS [Enter 2 and Select] →

CLIENTS RANGE END ADDRESS [Enter the number of Registers on the Chain and Select]

Please Note the Host is always # 1. The Client always starts at #2

Selecting the Client Register

***If you are not using the Daisy Chain for the Printer Please Disregard the Enabling and Selecting the Printer Steps.**

Enable the Printer:*

PRINTER SETTINGS → ENABLE/DISABLE PRINTER → ENABLE PRINTER

Select the Printer:*

PRINTER SETTINGS → SELECT PRINTER → [REMOTE] → ENABLE

SYSTEM SETTINGS → CONNECTIVITY SETTINGS → NETWORK SETTINGS → ADDRESS → DEVICE ADDRESS [Select the number of the unit you are using ex. 2 if it is the second register on the chain or 3 if it's the third register on the chain.]

To Connect to the Chain:

SYSTEM SETTINGS → CONNECTIVITY SETTINGS → NETWORK SETTINGS → INTERFACE BRIDGE [Only used when there are 2 Registers tied in the chain] → TRANSFER DATA BETWEEN RS232 <-> RS485 INTERFACES ENABLED

Continue the Selecting Client Register steps for every Client on the Chain.

Real Time Inventory How To

Manual Inventory How To

Please note, you must End Shift before you may Add or Remove Inventory

Real Time Inventory is for Automatic Tank Levels Only

Add Inventory:

While holding Shift select Mode → System Menu → Product Settings → Inventory → Add Inventory → GIVE INVENTORY NAME (Use the Keypad to assign a name, ex. Av Gas, Gasoline, Tank 1, Tank 2, etc.) → Select Unit Volume (Gallons, Liters) → ENTER CAPACITY (Tank Size) → ENTER INVENTORY (Actual Known Inventory) → Press Any Key to Continue

Assign Inventory:

Assign Inventory → Select an Active Product → Assign the Active Product to an Inventory List → Press Any Key to Continue

Please Note You can apply multiple inventories to one meter.

Update Inventory:

Update Inventory → Level Meter → Select CH# (Ex. If Product 1 is tied to CH2, then you select LVL2) →

Inventory Update Message → Press Any Key to Continue

Please Note: Use CH2-6

Also Note: Level Meter will only update when there is no movement.

To Check the Changes:

Update Inventory → Level Meter → The LVL# you selected should be highlighted.

*If you enter into this screen and None is highlighted, then the unit does not see the circuit board or the Madison Gauge.

A ticket will generate if a printer is set up.

Remove Inventory:

Remove Inventory → Select Inventory → Press Mode to Confirm

Print Inventory Report:

View Inventory → Print Inventory Report

Bill of Lading:

Once you have finished in Inventory, select STOP/CANCEL →

ENTER BILL Nr. → START/ENTER

Add Inventory:

While holding Shift select Mode → System Menu → Product Settings → Inventory → Add Inventory → GIVE INVENTORY NAME (Use the Keypad to assign a name, ex. Av Gas, Gasoline, etc.) → Select Unit Volume (Gallons, Liters) → ENTER CAPACITY (Tank Size) → ENTER INVENTORY (Actual Known Inventory) → Press Any Key to Continue

Assign Inventory:

Assign Inventory → Select an Active Product → Assign the Active Product to an Inventory List → Press Any Key to Continue

Please Note You can apply multiple inventories to one meter.

Update Inventory:

Update Inventory → ADD To Inventory → ENTER AMOUNT (Amount added to tank)

Set Inventory Value → ENTER CURRENT VALUE (Current amount of product in the tank)

Fill Up Inventory → Press Any Key to Continue (Resets Inventory to full capacity)

Empty Inventory → Press Any Key to Continue (Zero's out tank amount)

Remove Inventory:

Remove Inventory → Select Inventory → Press Mode to Confirm

Print Inventory Report:

View Inventory → Print Inventory Report

Bill of Lading:

Once you have finished in Inventory, select STOP/CANCEL →

ENTER BILL Nr. → START/ENTER

Inventory Short Cut

In the Delivery Screen:

Hold down SHIFT and select PRINT (while holding Shift)

You can enter inventory through the short cut only after you've set up and assigned inventory.

Color Guide: Blue: Operating Volume

Yellow: 25% Cautionary Volume

Red: 10% Low Volume

TEMPERATURE PROBE CALIBRATION HOW TO

* The following is based on product(s) you have calibrated. You must select the compensation table and the temperature unit for the product when Calibrating your product in order to Calibrate Temperature.*

Press Shift and Mode to enter the Select Function Screen.

Use the arrow keys to highlight SYSTEM MENU and Select START/ENTER.

Remove the Calibration Bolt and set in a safe location.

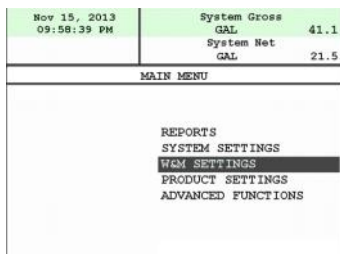

Use the arrow keys to highlight W&M SETTING. Select START/ENTER.

Use the arrow keys to highlight your product. Select START/ENTER.

Use the arrow keys to highlight PRODUCT TEST RUN. Select START/ENTER.

Use the arrow keys to highlight your product. Select START/ENTER.

Use the arrow keys to highlight TEMP PROBE select START/ENTER.

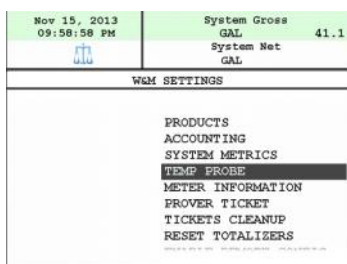

Selecting TEMP PROBE will take you to Offset Calibration
Press START/ENTER
(You are now calibrating the TCS3000 Register Temperature Probe to the Weights and Measures Temperature Probe)

Use the arrow keys to highlight the Reference Temperature select START/ENTER.

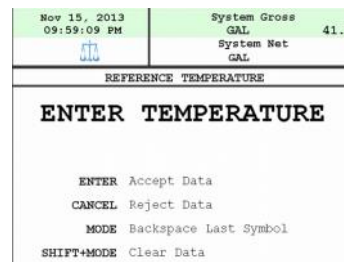
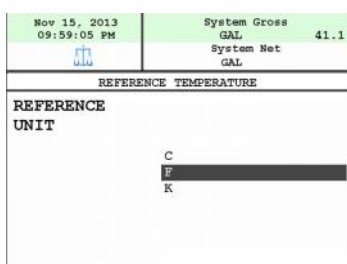

*Note: You will want to take 3 temperature readings during a run to get the average temperature.



Enter the Average Temperature Select START/ENTER

*Note: The register will display that it is calibrating and is applying the corrections. It will take a minute to calibrate the RTD Probe to the Weights & Measures Probe.

When Calibration is done the Register will display the following message:

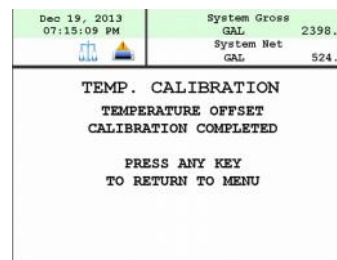

Repeat the steps if necessary.

Trouble Shooting

The TCS3000 troubleshooting guide covers most common problem situations. Call your Total Controls Service Center for any problems that are not covered in this guide.

NOTICE	DANGER
<p>It may be necessary to break Weights & Measure seals to perform certain troubleshooting steps in this guide. Contact your supervisor or local Weights & Measures authorities for information before breaking any seals.</p>	<p>Serious Injury or Death may Result – Fire, Explosion, and Electrical Shock Hazard.</p> <p>Only trained and authorized personnel should perform troubleshooting. Use extreme caution when troubleshooting and taking all electrical measurements. Be sure that equipment is in a well ventilated area and that hazardous or flammable vapors are not and will not be present during testing. If equipment is located in a hazardous environment, it may be necessary to remove the equipment and perform troubleshooting in a safe area.</p>

TOOLS/MATERIALS:

- #2, #3 and #5 Metric Allen Wrenches
- 7/16", 1/2" and 1-1/8" Wrenches
- Digital Multimeter
- 8G Thumb Drive (FAT 32) with TCS USB Adapter
- Wire Stripper
- RTV Silicone
- Electrical Tape/Heat Shrink

Trouble Shooting Guidelines:

1. Before attempting to troubleshoot the TCS3000 system, become familiar with the operation and set-up of the specific installation.
2. Make sure all electrical connections are secure and tight.
3. Make sure all terminal blocks are firmly connected.
4. ALWAYS use a good digital multimeter. Voltage levels are critical to proper system operation. Use an accurate, reliable multimeter to test for proper voltages at the start of any service procedure. Voltage requirements are listed under each component.

NOTE: Check for proper operating voltages before changing the circuit board. If the circuit board needs to be changed, be sure to remove all power to the TCS3000.









5. NEVER remove a terminal block or jumper with the power on.
6. NEVER install a terminal block or jumper with the power on.
7. NEVER force a terminal block into its location.
8. NEVER exchange or reposition terminal blocks on the circuit board.
9. In case of a major problem such as a burned or water-damaged circuit board, evaluate possible causes before replacing it and turn the power back on.
10. Isolate the problem before changing the circuit board.
11. Return faulty circuit boards with the proper RMA forms, concisely completed.

There may be several probable causes for a system malfunction. The following list are several probable causes to aid in returning the system to operation as quickly as possible. Should you require contact with Total Control Systems factory support, please provide the following information to help manage the problem.

REPORTS: Shift + Mode -> System Menu -> Reports

- 1) TCS 3000 Serial Number under Meter Information
- 2) Software and Firmware under Version Information
- 3) Print Prover Ticket before any changes are made to system settings.

BASIC DISPLAY ICON INDICATION

ICON	INDICATION	SOLUTION
	Printer is connected with paper	Printer is Enabled, connected and with paper. Awaiting delivery.
	Printer is out of paper	Printer Enabled, connected, but without paper.
	No printer connection	Printer has no communication with TCS Register Check cable for damage Epson printer DIP switch should be on 3 Power supply fuse is blown
	Valve or Pump not open in Delivery	Valve or Pump are closed within delivery. Pump Starter delay timing can be adjusted under W&M Settings.
	Active delivery	Valve or Pump Enabled
	Multiple Tank Delivery	Multiple Tank Delivery is Enabled and begun by pressing Shift + Start
	You're in System Settings Screen	Exit out and go to the Delivery Screen
	You're in Weights & Measure Settings	Only shows when in W&M Settings. To remove, make sure the calibration screw on the register is screwed in.
AIR	Air is present in system or level sensor is low or high	The Air Eliminator Detection is Enabled.

We will categorize Troubleshooting with **HARDWARE/SOFTWARE**, **SYSTEM**, **WEIGHTS & MEASURES** and **PRODUCT** Settings in the TCS 3000 Register. TCS HUB and Modem Settings follow register troubleshooting. The list is not all-inclusive and should only be used as a guide.

HARDWARE/SOFTWARE TROUBLESHOOTING

PROBLEM	PROBABLE CAUSE	SOLUTION
Unit will not power up or there is no display.	Inadequate supply voltage, +9 to 28VDC are required for operation. Ground short on terminals, wire harness or lug.	<ol style="list-style-type: none"> 1. With the key in the accessory position, check the battery voltage to the circuit board. Use the negative terminal as DC ground. While the TCS3000 will power-up at +9VDC, it is recommended that the input be at least +12.6VDC. 2. There is a ground short within the register or on the cable harness. Check wiring on grounds in register or chassis. Some ground shorts come from a cable jacket being worn through with a tie-down. 3. Check the 7.5A, in-line fuse for continuity. It is located in the accessory power line. Replace if necessary. 4. If the green light blinks fast it is doing what it is supposed to, but then it will go to a slow blink. If you see red, then you do not have enough power on the register. It must see a minimum of 9vdc. 5. If the red light comes on and the unit doesn't power-up. Check the voltage if the voltage is OK but the temperature is -20 F this will indicate that the heater is warming the display to prevent any damage to the VGA display and should come-up shortly.

HARDWARE/SOFTWARE TROUBLESHOOTING (CONTINUED)

PROBLEM	PROBABLE CAUSE	SOLUTION
Unit blows 7.5A fuse.	+12VDC Battery line is shorted to ground.	<ol style="list-style-type: none"> 1. For safety reasons, remove the 7.5A, in-line fuse from the accessory power cable. 2. Unscrew the 3 pin power connector. Inspect for stray wire strands and visible shorts. 3. Inspect the full length of the power cable. Look for damaged insulation, which may cause shorting between the cable and ground potential (e.g. truck frame or chassis). If the power cable is damaged, it must be replaced. 4. Replace the 7.5A fuse and re-install the wires into the terminal Bd. connector. 5. If the 7.5A blows again, then replace the power cable. 6. If the 7.5A fuse blows after replacing the power cable, then replace the TCS3000 terminal circuit board.
Display is reading in reverse	Pulse Channel TAHA1 and TAHB1 are wired backwards	Switch Pulser wiring between Channel A and B.
Black display screen but power LED indicator is on.	Sufficient power to the register, however there may be a current draw from the system that will not allow the register display to power up properly.	<ol style="list-style-type: none"> 1. Cycle power of the register 2. Allow diesel chassis glow plugs to properly charge before turning over the ignition. 3. Power On Time Relay may be required for installation. 4. Contact factory for further support.
Time and Date reset to 10/28/13	Low Battery Power Short on Battery	<ol style="list-style-type: none"> 1. Go to Operation Status under Reports and check internal battery voltage. If under 2.75V, battery must be replaced. 2. Check that no wires are in contact with Battery. Time and Date are reset if in contact and power is shutoff. Use electrical tape or heat shrink on bare wire to prevent from happening again. 3. If time and date reset each time you cycle power, change Time Source from Controller to BIOS in Regional Settings.
Display screen has multiple colored lines.	Ribbon cable is not seated properly.	<ol style="list-style-type: none"> 1. Contact factory for further support. 2. Disassemble the front cover of the register to reseal the display ribbon cable.
Buttons on my keyboard are not active.	Tactile button has been damaged.	<ol style="list-style-type: none"> 1. Contact factory for further support. 2. Disassemble the front cover of the register to replace keyboard.
System One Error	New Software not compatible with existing Firmware	<ol style="list-style-type: none"> 1. Press STOP/CANCEL to back out of a level and continue with normal operation of the register. This code detects software features that not compatible with existing firmware. 2. Some functions will not operate (Additive Injection, Differential Pressure, etc.) under old Firmware. 3. Contact factory for Firmware upgrade.
Register reboots in Idle or Delivery	Ground Short	<ol style="list-style-type: none"> 1. Loose ground wire causing short. Check power distribution box and TCS 3000 register for loose grounds. Find and tighten. 2. Inadequate power due to current draw from hose reel or solenoid coil.
Operating System (OS) Error Controller Com Error Grub Error Root Password Error	OS loading error during boot up	<ol style="list-style-type: none"> 1. OS loading errors occur during startup. Voltage spikes or current draws during OS bootup can corrupt software. 2. Contact factory for replacement.

SYSTEM SETTINGS TROUBLESHOOTING

PROBLEM	PROBABLE CAUSE	SOLUTION
Display screen is incorrect	Default display is chosen	<ol style="list-style-type: none"> 1. If a different display screen is shown, it's possible the customer pushed Mode to flip to a different display screen than the Default screen. 2. If a different display screen is shown during a delivery, then the Default display screen must be changed. See Display Settings under System Settings for correction.
Display is too dim, or too bright	Display brightness was not adjusted for current environment	<ol style="list-style-type: none"> 1. The Brightness can be adjusted from 30% to 100%. 2. There is no "Sleep" mode.
Daisy chain communication is not working	<p>Network Address of registers are not in proper sequence</p> <p>Printer Host and Client Addresses are not in proper sequence</p>	<ol style="list-style-type: none"> 1. Check the RX and TX wiring between registers. 2. Make sure the printer is wired to the primary HOST register. 3. Check the Device Addresses of each register, with the primary HOST as 1 and Clients 2 to 8. 4. Make sure the primary HOST register has the Client Address Range set to communicate with all the TCS 3000 registers in the daisy chain. 5. Client addresses must have REMOTE PRINTER selected to be able to print delivery tickets. NOTE: Remote Printer has no effect on wireless data transfer.
Delivery Not Completed	Previous delivery ticket was not printed	<ol style="list-style-type: none"> 1. Press Print to print previous ticket. 2. Keep Master Switch on until delivery ticket has printed. 3. Make sure the correct printer is selected. 4. Make sure TCS 3000 address is correct for each register. 5. Check power and communication cables for proper connection or damage. 6. On initial use of Epson printer, you must cycle power on printer after #3 dip switch is turned on. 7. Printer Error light is flashing. If rebooting the printer does not eliminate the error light, printer must be replaced. 8. If printer or cable connection is damaged, you must replace. Disable printer and continue use.
Epson printer release light flashes.	Low voltage to the Epson printer.	<ol style="list-style-type: none"> 1. Check the battery voltage for a minimum of +12.6VDC. 2. Under extreme cold conditions, the printer may not operate. Warm up the cab of the vehicle. 3. If the release light continues to flash, replace the Epson 295 Printer.
No power indicator lights to the Epson printer.	No power to the Epson printer.	<ol style="list-style-type: none"> 1. Verify that the power switch is in the ON position. This switch is located on the left-hand side of the Epson 295 Printer. 2. Verify that the printer power supply fuse is not blown. 3. Check the printer power cable to ensure that it is seated properly. If the problem persists, replace the power cable followed by the Epson printer.
Time and Date are incorrect	Time and Date were not configured to region	<ol style="list-style-type: none"> 1. Go Regional Settings to adjust time and date, as well as format. 2. Set Time through the 24 hour clock, and be sure to use "Periods" between Hours:Minutes:Seconds 3. There is no Daylight Time Zone adjustment. 4. TCS HUB may be setup to sync with Register for time change.
After preset, display shows a "Pause" and will not finished transaction.	Preset Top-Up or Delivery Pause is Enabled	<ol style="list-style-type: none"> 1. Go to Preset Settings and Disable Preset Top-Up. 2. Go to Pause Options and select Allow Pause, then Disable.

SYSTEM SETTINGS TROUBLESHOOTING (CONTINUED)

PROBLEM	PROBABLE CAUSE	SOLUTION
The Delivery Prompts are incorrect	Customer ID options have not be configured	<ol style="list-style-type: none"> 1. Determine what questions must be asked and enter into Customer ID 1 to 4 text. 2. If question does not show, make sure the Request is enabled. 3. To make sure operator enters data into Customer ID 1 to 4, make sure Enforce is Enabled. 4. Validation only works if a Database has been loaded. Contact TCS for further support.
Display Precision is incorrect	Precision changed for calibration	<ol style="list-style-type: none"> 1. There are two places to change display precision: 2. W&M Settings under System Metrics 3. System Settings under Delivery Settings
Delivery ends during fueling	Delivery Timed Out	Under Delivery Settings, you must extend your Time Out setting from 180 or 600 seconds.
External Display is not reading	Red Lion or Tekkino Serial Display settings are not Enabled	<ol style="list-style-type: none"> 1. Go to Auxiliary Devices and Enable External Display. 2. Choose what is to be displayed under Configure 3. Pulse driven displays from Red Lion must be configured correct. Contact Red Lion for support.
I lost my passwords	Passwords are not stored locally	Contact TCS for factory support.

WEIGHTS & MEASURES SETTINGS TROUBLESHOOTING

PROBLEM	PROBABLE CAUSE	SOLUTION
Product has wrong Name	The Register was never calibrated	Go into W&M Settings and select product to change name or add new product, then calibrate the product.
Metered volume not the same as Delivered Volume	Product calibration factor was not properly entered for 2 nd product.	<ol style="list-style-type: none"> 1. Under W&M Settings, read Product 1001 calibration factor and copy it to Product 1002 under Edit Product Calibration. 2. Entering calibration factors under Product Parameters will require a physical calibration operation.
When Product with Additive Pump is selected, I do not see or hear the Injector actuating.	<p>Additive Injector Pump is not Enabled for Product</p> <p>Injector Pump not primed or has leak</p>	<ol style="list-style-type: none"> 1. Go to Product Parameters of Product with the enabled Injector Pump, then make sure Additive Injector is on External or Piston. 2. Check that pump wiring is terminated correctly on Pump Starter and not reading 9V. If reading 0 or 12V, check the solenoid coil on the Injector Pump. 3. Look for leaking fitting on suction side of Injector Pump. 4. Prime Injector Pump
Ticket is not set up correctly	Ticket must be configured	<ol style="list-style-type: none"> 1. Go to Accounting and select Configure Ticket 2. Adjust Ticket configuration by adding, removing or editing each line. See ticket setup in the TCS User's Guide for more information.
Customer contact information is missing from ticket	Customer contact information is not setup in Header or Footer	<ol style="list-style-type: none"> 1. Go to Accounting and select Configure Ticket. 2. Header and Footer Defaults for customer contact information or messages can be entered here.
Delivery ticket will not print	<p>Out of paper or printer not connected</p> <p>Missing Minimum Ticket</p>	<ol style="list-style-type: none"> 1. Load paper ticket and press Print. 2. Check cable connection and termination of printer wiring for loose connection. 3. Check for worn cable throughout chassis. 4. Missing "Minimum" Ticket. Requires a copy from Existing Ticket and named Minimum.

WEIGHTS & MEASURES SETTINGS TROUBLESHOOTING (CONTINUED)

PROBLEM	PROBABLE CAUSE	SOLUTION
Preset Valve will not open.	Solenoids are inactive or inoperative. Foreign debris in system.	<ol style="list-style-type: none"> 1. Start a delivery and listen for the audible clicking sound from the solenoids. 2. If there is an audible click from the solenoid (but still no flow), this may be an indication of a mechanical problem with the main valve or its associate components. 3. If there is NO audible click form the solenoid, check the voltage to Pin + and 0V of terminal block Solenoid 1. While the TCS3000 is still in delivery, use a reliable multimeter to measure the following DC voltages on the circuit board. Use 0 pin as a ground or frame ground. TERMINAL SOLENOID 1 for 2 VOLTAGE 9.0 VDC with plug remove VDC (NO LOAD) 2.0 VDC with solenoid connected 12.0 VDC with the solenoid energized 4. If the above voltages are correct, this may be an indication of a problem with the valve or its associated components. 5. Check for pinched 50 pin communication cable in register. 6. If the above voltage are NOT correct, replace the Solenoids and/or TCS3000 terminal board.
Preset Valve doesn't shut off or pulsates	Valve was never set-up and calibrated.	<ol style="list-style-type: none"> 1. Valve settings by product are not correctly setup. Check the following W&M -> Product Settings for minimum values: - S1-S2 Delay should be 2 seconds or more. - S2 Delay should be 0.2 seconds or more. - Maximum Flow Rate should be at least the maximum flow rate of flow meter. 2. Run full calibration, followed by Full Auto preset setting. Allow preset to run in its entirety. NOTE: S2 is set for 20% of preset value. 3. If preset solenoids continue to click, double the Maximum Flow Rate within Product Parameters.
Delivery does not begin at Zero	Hose Charge is set too high	Hose Charge under Product Parameters is set too high. Change accordingly. NOTE: Hose Charge can be disabled.
Maximum Pulser Error	Noise from truck is creating false pulse transmissions	<ol style="list-style-type: none"> 1. Make sure that pulser cable leads are foil wrapped with a shield drain 2. Only terminate the shield drain to the TCS 3000 register, and not the Direct Mount Pulser. 3. Change Maximum Pulser Error to maximum allowable error of 255. 4. Direct Mount Pulser has a shunt for 5V and 9-30V, check that the shunt is on 5V 5. Ferrite Coupling over pulse encoder cable. 6. Insulate the TCS 3000 register from chassis and place ground to battery.
Missing Pulse Channel Error	One pulse channel is missing from the Dual or Quadrature pulser setting or pulse encoder has failed.	<ol style="list-style-type: none"> 1. Check wiring of the A and B channel wiring on the TCS 3000 register for good termination. 2. Direct Mount Pulser has two LED indications for each channel. If product is flowing and one of these is not lit, then we have a bad encoder and it needs changed. 3. Direct Mount Pulser has a shunt for 5V and 9-30V, check that the shunt is on 5V

WEIGHTS & MEASURES SETTINGS TROUBLESHOOTING (CONTINUED)

PROBLEM	PROBABLE CAUSE	1 SOLUTION
2 Temperature Error	3 Open or shorted circuit between the RTD probe and the TCS3000.	<ol style="list-style-type: none"> 1. Check the RTD Probe and terminal block for continuity. 2. RTD Probe requires 4 wire leads. 3. Remove terminal block Temp Probe from the circuit board. On the terminal block, measure and record the resistance between the following pins: <u>PIN READING</u> Red to White 100 Ω ±20 ohms 4. If the readings are not within the above tolerances, replace the RTD probe.

PRODUCT SETTINGS TROUBLESHOOTING

PROBLEM	PROBABLE CAUSE	SOLUTION
Inventory does not change	Active Products have not been assigned to Tank Identification.	<ol style="list-style-type: none"> 1. Go into Inventory under Product Settings and Assign Inventory. Select Active Product and then choose the Tank Identification it is to be assigned to. 2. For multiple products, you must Assign each product to one or more Tank Identification.
Inventory shows a negative	Manual Inventory needs to be reset Live Inventory is not Enabled	<ol style="list-style-type: none"> 1. Go into Inventory under Product Settings and update Inventory. Select Tank Identification and go to Fill Up Inventory. This will reset Inventory to 100% capacity. NOTE: Shift + Print takes you Inventory List for quick reset. 2. Go to Inventory List and then Update Inventory. Select Tank Identification and choose Level Meter. Select LVL1 for the single compartment tank. <p>NOTE: You must have the Analog Input set to X1 or X8 CHANNEL Communication and CURRENT under System Settings/Aux Devices for Live Inventory to be correct.</p>
Cannot find the added New Product	Product is not Active	<ol style="list-style-type: none"> 1. End Shift and go to Product Settings. 2. Select Activate Product and choose new product from list. 3. Begin Shift 4. Remove unwanted products either in W&M Settings or disable unwanted product in Product Settings. <p>NOTE: Products that have been calibrated may appear either as an Active or Inactive Product. The TCS 3000 must have at least 1 Active Product in order to Begin a Shift and Start a Delivery. Products may only be Activated or Deactivated after a Shift has Ended.</p>
Preset valves are cutting in and out (chatter) during delivery	Preset Timing needs to be configured	<ol style="list-style-type: none"> 1. Go to Product Timing and select Preset Timing. 2. Select Product and Preset Timing to configure preset option. 3. There are four preset timing functions for the fast flow (S1) and slow flow (S2) preset shut off. <i>Full Auto</i> – Automatically Tunes S1 and S2 Shutoff <i>Semi Auto</i> – S1 is scalable and S2 automatically shuts off. <i>Next Fix</i> – S1 & S2 automatically correct the next preset delivery. <i>Static</i> – S1 & S2 are scalable. 4. To eliminate solenoid modulation, select Static and be sure to move S1 Fast Flow preset volume to 8 gallons or more. The S2 Slow Flow preset volume is near 0.1 gallons.

MODEM TROUBLESHOOTING

PROBLEM	PROBABLE CAUSE	SOLUTION
No transactions into the HUB	Communication wire not correct Connections to modem are loose Insufficient Power	<ol style="list-style-type: none"> 1. Check wiring in the TCS 3000 to be sure RX and TX wires are terminated and seated correctly. 2. 9 pin communication cable connection is loose on the modem (radio or cell). 3. Radio Modem communication cable's RED wire is not terminated into the 12VDC power source. 4. Reset button on Radio Modem has been pressed. Contact factory for replacement. 5. Cell Modem communication cable's RED wire is terminated into the 12VDC power source and not the provided power plug.
I cannot determine if all transactions have been transmitted	Memory Status	Go to Memory Status under Reports to find delivery ticket status. If any number of tickets are in the Non-Transferred directory, we know there must be a communication or software failure.

RADIO MODEM SETTINGS

DIP Switch Settings

- 1 = ON
- 2 = OFF
- 3 = OFF
- 4 = OFF
- 5 = ON
- 6 = OFF

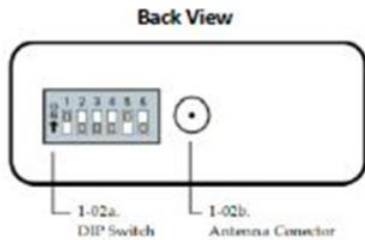

RSSI LEDs

(Green LED) indicates the amount of fade margin present in an active wireless link. Fade margin is defined as the difference between the incoming signal strength and the modem's receiver sensitivity.

- 3 LEDs ON = Very Strong Signal (> 30 dB fade Margin)
- 2 LEDs ON = Strong Signal (> 20 dB Fade Margin)
- 1 LED ON = Moderate Signal (> 10 dB Fade Margin)
- 0 LED ON = Weak Signal (< 10 dB Fade Margin)

Yellow light (Top) = DATA FROM OFFICE

Green light (Middle) = DATA TO OFFICE

Red light (Bottom) = POWER

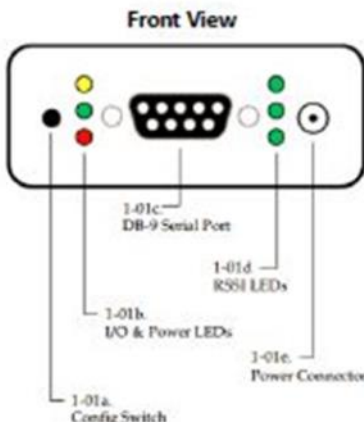

CELLULAR MODEM SETTINGS

LED operation is as follows:

- Off—No Activity
- Green—Full Function
- Yellow—Limited Function
- Red—Not Functional



Network:

- Green—On the network
- Flashing Green—Roaming
- Yellow—Found service, attempting to connect
- Flashing Yellow—Link Down
- Red—No data connection available

SIGNAL:

Light shows the strength of the signal and may be nearly solid (strong signal) or flashing (weaker signal). A slow flash indicates a very weak signal.

ACTIVITY:

Pulse Green on packet transmit/receive on the radio link.

POWER:

- Off—No power (above 36V or below 7.5V)
- Red—System not operational
- Green—Normal operation
- Green, Occasional Yellow—GPS Lock
- Yellow—Low power mode or system rebooting

TCS 3000 PARTS LIST

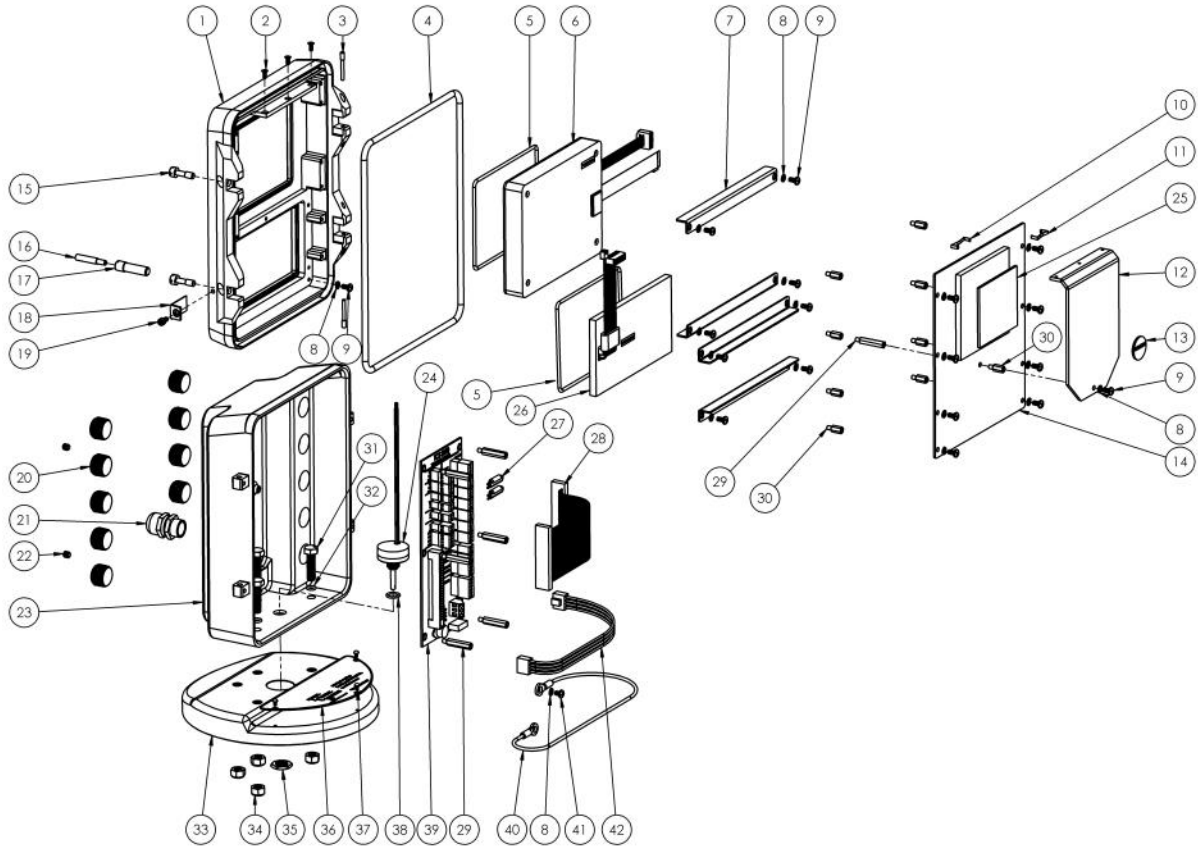

Item	Part No.	Description	Quantity
1	TCS300150	Front Cover	1
2	TCS300122	Countersunk Screw	3
3	TCS300172	Hinge Pin	2
4	TCS300174	Gasket Cover	1
5	TCS300144	Gasket Display / Keyboard	2
6	TCS300320	Display w/ Screen Protector	1
7	TCS300131	Compression Bar	4
8	TCS300138	Washer	18
9	TCS300137	Screw	18
10	TCS300261	Retaining Clip	1
11	TCS300260	Retaining Clip	1
12	TCS300120	Radiator	1
13	TCS300797	Replaceable Battery	1
14	TCS300110	PC Board Assembly	1
15	TCS300171	Socket Screw	2
16	TCS300156	Calibration Stud	1
17	TCS300158	Calibration Stud Body	1
18	TCS300153	Calibration Label	1
19	TCS300154	Drilled Calibration Screw	1
20	TCS300252	1/2" UL Plug	9
21	TCS300133	Cord Grip; 1/2" NPT Atex	1
22	TCS300173	Socket Set Screw	2
23A	TCS300275	75° Rear Housing; 1/2" NPT	1
23B	TCS300290	90° Rear Housing; 1/2" NPT	1

Item	Part No.	Description	Quantity
23C	TCS300280	Remote Rear Housing; 1/2" NPT	1
23D	TCS300175	Remote Rear Housing; M20	1
23E	TCS300190	Remote Rear Housing; M20	1
23F	TCS300180	Remote Rear Housing; M20	1
24	TCS300160	Pulse Encoder	1
25	TCS300148	Thermal Pad	1
26	TCS300230	Keyboard Assembly	1
27	TCS300759	1K Resistor	2
28	TCS300176	50 PIN Ribbon Cable	1
29	TCS300124	M4 x 27 Standoff	7
30	TCS300125	M4 x 11 Standoff	9
31	TCS300202	Screw	4
32	TCS300206	Oring	4
33	TCS300210	75°/90° Rear Housing Stand	1
34	TCS300204	Nylon Locknut	4
35	TCS300162	Pulser Nut	1
36	TCS300217	Name Plate	1
37	TCS790095	Drive Screw	3
38	TCS300166	Oring	1
39	TCS300112	Terminal Board w/ Connector	1
40	TCS300181	6" Grounding Wire	1
41	TCS300151	Screw	1
42	TCS300177	Power Ribbon Cable	1

—Warranty Information

WARRANTY

New 3000 electronic registers, equipment or components manufactured by Total Control Systems, a division of Murray Equipment, Inc. (TCS) with which this warranty is enclosed, are warranted by TCS to the original purchaser only for a period of TWELVE (12) months from installation or eighteen (18) months from the date of shipment, to be free, under normal use and service, from defects in material and workmanship.

Defects occurring within the stated warranty period, TCS will repair or replace, at TCS's option; provided that part or parts are returned to TCS transportation charges prepaid, and TCS's examination discloses the parts or workmanship to have been defective upon delivery to the purchaser.

EXCLUSIONS

Warranty does not cover any parts and equipment not manufactured by TCS, but these items may be covered by separate warranties of their respective manufacturers. This warranty does not extend to any equipment that has been subjected to misuse, negligence or accident or if operated in any manner other than in accordance with TCS's operating instructions and specifications.

CLAIM PROCEDURES

In order to obtain performance by TCS of its obligations under this warranty, the original purchaser must obtain a Return Goods Authorization (RGA) number from TCS's customer service department within 30 days of discovery of a purported breach of warranty, but not later than the expiration of the warranty period. Once authorization is received, return the defective meter, piece of equipment, or component covered by this warranty, with transportation charges prepaid, to TCS at the address shown below together with a written statement setting forth the nature of the defect and RGA number.

LIMITATIONS

THERE ARE NO OTHER WARRANTIES OF ANY KIND, EXPRESS OR IMPLIED. TCS SPECIFICALLY DISCLAIMS ANY WARRANTY OF MERCHANTABILITY OR OF FITNESS FOR ANY PARTICULAR PURPOSE. TCS will determine if all parts or meter defect falls within the warranty guidelines and will repair or replace within a reasonable time span. TCS is not responsible for any in or out bound freight. TCS's sole obligation that shall represent the buyer's sole and exclusive remedy shall be to repair or at TCS's option to replace any product or part determined to be defective. In no event shall TCS be liable for any special, direct, indirect, incident, consequential or other damages of similar nature, including without limitation, loss of profits, products, production time, or loss of expenses of any nature incurred by the buyer or any third party. TCS has not authorized on its behalf any representation or warranties to be made, nor any liability to be assumed except as expressly provided herein; there is no other express or implied warranty.

DESIGN AND EQUIPMENT CHANGES

Any changes in design or improvements added shall not create any obligation to install same on equipment previously sold or ordered.



The Standard of Measurement

2515 Charleston Place
Fort Wayne, IN 46808

Toll Free: (800) 348-4753
Phone: (260) 484-0382
Fax: (260) 484-9230
Email: sales@tcsimeters.com
Website: www.tcsimeters.com