

# SUPERtrol-I FLOW COMPUTER



# KEP

**KESSLER-ELLIS PRODUCTS**

10 Industrial Way East  
Eatontown, NJ 07724

800-631-2165 • 732-935-1320

Fax: 732-935-9344

**kep.com**  
<http://www.kep.com>





## WARNING!

Power, input and output (I/O) wiring must be in accordance with Class I, Division 2 wiring methods Article 501-4 (b) or the National Electrical Code, NFPA 70 for installations in the U.S., or as specified in Section 18-1J2 of the Canadian Electrical Code for installations within Canada and in accordance with the authority having jurisdiction.

1. This equipment is suitable for use in Class I, Division 2, Groups A, B, C, and D or Non-Hazardous Locations Only.
2. **WARNING - EXPLOSION HAZARD** - Substitution of components may impair suitability for Class I, Division 2.
3. **WARNING - EXPLOSION HAZARD** - Do not disconnect equipment unless power has been switched off or the area is known to be Non-Hazardous.



## WARNING!

This instrument contains electronic components that are susceptible to damage by static electricity. Proper handling\* procedures must be observed during the removal, installation, or handling of internal circuit boards or devices.

\*Handling Procedure

1. Power to unit must be removed.
2. Personnel must be grounded, via wrist strap or other safe, suitable means, before any printed circuit board or other internal device is installed, removed or adjusted.
3. Printed circuit boards must be transported in a conductive bag or other conductive container. Boards must not be removed from protective enclosure until the immediate time of installation. Removed boards must be placed immediately in protective container for transport, storage, or return to factory.

Comments

This instrument is not unique in its content of ESD (electrostatic discharge) sensitive components. Most modern electronic designs contain components that utilize metal oxide technology (NMOS, CMOS, etc.). Experience has proven that even small amounts of static electricity can damage or destroy these devices. Damaged components, even though they appear to function properly, may exhibit early failure.



## SAFETY INSTRUCTIONS

The following instructions must be observed.

- This instrument was designed and is checked in accordance with regulations in force EN 60950 (“Safety of information technology equipment, including electrical business equipment”). A hazardous situation may occur if this instrument is not used for its intended purpose or is used incorrectly. Please note operating instructions provided in this manual.
- The instrument must be installed, operated and maintained by personnel who have been properly trained. Personnel must read and understand this manual prior to installation and operation of the instrument.
- This instrument is internally fused. Replace the internal fuse with the following specified type and rating only:
 

<u>Input Power</u>	<u>Recommended Fuse</u>
115 VAC	160 mA slow blow fuse
230 VAC	80 mA slow blow fuse
12-24 VDC	800 mA slow blow fuse

**Disconnect power supply before replacing fuse!**

- The manufacturer assumes no liability for damage caused by incorrect use of the instrument or for modifications or changes made to the instrument.

### Symbols Used On Unit

<u>Number</u>	<u>Symbol</u>	<u>Publication</u>	<u>Description</u>
1		IEC 417, No. 5031	Direct current
2		IEC 417, No. 5172	Equipment protected throughout by DOUBLE INSULATION or REINFORCED INSULATION (equivalent to Class II of IEC 536—see annex H)
3		ISO 3864, No. B.3.1	Caution (refer to accompanying documents)

### Technical Improvements

- The manufacturer reserves the right to modify technical data without prior notice.

# CONTENTS

## 1. DESCRIPTION

1.1 Unit Description .....	1
1.2 Unit Features .....	1
1.3 Specifications .....	2

## 2. INSTALLATION

2.1 General Mounting Hints .....	6
2.2 Mounting Diagrams .....	6

## 3. APPLICATIONS

3.1 Liquid Volume .....	7
3.2 Corrected Liquid Volume .....	8
3.3 Liquid Mass .....	9
3.4 Batching .....	10

## 4. WIRING

4.1 Typical Batcher Wiring .....	11
4.2 Typical Rate/Total Wiring .....	11
4.3 Wiring In Hazardous Areas .....	12

## 5. UNIT OPERATION

5.1 Front Panel Operation Concept for Run Mode .....	13
5.2 General Operation .....	14
5.3 Ratemeter/Totalizer Operation .....	14
5.3.1 Password Protection for Rate/Total mode .....	14
5.3.2 Relay Operation in Rate/Total mode .....	14
5.3.3 Pulse Output in Rate/Total mode .....	14
5.3.4 Analog Output in Rate/Total mode .....	14
5.3.5 RS-232 Serial Port Operation in Rate/Total mode .....	15
5.3.6 RS-485 Serial Port Operation in Rate/Total mode .....	15
5.4 Batcher Operation .....	16
5.4.1 Batcher Configuration .....	16
5.4.2 Password Protection for Batcher mode .....	17
5.4.3 Relay Operation in Batcher mode .....	17
5.4.4 Pulse Output in Batcher mode .....	17
5.4.5 Analog Output in Batcher mode .....	17
5.4.6 RS-232 Serial Port Operation in Batcher mode .....	18
5.4.7 RS-485 Serial Port Operation in Batcher mode .....	18

## 6. PROGRAMMING

6.1 Front Panel Operation Concept for Program Mode .....	19
6.2 EZ Setup .....	20
6.3 Setup Menus .....	21
6.4 Setup Sub-Menus .....	22
6.4.1 SELECT EZ SETUP .....	22
6.4.2 INSTRUMENT TYPE .....	22
6.4.3 SELECT FLOW EQUATION .....	24
6.4.4 SETUP INDICATORS (Total) .....	24
6.4.5 SETUP INDICATORS (Density) .....	24
6.4.6 SETUP INDICATORS (Rate) .....	25
6.4.7 SETUP INDICATORS (Temperature) .....	25
6.4.8 SETUP FLOW INPUT (Pulse - Ain & PS (A=B)) .....	26
6.4.9 SETUP FLOW INPUT (Pulse - Quadrature, Qx1 or Qx2) .....	27
6.4.10 SETUP FLOW INPUT (Analog) .....	28
6.4.11 SETUP AUX INPUT .....	29
6.4.12 SET FLUID PROPERTIES .....	30
6.4.13 SETUP PULSE OUTPUT .....	30
6.4.14 SETUP ANALOG OUTPUT .....	31
6.4.15 SETUP RELAYS .....	31
6.4.16 SETUP CONTROL INPUTS(RATE/TOTAL) .....	33
6.4.17 SETUP CONTROL INPUTS(BATCH) .....	33
6.4.18 SETUP REALTIME CLOCK(Time) .....	34
6.4.19 SETUP REALTIME CLOCK(Date) .....	34
6.4.20 SERIAL USAGE .....	35
6.4.21 SET DATALOG/PRINT(Configure) .....	36
6.4.22 SET DATALOG/PRINT (Select_list) .....	37
6.4.23 ADMINISTRATIVE SETUP .....	37
6.4.24 SETUP NETWORK CARD .....	38

## 7. PRINCIPLE OF OPERATION

7.1 General .....	39
7.2 Orifice Flowmeter Considerations .....	39
7.3 Flow Equations .....	39
7.4 Calculating the Expansion Factor .....	42
7.5 Computation of Viscosity Coef. A and B .....	43
7.6 Linearization Table .....	44
7.6.1 Linearization Table General Information .....	44
7.6.2 Linearization Table for Pulse Inputs .....	44
7.6.3 Linearization Table for Analog Inputs .....	44
7.6.4 Linearization Table Interpolation .....	44

# CONTENTS

## 8. TEST, SERVICE and MAINTENANCE

8.1 Test Menus .....	45
8.2 Test Sub-Menus.....	46
8.2.1 Audit Trail.....	46
8.2.2 Error History .....	46
8.2.3 Print System Setup.....	46
8.2.4 Keypad test.....	47
8.2.5 Display test .....	47
8.2.6 Calibrate CH1 0mA.....	48
8.2.7 Calibrate CH1 20mA.....	48
8.2.8 Calibrate CH2 0mA.....	49
8.2.9 Calibrate CH2 20mA.....	49
8.2.10 Calibrate CH1 0V.....	50
8.2.11 Calibrate CH1 10V.....	50
8.2.12 Calibrate CH2 0V.....	51
8.2.13 Calibrate CH2 10V.....	51
8.2.14 Calibrate 100 ohm RTD.....	51
8.2.15 Calibrate 4mA Out .....	52
8.2.16 Calibrate 20mA Out .....	52
8.2.17 Analog In Test .....	52
8.2.18 Pulse input test.....	53
8.2.19 Analog out test.....	53
8.2.20 Excitation out test .....	53
8.2.21 Pulse out test.....	54
8.2.22 Relay test.....	54
8.2.23 Control input test .....	54
8.2.24 Battery Voltage test .....	55
8.2.25 Data logger utility .....	55
8.3 Internal Fuse Replacement .....	56

## 9. RS-232 SERIAL PORT

9.1 RS-232 Serial Port Description.....	57
9.2 Instrument Setup by PC Over Serial Port .....	57
9.3 Operation of Serial Communication Port with Printers .....	57
9.4 Flow Computer RS-232 Port Pinout .....	57

## 10. RS-485 SERIAL PORT

10.1 RS-485 Serial Port Description.....	58
10.2 General .....	58
10.3 Operation of Serial Communication Port with PC.....	58
10.4 Flow Computer RS-485 Port Pinout .....	58

## 11. FLOW COMPUTER SETUP SOFTWARE

11.1 System Requirements .....	59
11.2 Cable and Wiring Requirements.....	59
11.3 Installation for Windows™3.1 or 3.11 .....	59
11.4 Using the Flow Computer Setup Software.....	60
11.5 File Tab .....	60
11.6 Setup Tab.....	60
11.7 View Tab .....	61
11.8 Misc. Tab.....	61

## 12. GLOSSARY OF TERMS

12 Glossary Of Terms.....	62
---------------------------	----

## 13. DIAGNOSIS AND TROUBLESHOOTING

13.1 Response of Flow Computer on Error or Alarm:.....	66
13.2 Diagnosis Flow Chart and Troubleshooting.....	67
13.3 Error & Warning Messages: .....	68
13.3.1 Sensor/Process Alarms .....	68
13.3.2 Self Test Alarms .....	69

<b>APPENDIX A - Setup Menus .....</b>	<b>70</b>
---------------------------------------	-----------

<b>APPENDIX B - Batching Diagrams .....</b>	<b>71</b>
---	-----------

**Unit Description****1. Description****1.1 Unit Description:**

The SUPERtrol-I Flow Computer satisfies the instrument requirements for a variety of flowmeter types in liquid applications. Multiple flow equations and instrument functions are available in a single unit with many advanced features.

The alphanumeric display shows measured and calculated parameters in easy to understand format. Single key direct access to measurements and display scrolling is supported.

The versatility of the SUPERtrol-I permits a wide range of measurements within the instrument package. The various hardware inputs and outputs can be “soft” assigned to meet a variety of common application needs. The user “soft selects” the usage of each input/output while configuring the instrument. Consider the following illustrative examples.

The isolated analog output can be chosen to follow volume flow, corrected volume flow, mass flow, temperature, or density by means of a menu selection. Most hardware features are assignable by this method.

The user can assign the standard RS-232 Serial Port for data logging, transaction printing, or for connection to a modem for remote meter reading.

**Unit Features****1.2 Unit Features:**

The SUPERtrol-I Flow Computer offers the following features:

- Rate/Total and Batching Functions
- Advanced Batching Features: Overrun Compensation, Print End of Batch, Slow Start of Batch Fill, Slow End of Batch Fill, 2 Stage Batching or Digital Control Valve
- Advanced Printing Capabilities
- “EZ Setup” Guided Setup for First Time Users
- Menu Selectable Hardware & Software Features
- Isolated Pulse, Analog and Relay Outputs Standard on AC Powered Models
- RS-232 Port Standard, Modbus RTU RS-485 Optional
- Windows™ Setup Software
- On Board Data Logging
- DDE Server & HMI Software Available
- User Definable Units of Measure
- Enhanced Modem Features for Remote Metering

### 1.3 Specifications:

#### Specifications:

##### Environmental

Indoor Use  
 Altitude up to 2000m  
 Operating Temperature: 0°C to +50°C  
 (-20°C to 55°C optional)  
 Storage Temperature: -40°C to +85 C  
 Maximum Relative Humidity : 80% for temperatures up to 31°C decreasing linearly to 50% RH at 40°C  
 Mains supply voltage fluctuations not to exceed ±10% of the nominal voltage  
 Transient overvoltage according to INSTALLATION CATEGORY II (see UL 3101-1 Annex J)  
 POLLUTION DEGREE 2 in accordance with IEC 664 (see 3.7.3)  
 Materials: UL, CSA, VDE approved  
 UL= UL Class 1 Division 2

**Approvals:** CE Approved Light Industrial,  
 UL File #: E192404 / CUL

##### Display

Type: 2 lines of 20 characters  
 Types: Backlit LCD, OLED or VFD ordering options  
 Character Size: 0.2" nominal  
 User selectable label descriptors and units of measure

##### Keypad

Keypad Type: Membrane Keypad  
 Keypad Rating: Sealed to Nema 4  
 Number of keys: 16

##### Enclosure

Size: See Dimensions  
 Seal: NEMA4X  
 Materials: Aluminum

##### Power Input

The factory equipped power option is internally fused. An internal line to line filter capacitor is provided for added transient suppression.  
 Order Option 1: 110VAC: 85 to 127 Vrms, 50/60Hz  
 Order Option 2: 220VAC: 170 to 276 Vrms, 50/60Hz  
 Order Option 3: 12VDC: 10.5 to 14 VDC  
 Order Option 4: 24VDC: 18 to 24 VDC

##### Flow Inputs:

##### Analog Input:

Ranges  
 Voltage: 0-10 VDC, 0-5 VDC, 1-5 VDC  
 Current: 4-20 mA, 0-20 mA  
 Basic Measurement Resolution: 16 bit  
 Update Rate: 5 updates/sec minimum  
 Automatic Fault detection: Signal over/under-range,  
 Current Loop Broken  
 Calibration: Self Calibration and Auto-zero Continuously  
 Extended calibration: Learns Zero and Full Scale of each range using special test mode.  
 Fault Protection:  
 Fast Transient: 500 V Protection (Capacitive Clamp)  
 Reverse Polarity: No ill effects  
 Over-Voltage Limit: 50 VDC Over voltage protection  
 Over-Current Protection: Internally current limited Protected to 24 VDC.

##### Pulse Inputs:

Number of Flow Inputs: one  
 Configurations supported: single input with or without quadrature (menu selectable)  
 Input Impedance: 10 KΩ nominal  
 Pullup Resistance: 10 KΩ to 5 VDC (menu selectable)  
 Pull Down Resistance: 10 KΩ to common  
 Trigger Level: (menu selectable)  
 High Level Input  
 Logic On: 3 to 30 VDC  
 Logic Off: 0 to 1 VDC  
 Low Level Input (mag pickup)  
 Selectable sensitivity: 10 mV & 100 mV  
 Minimum Count Speed: User selectable  
 Maximum Count Speed: Selectable: 0 to 20kHz  
 Overvoltage Protection: 50 VDC  
 Fast Transient: Protected to 500 VDC (Capacitive Clamp)

##### Compensation Input

The compensation input is menu selectable for temperature, density or not used.

Operation: Ratiometric  
 Accuracy: 0.02% FS  
 Thermal Drift: Less than 100 ppm/C  
 Basic Measurement Resolution: 16 bit  
 Update Rate: 1 update/sec minimum  
 Automatic Fault detection:  
 Signal Over-range/under-range  
 Current Loop Broken  
 RTD short  
 RTD open  
 Fault mode to user defined default settings  
  
 Transient Protection: 500 V (Capacitive Clamp)  
 Reverse Polarity: No ill effects  
 Over-Voltage Limit (Voltage Input): 50 VDC

##### Available Input Ranges

Voltage: 0-10 VDC, 0-5 VDC, 1-5 VDC  
 Current: 4-20 mA, 0-20 mA  
 Resistance: 100 Ohms DIN RTD

##### 100 Ohm DIN RTD (DIN 42-760, BS 1904):

Three Wire Lead Compensation  
 Internal RTD linearization learns ice point resistance  
 1 mA Excitation current with reverse polarity protection  
 Temperature Resolution: 0.01 C

##### Control Inputs

Switch Inputs are menu selectable for Start, Stop, Reset, Lock, Inhibit, Alarm Acknowledge, Print or Not Used.  
 Control Input Specifications  
 Input Scan Rate: 10 scans per second  
 Logic 1: 4 - 30 VDC  
 Logic 0: 0 - 0.8 VDC  
 Transient Suppression: 500 V fast transient (Capacitive Clamp)  
 Input Impedance: 100 KΩ  
 Control Activation: Positive Edge or Pos. Level based on product definition

##### Excitation Voltage

110/220 VAC Powered Units  
 Menu Selectable: 5, 12 or 24 VDC @ 100mA  
 24 VDC Powered Units  
 Menu Selectable: 5 or 12 VDC @ 100mA  
 12 VDC Powered Units  
 5 VDC @ 100mA

### Relay Outputs

The relay outputs are menu assignable to (Individually for each relay) Low Rate Alarm, Hi Rate Alarm, Prewarn Alarm, Preset Alarm or General purpose warning (security).

Number of relays: 2 (4 optional)  
 Contact Style: Form C contacts  
 Contact Ratings: 2400 VAC Max., 3 Amps Max.  
 Fast Transient Threshold: 1000 V

### Serial Communication

The serial port can be used for printing, datalogging, modem connection and communication with a computer.

#### RS-232:

Device ID: 01-99  
 Baud Rates: 300, 600, 1200, 2400, 4800, 9600, 19200

Parity: None, Odd, Even

Handshaking: None, Software, Hardware

Print Setup: Configurable print list and formatting

#### RS-485:

Device ID: 01-247  
 Baud Rates: 1200, 2400, 4800, 9600, 19200  
 Parity: None, Odd, Even

Protocol: Modbus RTU (Half Duplex)

### Analog Output

The analog output is menu assignable to correspond to the Uncompensated Volume Rate, Corrected Volume Rate, Mass Rate, Temperature, Density, Volume Total, Corrected Volume Total or Mass Total. Type: Isolated Current Sourcing (AC power options)

Isolated I/P/C: 500 V

Available Ranges: 4-20 mA, 0-20 mA

Resolution: 12 bit

Accuracy: 0.05% FS at 20 Degrees C

Update Rate: 1 update/sec minimum

Temperature Drift: Less than 200 ppm/C

Maximum Load: 1000 ohms (at nominal line voltage)

Compliance Effect: Less than .05% Span

60 Hz rejection: 40 dB minimum

EMI: No effect at 3 V/M

Calibration: Operator assisted Learn Mode

Averaging: User entry of DSP Averaging constant to cause a smooth control action.

### Isolated Pulse output

The isolated pulse output is menu assignable to Uncompensated Volume Total, Compensated Volume Total or Mass Total.

Isolation I/O/P: 500 V

Pulse Output Form: Open Collector

Maximum On Current: 125 mA

Maximum Off Voltage: 30 VDC

Saturation Voltage: 1.0 VDC

Maximum Off Current: 0.1 mA

Pulse Duration: User selectable

Pulse output buffer: 8 bit

Fault Protection

Reverse polarity: Shunt Diode

Transient Protection: 500 VDC  
 (Capacitive Clamp)

### Operating Mode

The Flow Computer can be thought of as making a series of measurements of flow, temperature/density sensors and then performing calculations to arrive at a result(s) which is then updated periodically on the display. The analog output, the pulse output, and the alarm relays are also updated. The cycle then repeats itself.

Step 1: Update the measurements of input signals-

Raw Input Measurements are made at each input using equations based on input signal type selected. The system notes the "out of range" input signal as an alarm condition.

Step 2: Compute the Flowing Fluid Parameters-

The temperature, viscosity, and density equations are computed as needed based on the flow equation and input usage selected by the user.

Step 3 : Compute the Volumetric Flow-

Uncompensated flow is the term given to the flow in volume units. The value is computed based on the flowmeter input type selected and augmented by any performance enhancing linearization that has been specified by the user.

Step 4: Compute the Corrected Volume Flow at Reference Conditions-

In the case of a corrected liquid volume flow calculation, the corrected volume flow is computed as required by the selected compensation equation.

Step 5 : Compute the Mass Flow-

All required information is now available to compute the mass flow rate as volume flow times density.

Step 6: Check Flow Alarms-

The flow alarm functions have been assigned to one of the above flow rates during the setup of the instrument. A comparison is now made by comparing the current flow rates against the specified hi and low limits.

Step 7: Compute the Analog Output-

This designated flow rate value is now used to compute the analog output.

Step 8: Compute the Flow Totals by Summation-

A flow total increment is computed for each flow rate. This increment is computed by multiplying the respective flow rate by a time base scaler and then summing. The totalizer format also includes provisions for total rollover.

Step 9: Total Preset Comparisons-

The total associated with a preset function is then compared against the corresponding preset value and any required control actions taken.

Step 10: Pulse Output Service-

The pulse output is next updated by scaling the total increment which has just been determined by the pulse output scaler and summing it to any residual pulse output amount.

Step 11: Update Display and Printer Output-

The instrument finally runs a task to update the various table entries associated with the front panel display and serial outputs.

### Setup Mode

The setup mode is password protected by means of a numeric lock out code established by the user. In addition, a secret, manufacturers numeric unlock entry sequence is available.

The system also provides a minimum implementation of an "audit trail" which tracks significant setup changes to the unit. This feature is increasingly being found of benefit to users or simply required by Weights and Measurement Officials in systems used in commerce, trade, or "custody transfer" applications.

A software program is available which runs on a PC using a RS-232 Serial for connection to the Flow Computer. Illustrative examples may be down loaded in this manner.

The setup mode has numerous subgrouping of parameters needed for flow calculations. There is a well conceived hierarchy to the setup parameter list. Selections made at the beginning of the setup affect offerings further down in the lists.

In the setup mode, the flow computer activates the correct setup variables based on the instrument configuration, the flow equation, and the hardware selections made for the compensation transmitter type, the flow transmitter type, and meter enhancements (linearization) options selected. All required setup parameters are enabled. All setup parameters not required are suppressed.

A help line prompt is provided for each entry. In addition a help message is available which may be accessed by depressing the "HELP" key.

In the setup mode selections, several parameters are required to be input by the operator since these parameters are blank when the unit is received. The user will be prompted for these necessary values for his application.

Also note that in the setup mode are parameter selections which have preassigned industry standard values. The unit will assume these values unless they are modified by the user.

Most of the process input variables have available a "default" or emergency value which must be entered. These are the values that the unit assumes when a malfunction is determined to have occurred on the corresponding input.

It is possible to enter in a nominal constant value for temperature or density, or analog flow inputs by placing the desired nominal value into both the lo and hi values. This is also a convenience when performing bench top tests without simulators.

### Maintenance Mode:

The Maintenance Mode of the Flow Computer is the Test and Calibration Mode for the device. This mode provides a number of specialized utilities required for factory calibration, instrument checkout on start-up, and periodic calibration documentation.

A password is required to gain access to this specialized mode of operation. Normally quality, calibration, and maintenance personnel will find this mode of operation very useful. It is also useful for factory testing.

Many of these tests may be used during start-up of a new system. Inputs signals may be read, and output signals may be exercised to verify the electrical interconnects before the entire system is put on line.

The following action items may be performed in the Maintenance Mode:

- Print Calibration/Maintenance Report
- Examine Audit Trail
- Perform Keypad Checkout
- Perform Display Checkout
- Perform Pulse Input Checkout
- Perform Pulse Output Checkout
- Perform Control Input Checkout
- Perform Relay Output Checkout
- Perform Analog Input Checkout
- Perform Analog Output Checkout
- Calibrate Analog Inputs using the Learn Feature
- Calibrate Analog Output using the Learn Feature
- Battery Check

Note that a calibration of the analog input/output will advance the audit trail counters since it effects the accuracy of the system.

### RS-232 Serial Port

The Flow Computer has a general purpose RS-232 Port which may be used for any one of the following purposes:

- Transaction Printing
- Data Logging Internal Datalog Dumps
- Remote Metering by Modem (optional)
- Computer Communication Link
- Configuration by Computer
- Print System Setup
- Print Calibration/Malfunction History
- Remote Control

### Instrument Setup by PC's over Serial Port

A Diskette program is provided with the Flow Computer that enables the user to rapidly configure the Flow Computer using an Personnel Computer. Included on the diskette are common instrument applications which may be used as a starting point for your application. This permits the user to have an excellent starting point and helps speed the user through the instrument setup.



### Operation of Serial Communication Port with Printers

Flow Computer's RS-232 channel supports a number of operating modes. One of these modes is intended to support operation with a printer in metering applications requiring transaction printing, data logging and/or printing of calibration and maintenance reports.

For transaction printing, the user defines the items to be included in the printed document. The user can also select what initiates the transaction print generated as part of the setup of the instrument. The transaction document may be initiated via a front panel key depression, a remote contact closure, or upon completion of a batch.

In data logging, the user defines the items to be included in each data log as a print list. The user can also select when or how often he wishes a data log to be made. This is done during the setup of the instrument as either a time of day or as a time interval between logging.

The system setup and maintenance report lists all the instrument setup parameters and usage for the current instrument configuration. In addition, the Audit trail information is presented along with a status report listing any observed malfunctions which have not been corrected.

The user initiates the printing of this report at a designated point in the menu by pressing the print key on the front panel.

### Operation of Serial Port with Modems (optional)

The Flow Computer RS-232 channel supports a number of operating modes. One of these modes is intended to support operation with a modem in remote metering applications.

An external modem is intentionally being used with the Flow Computer. This permits use with the variety of modem standards worldwide while avoiding the specialized approvals required for equipment that is deemed to fall under the category of telecommunication equipment.

In the modem mode, the Flow Computer is assumed to be operating in a remote metering role. The Flow Computer will support key items in the Hayes Compatible "AT" Command Set. In this role, the Flow Computer will have the following special abilities:

0. Monitor the modem status as a task of the system
1. Instruct the modem to answer an incoming call ATA
2. Respond to the calling modem at a compatible baud rate and protocol
3. Perform error checking in conjunction with the modem
4. Monitor the status of the carrier
5. Terminate the telephone connection in event the connection is lost.

In addition, the Flow Computer will be capable of initiating a call to a designed telephone number in the event of a metering malfunction.

## 2. Installation

### General Mounting Hints

#### 2.1 General Mounting Hints:

The SUPERtrol-I Flow Computer should be located in an area with a clean, dry atmosphere which is relatively free of shock and vibration. The unit is installed in a 5.43" (138mm) wide by 2.68" (68mm) high panel cutout. (see Mounting Dimensions) To mount the Flow Computer, proceed as follows:

### Mounting Procedure

- Prepare the panel opening.
- Slide the unit through the panel cutout until it touches the panel.
- Install the screws (provided) in the mounting bracket and slip the bracket over the rear of the case until it snaps in place.
- Tighten the screws firmly to attach the bezel to the panel. 3 in. lb. of torque must be applied and the bezel must be parallel to the panel.

#### Termination Connectors:

Minimum Wire Gauge: 22 AWG

Maximum Wire Gauge: 14 AWG

Voltage/current limits are limited by unit specifications.

#### Permanently Connected Equipment:

##### UL 3101-1, Section 6.12.2.1 specifies that:

- A switch or circuit breaker shall be included in the building installation;
- It shall be in close proximity to the equipment and within easy reach of the OPERATOR;
- It shall be marked as the disconnecting device for the equipment.

Ensure that the switch or circuit breaker chosen is suitable for the power requirements of the unit.

#### 2.2 Mounting Diagrams:

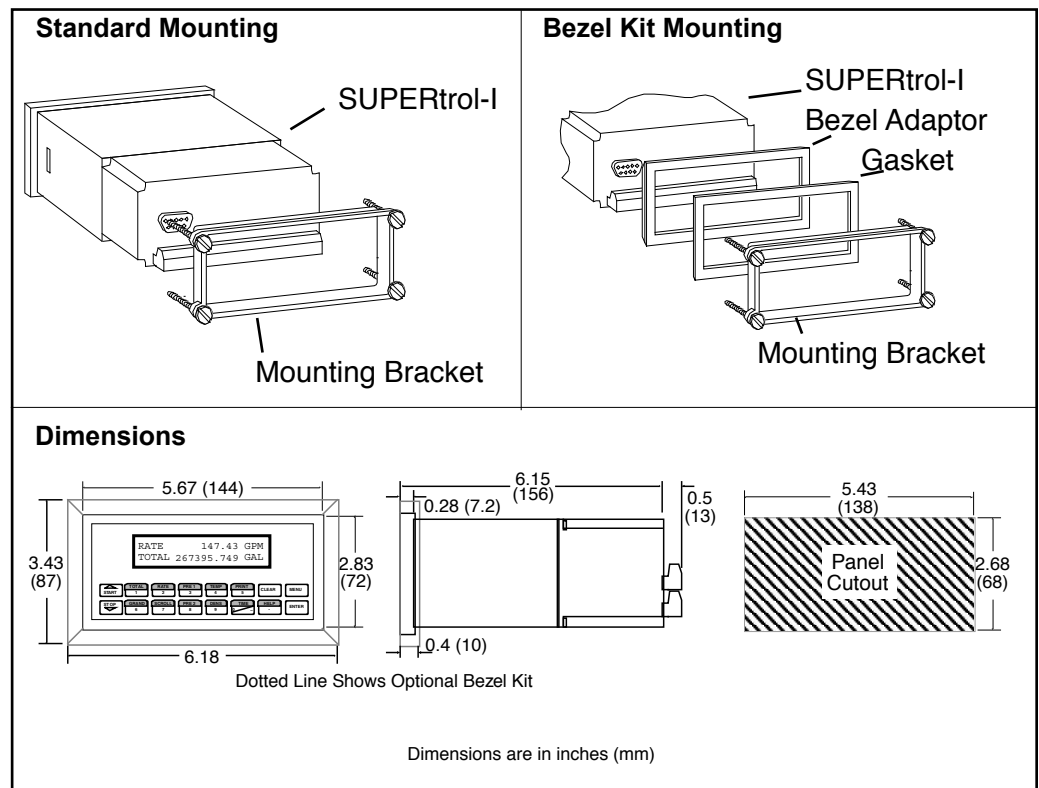

### 3. Applications

#### Liquid Volume

#### 3.1 Liquid Volume

**Measurements:**

A flowmeter measures the actual volume in a liquid line. A temperature sensor can also be installed to correct for liquid thermal expansion (see 3.2 Corrected Volume).

**Calculations:**

- For Flowmeters with Pulse Outputs, Volume flow is calculated using the flowmeter frequency output and the user entered K-Factor.
- For Flowmeters with Analog Transmitters, Volume flow is calculated using the measured flowmeter signal and the user entered scale settings.

**Output Results:**

- Display Results
  - Flow Rate, Resettable Total, Non-Resettable Total
- Analog Output
  - Rate or Total
- Pulse Output
  - Total
- Relay Outputs
  - Rate or Total Alarms

**Applications:**

The Flow Computer can monitor actual volume flow and total of any liquid. Flow alarms are provided via relays and datalogging is available via analog (4-20mA) and serial outputs.

#### Liquid Volume Illustration

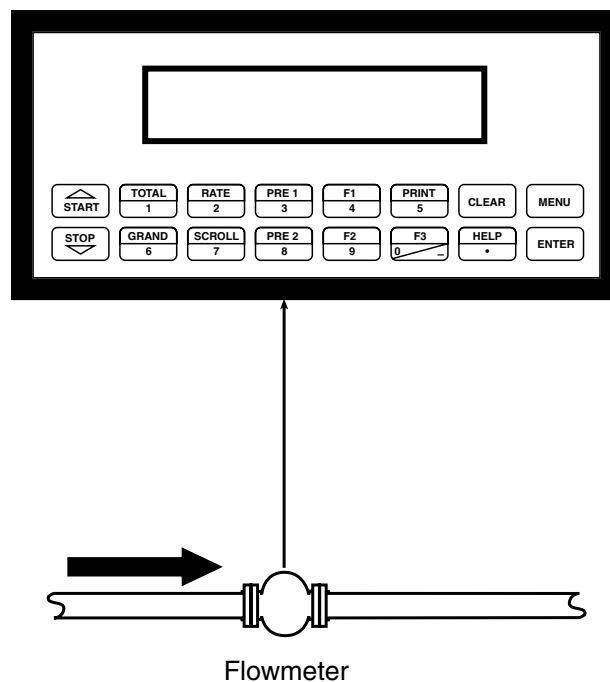

#### Calculations

Pulse Input; Average K-Factor

$$\text{Volume Flow} = \frac{\text{input frequency} * \text{time scale factor}}{\text{K-Factor}}$$

Analog Input; Linear

$$\text{Volume Flow} = \% \text{ input} * \text{Full Scale Flow}$$

## Corrected Liquid Volume

### 3.2 Corrected Liquid Volume

#### Measurements:

A flowmeter measures the actual volume in a liquid line. A temperature sensor is installed to correct for liquid thermal expansion.

#### Calculations:

- Corrected Volume is calculated using the flow and temperature inputs as well as the thermal expansion coefficient stored in the flow computer. Use the "SET FLUID PROPERTIES" submenu to define reference temperature and density values for standard conditions.

#### Output Results:

- Display Results  
Flow Rate, Resettable Total, Non-Resettable Total, Temperature, Density
- Analog Output  
Rate, Total, Temperature or Density
- Pulse Output  
Total
- Relay Outputs  
Rate, Total or Temperature Alarms

#### Applications:

Monitoring corrected volume flow and total of any liquid. Flow alarms are provided via relays and datalogging is available via analog (4-20mA) and serial outputs.

## Corrected Liquid Volume Illustration

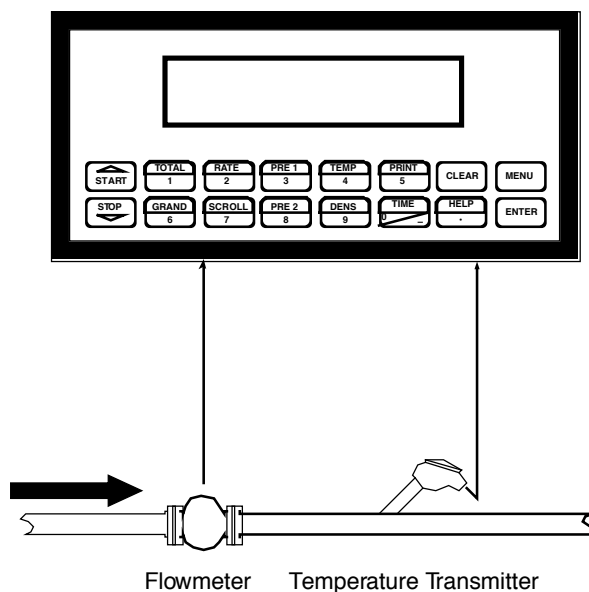

## Calculations

### Volume Flow

As calculated in section 3.1

### Corrected Volume Flow (Temp. Transmitter)

$$\text{Corrected Volume Flow} = \text{vol. flow} * (1 - \text{Therm.Exp.Coef.} * (T_f - T_{ref}))^2$$

**Liquid Mass**

**3.3 Liquid Mass**

**Measurements:**

Actual volume is measured by the flow element (DP transmitter, Flowmeter). Temperature is measured by the temperature transmitter. A density transmitter can be used for direct density measurements.

**Calculations:**

- The density and mass flow are calculated using the reference density and the thermal expansion coefficient of the liquid (see "SET FLUID PROPERTIES" submenu)

**Output Results:**

- Display Results  
Flow Rate, Resettable Total, Non-Resettable Total, Temperature, Density
- Analog Output  
Rate, Total, Temperature or Density
- Pulse Output  
Total
- Relay Outputs  
Rate, Total or Temperature Alarms

**Applications:**

Monitoring mass flow and total of any liquid. Flow alarms are provided via relays and datalogging is available via analog (4-20mA) and serial outputs.

**Liquid Mass Illustration**

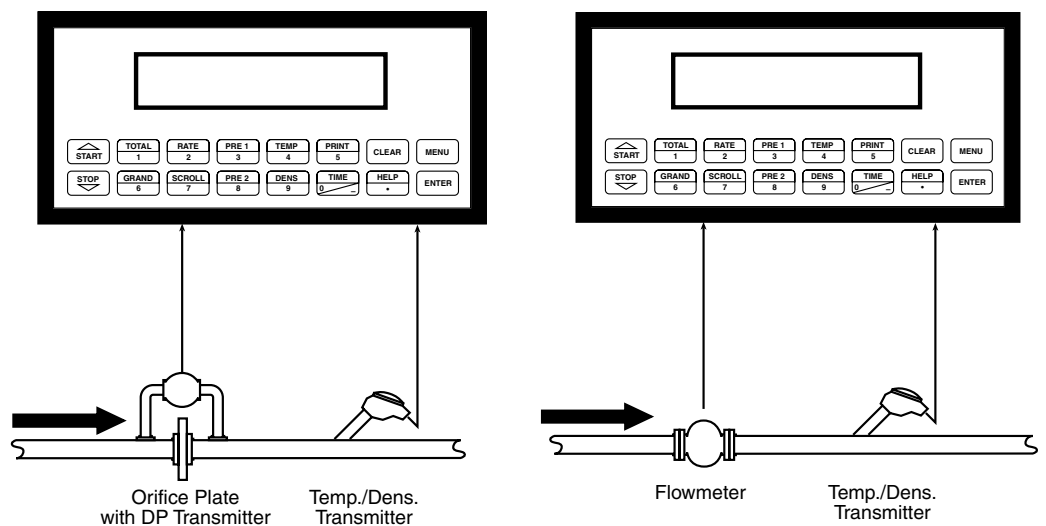

**Calculations**

Volume Flow

As calculated in section 3.1

Mass Flow

Mass Flow = volume flow \* density

**Batching**

**3.4 Batching**

**Measurements:**

A flowmeter measures the actual volume in a liquid line. A temperature sensor can also be installed to correct for liquid thermal expansion (see 3.2 Corrected Volume).

**Calculations:**

- For Flowmeters with Pulse Outputs, Volume flow is calculated using the flowmeter frequency output and the user entered K-Factor.
- For Flowmeters with Analog Transmitters, Volume flow is calculated using the measured flowmeter signal and the user entered scale settings.
- Corrected Volume is calculated using the flow and temperature inputs as well as the thermal expansion coefficient stored in the flow computer.

**Output Results:**

- Display Results  
Flow Rate, Batch Total, Non-Resettable Total, Temperature, Density
- Analog Output  
Rate, Total, Temperature or Density
- Pulse Output  
Total
- Relay Outputs  
Batch Total, Rate, or Temperature Alarms

**Applications:**

Batching and monitoring flow and total of any liquid. Batching is accomplished via relays and datalogging is available via analog (4-20mA) and serial outputs.

**Batching Illustration**

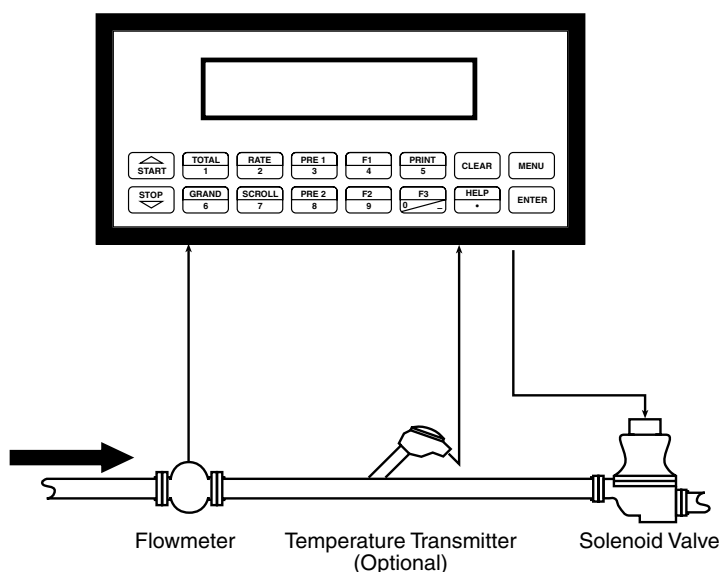

**Calculations**

Volume Flow

As calculated in section 3.1

Corrected Volume Flow (Temp. Transmitter)

$$\text{Corrected Vol. Flow} = \text{volume flow} * (1 - \text{Therm.Exp.Coef.} * (\text{Tf} - \text{Tref}))^2$$

### 4 WIRING

#### Batcher Wiring

#### 4.1 Typical Batcher Wiring:

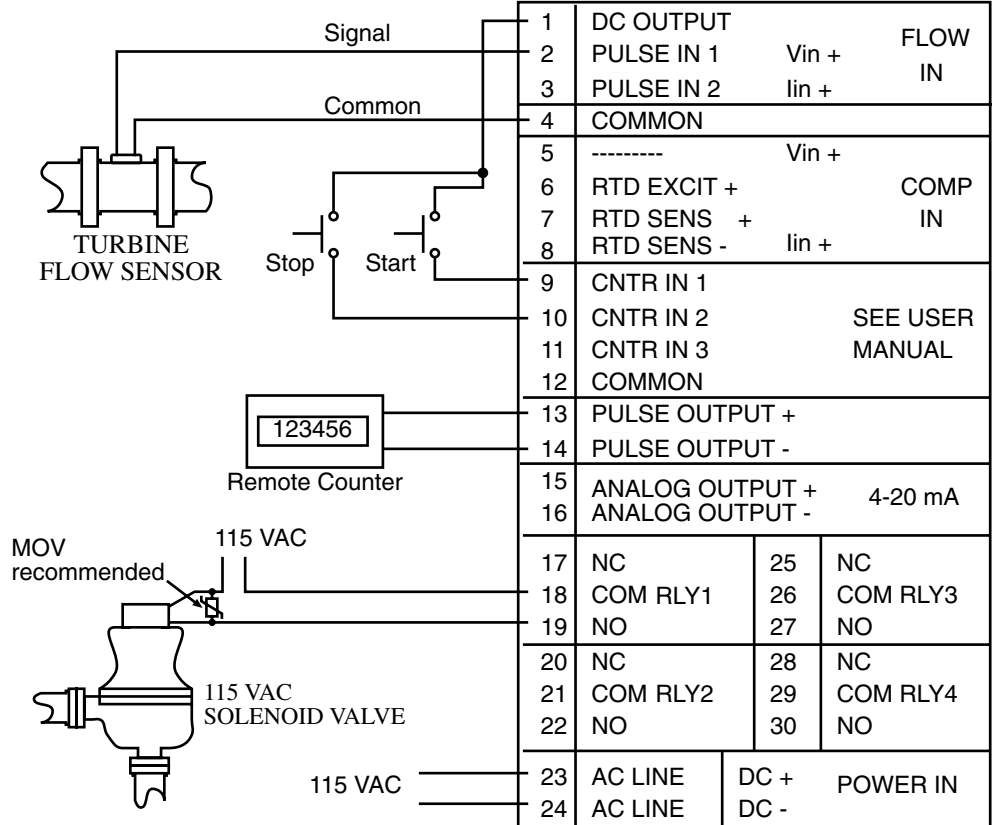
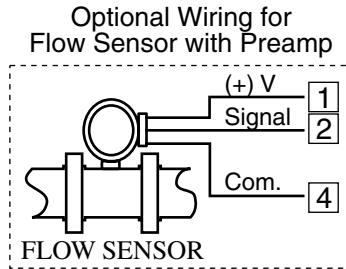

#### Rate / Total Wiring

#### 4.2 Typical Rate/Total Wiring:

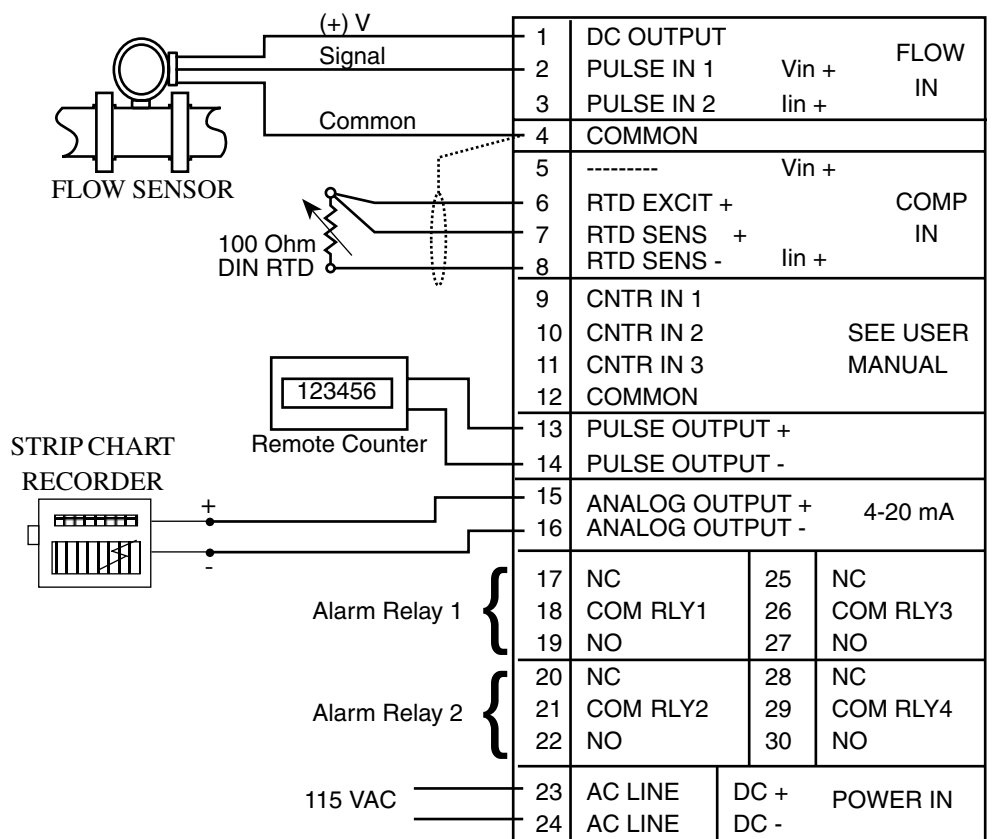

**4.3 Wiring In Hazardous Areas:**

**Examples using MLT787S+ Barrier (MTL4755ac for RTD)**

**Flow Input**

**Flow Input**

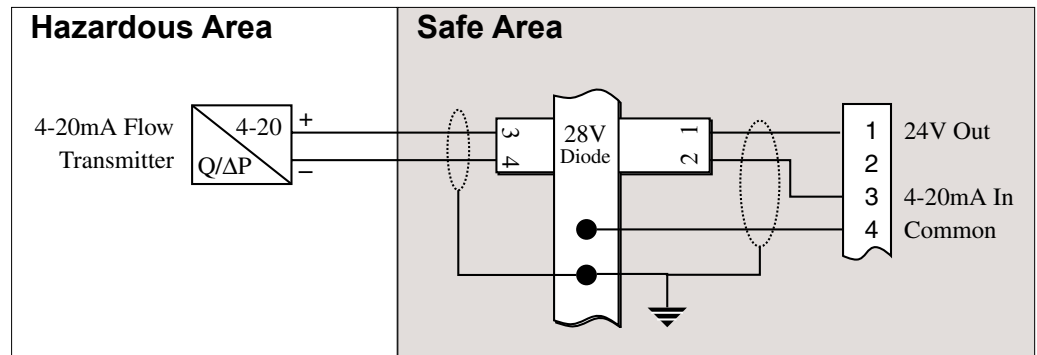

**Temperature Input (4-20mA Transmitter)**

**Temperature Input (4-20mA Transmitter)**

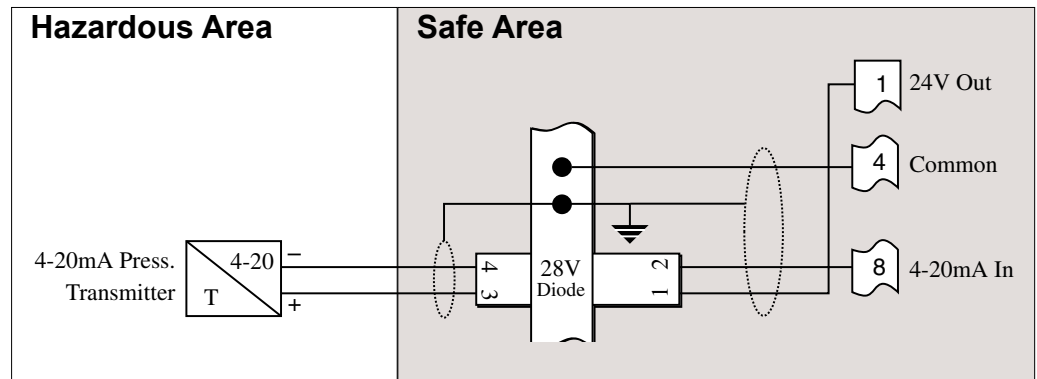

**Temperature Input (RTD)**

**Temperature Input (RTD)**

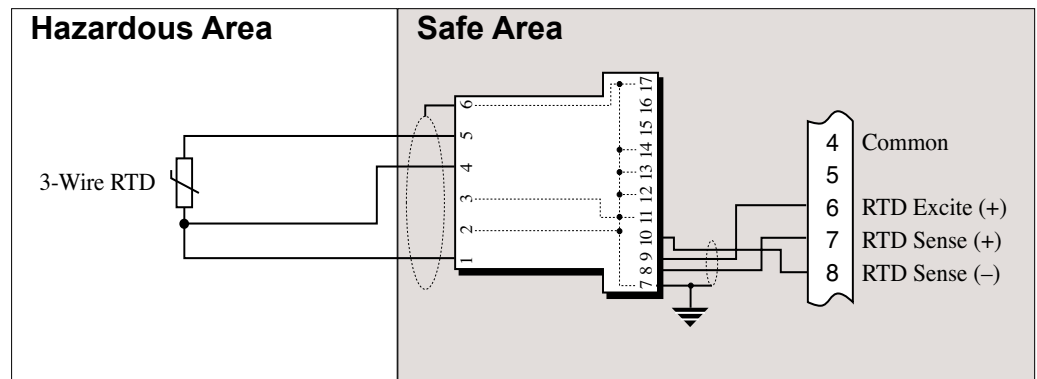



## 5. UNIT OPERATION

### 5.1 Front Panel Operation Concept for Run Mode

The Flow Computer is fully programmable through the front panel. Please review the following usage summary before attempting to use the instrument.

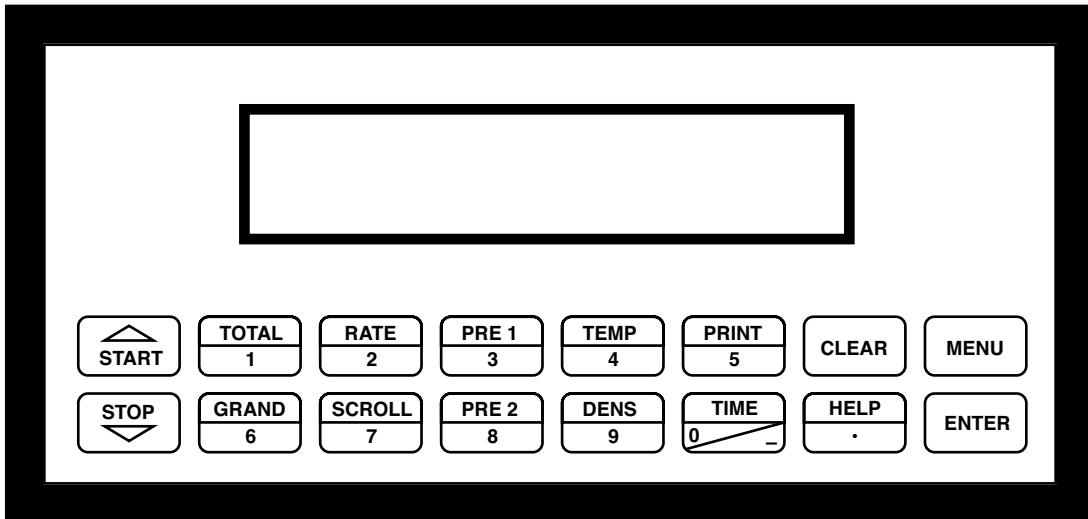

#### HELP

On-line help is provided to assist the operator in using this product. The help is available during RUN and SETUP modes simply by pressing the HELP key. The HELP key is used to enter decimals when entering numeric values.

#### FUNCTION KEYS

In the RUN mode, several keys have a special, direct access feature, to display an item of interest (i.e. RATE, TOTAL, PRE 1, etc.). Press the key to view your choice. Press the SCROLL key to return to scrolling display.

#### CLEARING TOTALIZER

To clear the total, you must press the TOTAL Function Key 3 times. You will be asked to verify this action. The operator will be prompted to enter password if the unit is locked.

NOTE: In the Batcher Mode, simply press the CLEAR key to reset the total (the batcher must be stopped or finished batching). It is not necessary to press the TOTAL Function Key first.

#### CLEARING GRAND TOTAL

To clear the grand total, you must press the GRAND Function Key 3 times. You will be asked to verify this action. The supervisor will be prompted to enter the supervisor password if the unit is locked.

#### PRESET KEYS USING EZ PRESET

In the RUN mode, PRE 1 & PRE 2 keys are used to view and/or change the preset setpoints. To view the Presets, simply press the desired Preset key. Press Enter then press the Clear key for direct editing of the preset setpoints.

#### PRESET KEYS

In the RUN mode, PRE 1 & PRE 2 keys are used to view and/or change the preset setpoints. To view the Presets, simply press the desired Preset key. Rapidly press the Preset keys 3 times, then press the Clear key for direct editing of the preset setpoints. Press Enter or Start to complete the Preset entry.

#### SCROLL

Rapidly press the Scroll key three times to setup a display list.

Press the CLEAR key to remove old scroll list.

Press the function key for the item you wish to add

Use the  $\Delta$   $\nabla$  keys to assign the line.

#### PRINT

The PRINT key is used to print on demand. When the PRINT key is pressed, a user defined list of data (TOTAL, RATE, PRE 1, etc.) is sent to the RS-232 port. A timed message of "PRINTING" will be displayed to acknowledge the print request.

#### SPECIAL BATCHING KEYS

The START and STOP keys are used only when batching to start and stop batches. The CLEAR key will clear the total without first pressing the TOTAL key (unit must be stopped). All other keys work the same in both Rate/Total mode and Batch mode. The Start and Stop keys operation are set by the control input settings. The Start options are: START or RESET/START. The Stop options are: STOP or STOP/RESET.

#### MENU KEY

The MENU key is used to enter the Setup and Test modes. Press the MENU key to enter the Setup and Test modes. (See section 6 for Setup mode, section 8 for Test mode). The MENU key is used as "escape" in Setup and Test Programming. Pressing the MENU key while programming in the Sub-Menu groups will backup the display to that Sub-Menu group heading. Pressing the MENU key while viewing the Sub-Menu groups will backup the display to the Top Level Menu.

#### ACKNOWLEDGING ALARMS

Most alarm messages are self-clearing. Press the ENTER key to acknowledge and clear alarms.

NOTE: Some keys and functions are password protected. Enter the password to gain access. The passwords are factory set as follows: Operator = 0 Supervisor = 2000

**General  
Operation****5.2 General Operation**

The unit can display: Rate, Total, Grand Total, Temperature, Density, Presets and Time of Day. The Temperature and/or Density can be displayed even if you are using the Volumetric Flow Equation (a Temperature or Density sensor must be installed). The unit can perform Mass or Corrected Volume equations using a temperature or density sensor (these equations can be computed without Temp/Dens sensors by using user defined default values). The unit can be programmed to perform Ratemeter/Totalizer or Batching functions (see section 6.3, SELECT INSTRUMENT Submenu).

**Rate/Total  
Operation****5.3 Ratemeter/Totalizer Operation**

The Ratemeter/Totalizer mode is used primarily to monitor flowrate and accumulated total. The relays can be used to trigger flow, total, temperature or density alarms.

**Password Protection  
(Rate/Total mode)****5.3.1 Password Protection for Rate/Total mode**

After an Operator and/or Supervisor Password is entered in the setup mode (see section 6.3, SETUP PASSWORD submenu), the unit will be locked. The unit will prompt the user for the password when trying to perform the following functions:

- Clear Total
- Clear Grand Total
- Enter Menu
- Edit Preset 1 (PRE 1 Key)
- Edit Preset 2 (PRE 2 Key)

The Supervisor password should be reserved for supervisors. The Supervisor password will allow access to restricted areas of the Setup and Test menus.

**Relay Operation  
(Rate/Total mode)****5.3.2 Relay Operation in Rate/Total mode**

Up to four relays are available (two standard) for alarm outputs. The relays can be assigned to trip according to rate, total, temperature, density readings or general system alarms. The relays can be programmed for low or high alarms. Preset 1 (RLY1) and Preset 2 (RLY2) are easily accessible by pressing the PRE 1 or PRE 2 key on the front panel. Preset 3 and Preset 4 are accessible only through the setup menu.

**Pulse Output  
(Rate/Total mode)****5.3.3 Pulse Output in Rate/Total mode**

The isolated pulse output (open collector) is menu assignable to Volume Total, Corrected Volume Total or Mass Total. The pulse output duration can be set for 10mS (50 Hz max) or 100mS (5 Hz max). A pulse output scale factor (pulse value) can be set to scale the pulse output. The pulse output is ideal for connecting to remote totalizers or other devices such as a PLC. See section 1.3 for electrical specifications.

**Analog Output  
(Rate/Total mode)****5.3.4 Analog Output in Rate/Total mode**

The analog output is menu assignable to correspond to the Volume Rate, Corrected Volume Rate, Mass Rate, Temperature, Density, Volume Total, Corrected Volume Total or Mass Total. The analog output is ideal for "trend" tracking using strip chart recorders or other devices.

### RS-232 Serial Port (Rate/Total mode)

#### 5.3.5 RS-232 Serial Port Operation in Rate/Total mode

The RS-232 serial port can be used for programming (using the Setup Disk) or for communicating to printers and computers in the Operating Mode (Run Mode).

##### **PC Communications:**

The Setup Disk also allows the user to query the unit for operating status such as Flow Rate, Flow Total, Temperature, Density, Presets, etc.

##### **Operation of RS-232 Serial Port with Printers:**

###### Transaction Printing

For transaction printing, the user defines the items to be included in the printed document (see section 6.3.20 SET DATA OUTPUT, Select\_list). The transaction document can be initiated by pressing the PRINT key or by a remote contact closure.

###### Data Logging

In data logging, the user defines the items to be included in each data log (see section 6.3.20 SET PRINTER OUTPUT, Select\_list). The user can also select when (time of day) or how often (print interval) the data log is to be made (see section 6.3.19 SET PRINTER OUTPUT, Configure).

###### System Setup and Maintenance Report

The system setup and maintenance report lists all of the instrument setup parameters and usage for the current instrument configuration. The audit trail information and a status report is also printed. This report is initiated in the Test menu (see section 8.2.3 PRINT SYSTEM SETUP).

### RS-485 Serial Port (Rate/Total mode)

#### 5.3.6 RS-485 Serial Port (optional)

##### **RS-485 Port Description:**

The optional RS-485 card utilizes Modbus RTU protocol to access a variety of process parameters and totalizers. The Relays can be controlled via Modbus. In addition, action routines can be executed. For further information, contact factory and request RS-485 Protocol manual.

##### **Operation of Serial Communication Port with PC**

The flow computer's RS-485 channel supports a number of Modbus RTU commands. Modbus RTU drivers are available from third party sources for a variety of Man Machine Interface software for IBM compatible PC's.

The user reads and writes information from/to the RS-485 using the Modbus RTU commands. The Flow Computer then responds to these information and command requests.

Process variables and totalizers are read in register pairs in floating point format. Time and date are read as a series of integer register values. Alarms are individually read as coils. Action routines are initiated by writing to coils.

## 5.4 Batcher Operation

The Batcher mode is used primarily to control batches. The main difference between the Batch mode and Rate/Total mode is the relay operation. The Batch mode allows the operator to "START" the unit via the front panel or remote input. Once started, the relays (RLY1 & RLY2) will energize and send power to a flow control device (i.e. solenoid valve or pump). The flow sensor will send a signal to the unit and total accumulation will begin. When the Prewarn value (PRE 2) is reached, Relay 2 will drop out (this is ideal for flow slow down). When the Batch amount (PRE 1) is reached, Relay 1 will drop out and the Batch is complete.

Refer to Appendix B for additional diagrams for Batching concepts for conventional two stage batching and/or batching with a Digital Control Valve.

Several messages will be displayed during normal batch operation (i.e. Batch Fill, Batch Stopped). The keypad is disabled for the duration of these timed messages (approx. 2 sec).

### Batcher Configuration

#### 5.4.1 Batcher Configuration.

When the unit is programmed for batch mode, several batch operation choices are available. These choices include: Up or Down Counting, Maximum Batch Preset, Batch Overrun Compensation, Auto Batch Restart, Time Delay, Flow Signal Timeout, Maximum Drain Time, Slow Start Quantity, Start or Reset/Start, and Stop or Stop/Reset.

##### **Standard Preset or EZ Preset**

Use Standard Preset for applications in which the batch amount does not change frequently.

Use EZ Preset in applications in which the batch amounts change frequently. The EZ Preset mode was designed to enter presets with minimum key strokes.

##### **Batch Count Mode**

The Batch Count Mode allows the user to choose whether the unit will batch up to a preset value or batch down from a preset value to zero.

##### **Maximum Batch Preset**

The Maximum Batch Preset allows the user to program the Maximum Batch value allowed to be entered by the operator. If an operator should try to program a batch higher than this value, the unit will not allow the value to be entered and will prompt the user with an error message saying that the Maximum Batch Preset has been exceeded.

##### **Batch Overrun**

The Batch Overrun is used for batch applications that have slow responding valves and a consistent batching flowrate. When the Batch Overrun is set, the unit will compensate for batch overruns by computing an averaged overrun value from the last four batches. This average is used to internally adjust the batch setpoint to minimize overrun.

##### **Flow Signal Timeout**

The Flow Signal Timeout allows the user to enter a timeout of 0 to 99 seconds. If a batch is "Filling" and zero flow persists for more than the user entered time then the batch will be aborted. This prevents over flows due to faulty flow sensors and/or wiring.

##### **Maximum Drain Time**

The unit declares that a batch is "done" when the flow rate equals "0". A flow rate may be present long after the Preset Relay de-energizes due to slow reacting valves or leaky valves. The Maximum Drain Time allows the user to enter an amount of time (0 to 99 seconds) to wait before declaring "Batch Done". After the Preset Batch quantity is reached, the unit will declare "Batch Done" when the flow rate is "0" or the Maximum Drain Time has expired. The batch data will then be available for printing and datalogging.

##### **Digital Control Valve**

Digital Control Valve Functions slow fill rate, fast fill rate, fill rate hysteresis are supported. Refer to Appendix B for concept diagram.

##### **Pump Control**

Optional functions for Relay 3 include its use for Pump ON/OFF control in either one stage, two stage or digital control valve applications.

### Slow Start Quantity

The Slow Start Quantity is a function that allows an amount to be entered for a Slow Start up. This function requires two stage valve control. RLY 1 (slow flow) will energize for Slow Start and RLY 2 (fast flow) will energize after the Slow Start Quantity has been delivered. This helps reduce turbulence when filling an empty container.

### START, RESET/START and STOP, STOP/RESET

When configuring the control inputs, Control Input1 can be set for START or RESET/START. When set for START, the unit will start batching when a signal is applied to Control Input1 or the front panel Start key is pressed. A separate Reset signal must be used to clear the previous batch total. When set for RESET/START, the unit will automatically reset then start when a signal is applied to Control Input1 or the front panel Start key is pressed (provided that the pervious batch was completed). If a previous batch was stopped during a batch cycle, the unit will Start from where it was stopped.

Control Input 2 can be set for STOP or STOP/RESET. When set for STOP, the unit will stop batching when a signal is applied to Control Input 2 or the front panel Stop key is pressed. A separate Reset signal must be used to clear the batch total. When set for STOP/RESET, a running batch will stop when a signal is applied to Control Input 2 or the front panel Stop key is pressed. If the unit is Stopped or after a completed batch, the unit will reset when a signal is applied to Control Input 2 or the front panel Stop key is pressed.

**NOTE:** Applying a voltage level to Control Input 2 will inhibit all Start inputs in either mode.

### Password Protection (Batch mode)

#### 5.4.2 Password Protection for Batcher Mode

After an Operator and/or Supervisor Password is entered in the setup mode (see section 6.3, SETUP PASSWORD submenu), the unit will be locked. The unit will prompt the user for the password when trying to perform the following functions:

- Clear Grand Total
- Enter Menu

The Supervisor password should be reserved for supervisors. The Supervisor password will allow access to restricted areas of the Setup and Test menus.

The passwords are factory set as follows:

- Operator = 0
- Supervisor = 2000

### Relay Operation (Batch mode)

#### 5.4.3 Relay Operation in Batcher mode

Up to four relays are available (two standard) for alarm outputs. Preset 1 (RLY1) is reserved for batch amount, Preset 2 (RLY2) is reserved for prewarn. (see section 5.4 Batcher Operation for Relay 1 & Relay 2 functions)

Preset 1 (RLY1) and Preset 2 (RLY2) are easily accessible by pressing the PRE 1 or PRE 2 key on the front panel. Preset 3 and Preset 4 are accessible only through the setup menu.

Relays 3 and 4 can be assigned to trip according to rate, total, temperature, overrun or alarm. When Rate is selected the relays can be programmed for low or high alarms.

### Pulse Output (Batch mode)

#### 5.4.4 Pulse Output in Batcher mode

The isolated pulse output (open collector) is menu assignable to Volume Total, Corrected Volume Total or Mass Total. The pulse output duration can be set for 10mS (50 Hz max) or 100mS (5 Hz max). A pulse output scale factor (pulse value) can be set to scale the pulse output. The pulse output is ideal for connecting to remote totalizers or other devices such as a PLC. See section 1.3 for electrical specifications.

### Analog Output (Batch mode)

#### 5.4.5 Analog Output in Batcher mode

The analog output is menu assignable to correspond to the Volume Rate, Corrected Volume Rate, Mass Rate, Temperature, Density, Volume Total, Corrected Volume Total or Mass Total. The analog output is ideal for "trend" tracking using strip chart recorders or other devices.

**RS-232 Serial Port**  
(Batch mode)**5.4.6 RS-232 Serial Port Operation in Batcher mode**

The RS-232 serial port can be used for programming (using the Setup Disk) or for communicating to printers and computers in the Operating Mode (Run Mode).

**PC Communications:**

The Setup Disk also allows the user to query the unit for operating status such as Flow Rate, Flow Total, Temperature, Density, Presets, etc.

**Operation of RS-232 Serial Port with Printers:**Transaction Printing

For transaction printing, the user defines the items to be included in the printed document (see section 6.3.20 SET DATA OUTPUT, Select\_list). The transaction document can be initiated by pressing the PRINT key, by a remote contact closure or print at end of batch.

Data Logging

In data logging, the user defines the items to be included in each data log (see section 6.3.20 SET PRINTER OUTPUT, Select\_list). The user can also select when (time of day) or how often (print interval) the data log is to be made (see section 6.3.19 SET PRINTER OUTPUT, Configure).

System Setup and Maintenance Report

The system setup and maintenance report lists all of the instrument setup parameters and usage for the current instrument configuration. The audit trail information and a status report is also printed. This report is initiated in the Test menu (see section 8.2.3 PRINT SYSTEM SETUP).

**RS-485 Serial Port**  
(Batch mode)**5.4.7 RS-485 Serial Port (optional)****RS-485 Port Description:**

The optional RS-485 card utilizes Modbus RTU protocol to access a variety of process parameters and totalizers. Batches/Relays can be controlled remotely via Modbus. In addition, action routines can be executed. For further information, contact factory and request RS-485 Protocol manual.

**Operation of Serial Communication Port with PC**

The flow computer's RS-485 channel supports a number of Modbus RTU commands. Modbus RTU drivers are available from third party sources for a variety of Man Machine Interface software for IBM compatible PC's.

The user reads and writes information from/to the RS-485 using the Modbus RTU commands. The Flow Computer then responds to these information and command requests.

Process variables and totalizers are read in register pairs in floating point format. Time and date are read as a series of integer register values. Alarms are individually read as coils. Action routines are initiated by writing to coils.

## 6. PROGRAMMING

### 6.1 Front Panel Operation Concept for Program Mode

The Flow Computer is fully programmable through the front panel. Please review the following usage summary before attempting to use the instrument.

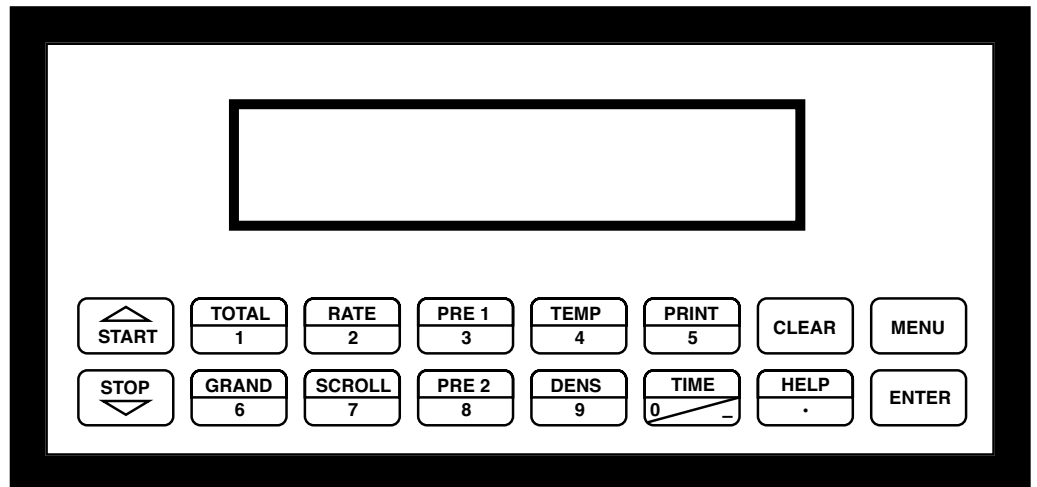

#### Setup Mode:

##### How To Make Mode Changes

#### **MODE CHANGES**

Pressing the MENU key will offer selections of RUN, SETUP, TEST. RUN is the normal operating mode for the instrument. SETUP offers various sub-menus used for instrument setup. TEST offers various sub-menus for Test, Calibration and System Start-up.

##### How To Navigate Through Sub-Menu Groups

#### **Submenu GROUP NAVIGATION**

Use the UP and DOWN arrow keys to navigate up and down through the Sub-Menu groups when in the SETUP or TEST mode. Press the ENTER key to enter a desired setup or test Sub-Menu group.

##### How To Select Program Choices

#### **SELECTION OF ITEM**

During setup, the unit will often offer multiple choices for a given topic. The topic prompt appears on the top line of the display. The choices are shown on the lower line of the display.

**To select an item, press the key beneath the desired choice. The selected choice will blink. Press the ENTER key to accept the selected choice.**

##### How To Enter Numeric Values

#### **NUMERIC ENTRY**

The keys labeled "0 - 9", "-", ".", CLEAR and ENTER are used to enter numerical values. A leading 0 will assume that you intend to enter a minus "-" sign. Press the CLEAR key to clear the existing value and to enable editing.

##### How To Enter Text Characters

#### **TEXT CHARACTER ENTRY**

Some setup items (i.e. Descriptors, Units Label) require the user to enter text characters. Press CLEAR to enable editing. The UP and DOWN arrow keys are used to scroll through the available character sets for each individual character. Press the ENTER key to accept the character and advance to the next character.













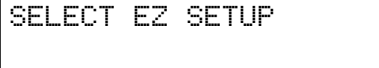

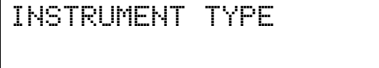

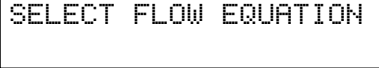



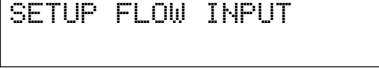

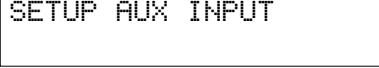









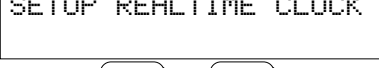

## 6.2 EZ Setup

The EZ Setup routine is a quick and easy way to configure the unit for the most commonly used instrument functions. This setup assumes that you are measuring Volumetric Flow using a high level, DC Pulsing flow sensor. Entering the EZ Setup mode automatically sets many features. This may cause any previously programmed information to be lost or reset. For a complete customized configuration, see sections 6.3 and 6.4.



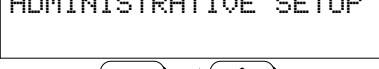













Menus	Display	Notes
6.2.1 TOP LEVEL SETUP MENU	<pre> SELECT OPERATE STATE Run   Setup   Test           </pre> <p style="text-align: center;">ENTER ↓</p>	Select Setup to enter the instrument setup routine.
	<pre> SELECT EZ SETUP           </pre> <p style="text-align: center;">ENTER ↓</p>	Press ENTER to begin EZ Setup routine.
6.2.2 EZ Setup Submenu Groups	<pre> ARE YOU SURE? No           Yes           </pre> <p style="text-align: center;">ENTER ↓</p>	Confirm that you want to run EZ Setup. <b>Caution:</b> Any previous program settings may be lost or reset.
	<pre> INSTRUMENT TYPE Rate/Tot    Batch           </pre> <p style="text-align: center;">ENTER ↓</p>	Instrument Type.
	<pre> RATE TIME BASE Sec Min Hour Day           </pre> <p style="text-align: center;">ENTER ↓</p>	Select the appropriate rate time base.
	<pre> RATE DEC PLACES           </pre> <p style="text-align: right;">0</p> <p style="text-align: center;">ENTER ↓</p>	Enter the desired rate decimal location. 0-3 decimal places allowed.
	<pre> TOTAL VOLUME UNITS           </pre> <p style="text-align: right;">gal</p> <p style="text-align: center;">ENTER ↓</p>	Enter the desired totalizer units label.
	<pre> TOTAL DEC PLACES           </pre> <p style="text-align: right;">0</p> <p style="text-align: center;">ENTER ↓</p>	Enter the desired totalizer decimal location. 0-3 decimal places allowed.
	<pre> K_FACTOR TYPE Avg   LinTbl   UVC           </pre> <p style="text-align: center;">ENTER ↓</p>	Enter the desired K-Factor Type.
	<pre> AVERAGE KA-FACTOR ##### P/gal           </pre>	If Average selected, Enter the desired Average K-Factor.
	<div style="display: inline-block; vertical-align: middle; text-align: center;">             Through 16 Points →           </div> <pre> LINEAR TABLE KA Fre01:##### Hz           </pre> <p style="text-align: center;">ENTER ↓</p> <pre> LINEAR TABLE KA KA--01:#####           </pre> <p style="text-align: center;">ENTER ↓</p>	If LinTbl or UVC selected, Enter the desired frequency/ K-Factor pair for each point in the Linearization Table.
		<pre> KA--01:#####           </pre> <p style="text-align: center;">ENTER ↓</p>
	<pre> FS ANALOG OUT 20mA #####gal/m           </pre> <p style="text-align: center;">ENTER ↓</p>	Enter the desired full scale setting for the analog output.
	<pre> RATE      00.0 gal/m TOTAL     0 gal           </pre>	Return to Run Mode



### 6.3 Setup Menus

Menus	Display	Notes
6.3.1 Top Level Setup Menu		Select Setup to enter the instrument setup routine.
6.3.2 Submenu Groups		Refer to Page 20 for Details.
		
		
		Refer to Page 22 for Details.
		
		Refer to Pages 22 for Details.
		
		Refer to Page 24 for Details.
		
		Refer to Page 26 for Details.
		
		Refer to Pages 29 for Details.
		
		Refer to Page 30 for Details.
		
		Refer to Pages 30 for Details.
		
		Refer to Page 31 for Details.
		
		Refer to Page 31 for Details.
		
		Refer to Page 33 for Details.
		
		Refer to Page 34 for Details.
		
		Refer to Page 35 for Details.
		
		Refer to Pages 36 for Details.
		
		Refer to Page 37 for Details.
		
		
		Refer to Page 38 for Details.

### 6.4 Setup Sub-Menus

Sub-menus	Display	Notes
6.4.1 SELECT EZ SETUP	<div style="border: 1px solid black; padding: 5px; text-align: center;">SELECT EZ SETUP</div> <div style="text-align: center; margin-top: 10px;">    </div> <p style="text-align: center;">Advance To INSTRUMENT TYPE</p>	<p>Refer to page 20 for EZ Setup routine.</p> <p>Press the DOWN (stop) key to advance to Instrument Type. Press the UP (start) key to advance to Administrative Setup.</p>
6.4.2 INSTRUMENT TYPE	<div style="border: 1px solid black; padding: 5px; text-align: center;">INSTRUMENT TYPE</div>	<p>Press ENTER to enter Instrument Type sub-menus.</p>
Rate/Tot	<div style="border: 1px solid black; padding: 5px; text-align: center;">           INSTRUMENT TYPE  <span style="background-color: black; color: white; padding: 2px;">Rate/Tot</span>      Batch         </div> <div style="text-align: center; margin-top: 5px;">  </div> <div style="border: 1px solid black; padding: 5px; text-align: center;">           INSTRUMENT TYPE  <span style="background-color: black; color: white; padding: 2px;">Rate/Tot</span>      Batch         </div> <div style="text-align: center; margin-top: 5px;">    </div> <p style="text-align: center;">Advance To SELECT FLOW EQUATION</p>	<p>Press ENTER when Rate/Total is flashing to configure the instrument as a Ratemeter/Totalizer.</p> <p>If Rate/Tot selected, advance to Select Flow Equation.</p>
	<div style="border: 1px solid black; padding: 5px; text-align: center;">INSTRUMENT TYPE</div>	<p>Press ENTER to enter Instrument Type sub-menus.</p>
	<div style="border: 1px solid black; padding: 5px; text-align: center;">INSTRUMENT TYPE</div>	
<b>NOTE:</b> See Appendix B for Batching Diagrams	<p data-bbox="269 1177 345 1212"><b>Batch</b></p> <div style="border: 1px solid black; padding: 5px; text-align: center;">           INSTRUMENT TYPE            Rate/Tot      <span style="background-color: black; color: white; padding: 2px;">Batch</span> </div> <div style="text-align: center; margin-top: 5px;">    </div> <div style="border: 1px solid black; padding: 5px; text-align: center;">           SELECT PRESET TYPE            Standard      EZ Preset         </div> <div style="text-align: center; margin-top: 5px;">    </div> <div style="border: 1px solid black; padding: 5px; text-align: center;">           SELECT VALVE TYPE            Standard      Digital         </div> <div style="text-align: center; margin-top: 5px;">    </div> <p style="text-align: center;">Continue on Next Page</p>	<p>Press ENTER when Batch is flashing to configure the instrument as a Batcher.</p> <p>Select Standard or EZ Preset</p> <p>Choose Standard or Digital Valve Type. Press ENTER to select choice.</p>

**Sub-menus**

6.4.2 INSTRUMENT TYPE INSTRUMENT TYPE  
(continued)

**Notes**

Press ENTER to enter Instrument Type sub-menus.

SLOW FILL RATE 10

Enter the Slow Fill Rate. Press ENTER to store.



FULL FILL RATE 1000

Enter the Full Fill Rate (Fast Fill Rate). Press ENTER to store.



BATCH COUNT MODE  
Up Down

Select UP to Reset to 0 and count up to preset. Select DOWN to reset to Preset and count down to 0.



MAXIMUM BATCH PRESET  
1000.0 gal

Enter the maximum allowable Batch Preset. The operator will not be able to enter a batch preset larger than this value.



BATCH OVERRUN COMP  
Off On

Select ON to set the unit to operate using a Batch Overrun Compensation routine. Select OFF to inhibit Batch Overrun Compensation routine. (See Section 5.4)



FLOW SIGNAL TIMEOUT 10

Enter a timeout of 0 to 99 seconds. If a batch is "Filling" and zero flow persists for more than this time, the batch will be aborted.



MAXIMUM DRAIN TIME 10

Enter time (0-99 sec.) for Max. Drain Time. After batch quantity is reached, "Batch Done" is declared when the flow rate is "0" or the Maximum Drain Time has expired.



SLOW START QUANTITY 10

Enter a quantity for a Slow Start up. RLY 2 (slow flow) will energize for Slow Start and RLY 1 (fast flow) will energize after the Slow Start Quantity has been delivered.



Advance To  
SELECT FLOW EQUATION

<u>Sub-menus</u>	<u>Display</u>	<u>Notes</u>
6.4.3 SELECT FLOW EQUATION	<pre>SELECT FLOW EQUATION</pre> <p style="text-align: center;">ENTER ↓</p>	Press ENTER to enter Select Flow Equation submenus.
	<pre>SELECT FLOW EQUATION Volume Mass Cor/Vol</pre> <p style="text-align: center;">ENTER ↓</p> <p style="text-align: center;">Advance To SETUP INDICATORS (Total)</p>	Press ENTER when desired flow equation is flashing.
6.4.4 SETUP INDICATORS (Total)	<pre>SETUP INDICATORS</pre> <p style="text-align: center;">ENTER ↓</p>	Press ENTER to begin setup of the Indicators
	<pre>SETUP INDICATORS Total Dens Rate Temp</pre> <p style="text-align: center;">ENTER ↓</p>	Press ENTER when Total is flashing to configure the Totalizer Indicators
	<pre>TOTAL DESCRIPTOR TOTAL</pre> <p style="text-align: center;">ENTER ↓</p>	Enter the desired Total Descriptor
	<pre>TOTAL VOLUME UNITS gal</pre> <p style="text-align: center;">ENTER ↓</p>	Enter the desired Volume Units Label for the Totalizer.
	<pre>TOTAL DEC PLACES 0</pre> <p style="text-align: center;">ENTER ↓</p> <p style="text-align: center;">Advance To SETUP INDICATORS (Density)</p>	Select the desired Total Decimal Place. 0-3 decimal places allowed.
	<pre>SETUP INDICATORS Total Dens Rate Temp</pre> <p style="text-align: center;">ENTER ↓</p>	Press ENTER when Dens is flashing to configure the Density Indicators.
6.4.5 SETUP INDICATORS (Density)	<pre>DENSITY DESCRIPTOR DENS</pre> <p style="text-align: center;">ENTER ↓</p>	Enter the desired Density Descriptor.
	<pre>DENSITY MASS UNITS lbs</pre> <p style="text-align: center;">ENTER ↓</p>	Enter the desired Mass Units Label for Density.
	<pre>DENSITY DEC PLACES 0</pre> <p style="text-align: center;">ENTER ↓</p> <p style="text-align: center;">Advance To SETUP INDICATORS (Rate)</p>	Select the desired Density Decimal Place. 0-3 decimal places allowed.

**Sub-menus**

**Display**

**Notes**

**6.4.6**  
**SETUP**  
**INDICATORS**  
 (Rate)

```

SETUP INDICATORS
Total Dens Rate Temp
  
```

Press ENTER when Rate is flashing to configure the Ratemeter Indicators



```

RATE TIME BASE
Sec Min Hour Day
  
```

Select the desired Rate Time Base.



```

RATE DESCRIPTOR
                                RATE
  
```

Enter the desired Descriptor for the Ratemeter.



```

RATE DEC PLACES
                                0
  
```

Select the desired Rate Decimal Place. 0-3 decimal places allowed.



```

RATE AVG FILTER
                                0
  
```

Enter desired Rate Averaging Filter.



```

QUICK UPDATE %
                                5
  
```

Enter desired Percent of Change for Quick Update. If the current flowrate deviates by an amount greater than the percentage value entered, the Rate Averaging is inhibited. (See Page 57 for more details.)



Advance To  
 SETUP INDICATORS  
 (Temperature)

**6.4.7**  
**SETUP**  
**INDICATORS**  
 (Temperature)

```

SETUP INDICATORS
Total Dens Rate Temp
  
```

Press ENTER when Temp is flashing to configure the Temperature Indicators.



```

TEMP DESCRIPTOR
                                TEMP
  
```

Enter the desired Temperature Descriptor.



```

TEMPERATURE SCALE
Deg_C                                Deg_F
  
```

Enter the desired Temperature Scale.



```

TEMP DEC PLACES
                                0
  
```

Select the desired Temperature Decimal Place. 0-3 decimal places allowed.



Advance To  
 SETUP FLOW INPUT

**Sub-menus**

**Display**

**Notes**

**6.4.8  
SETUP  
FLOW INPUT**  
(Pulse - Ain & PS  
(A=B))

**NOTE:**  
Ain = Single Pulse  
PS(A=B) = Pulse  
Security  
Qx1 = Quadrature  
Qx2 = Quadrature x 2

SETUP FLOW INPUT

Press ENTER to begin setup of Flow Input.



EXCITATION VOLTAGE  
5v      12v      24v

Select the desired Excitation Voltage.



FLOW INPUT TYPE  
Pulse      Analog

Press ENTER when Pulse is flashing to configure the flow input for Pulse signals.



PULSE INPUT TYPE  
Ain    PS(A=B)    Qx1    Qx2

Enter the desired Pulse type. See side note.



PULSE TRIGGER LEVEL  
10mV    100mV    2.5V

Select the desired Input Pulse Trigger Level.



LOW PASS FILTER  
40Hz    3KHz    20KHz

Select the desired Low Pass Filter.  
(Max. Count Speed).



INPUT TERMINATION  
Pullup    Pulldown    None

Select the proper input termination.



MAX WINDOW (1-99)  
1

Enter the desired Maximum Sample Window Time (1-99 sec).



K\_FACTOR TYPE  
Avg      LinTbl      UVC

Enter the desired K-Factor Type.



AVERAGE KA-FACTOR  
##### P/gal

If Avg selected, Enter the desired Average K-Factor.

LINEAR TABLE KA  
Fre01:##### Hz

If LinTbl selected,  
Enter the desired frequency/ K-Factor pair for each point in the Linearization Table.



LINEAR TABLE KA  
KA--01:##### P/gal

**NOTE:** Enter 0 for Fre value of any point (other than Fre01) to exit the routine and use the values entered up to that point.



LOW FLOW RATE ALARM  
##### gal/m

Enter the desired volumetric Low Rate Alarm. This will trigger an alarm message if alarm conditions occur. The relays are not affected.



HIGH FLOW RATE ALARM  
##### gal/m

Enter the desired volumetric High Rate Alarm. This will trigger an alarm message if alarm conditions occur. The relays are not affected.

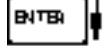

Advance To  
SETUP AUX INPUTS

Through 16 Points











Submenus	Display	Notes
<b>6.4.9 SETUP FLOW INPUT</b> (Pulse - Quadrature, Qx1 or Qx2)	<pre>           SETUP FLOW INPUT           </pre>	Press ENTER to begin setup of Flow Input.
	<pre>           EXCITATION VOLTAGE           5v      12v      24v           </pre>	Select the desired Excitation Voltage.
	<pre>           FLOW INPUT TYPE           Pulse      Analog           </pre>	Press ENTER when Pulse is flashing to configure the flow input for Pulse signals.
<b>NOTE:</b> Ain = Single Pulse PS(A=B) = Pulse Security Qx1 = Quadrature Qx2 = Quadrature x 2	<pre>           PULSE INPUT TYPE           Ain PS(A=B) Qx1 Qx2           </pre>	Enter the desired Pulse type. See side note.
	<pre>           PULSE TRIGGER LEVEL           10mV      100mV      2.5V           </pre>	Select the desired Input Pulse Trigger Level.
	<pre>           LOW PASS FILTER           40Hz      3KHz      20KHz           </pre>	Select the desired Low Pass Filter. (Max. Count Speed).
	<pre>           INPUT TERMINATION           Pullup Pulldown None           </pre>	Select the proper input termination.
	<pre>           MAX WINDOW (1-99)                                      1           </pre>	Enter the desired Maximum Sample Window Time (1-99 sec).
	<pre>           K_FACTOR TYPE           Avg      LinTbl      UVC           </pre>	Enter the desired K-Factor Type.
	<pre>           AVERAGE KA-FACTOR           ##### P/gal           </pre>	If Avg selected, Enter the desired Average K-Factor (KA for channel A).
	<pre>           AVERAGE KB-FACTOR           ##### P/gal           </pre>	Enter the desired Average K-Factor (KB for channel B).
	<pre>           LINEAR TABLE KA           Fre01:##### Hz           </pre>	If LinTbl selected, Enter the desired frequency/ K-Factor pair for each point in the Linearization Table. (channel A)
	<pre>           LINEAR TABLE KA           KA--01:##### P/gal           </pre>	<b>NOTE:</b> Enter 0 for Fre value of any point (other than Fre01) to exit the routine and use the values entered up to that point.
	<pre>           LINEAR TABLE KB           Fre01:##### Hz           </pre>	Enter the desired frequency/ K-Factor pair for each point in the Linearization Table. (channel B)
	<pre>           LINEAR TABLE KB           KA--01:##### P/gal           </pre>	<b>NOTE:</b> Enter 0 for Fre value of any point (other than Fre01) to exit the routine and use the values entered up to that point.
	<pre>           LOW FLOW RATE ALARM           ##### gal/m           </pre>	Enter the desired volumetric Low Rate Alarm. This will trigger an alarm message if alarm conditions occur. The relays are not affected.
	<pre>           HIGH FLOW RATE ALARM           ##### gal/m           </pre>	Enter the desired volumetric High Rate Alarm. This will trigger an alarm message if alarm conditions occur. The relays are not affected.
	Advance To SETUP AUX INPUTS	





Through 16 Points















Sub-menus	Display	Notes
6.4.10 SETUP FLOW INPUT (Analog)	<pre>SETUP FLOW INPUT</pre>	Press ENTER to begin setup of the Flow Input.
	<pre> ENTER ↓ EXCITATION VOLTAGE 5v      12v      24v     </pre>	Select the desired Excitation Voltage.
	<pre> ENTER ↓ FLOW INPUT TYPE Pulse      Analog     </pre>	Press ENTER when Analog is flashing to configure the flow input for Analog signals .
	<pre> ENTER ↓ ANALOG SIGNAL TYPE Voltage      Current     </pre>	Choose Analog Signal Type.
	<pre> ENTER ↓ ANALOG VOLTAGE RANGE 0-10V      0-5V      1-5V     </pre>	If Voltage selected, Choose desired Voltage Range.
	<pre> ENTER ↓ ANALOG CURRENT RANGE 4-20mA      0-20mA     </pre>	If Current selected, Choose desired Current Range.
	<pre> ENTER ↓ LINEARIZATION TYPE Linear      Sqrt      LinTbl     </pre>	Select the desired Linearization Type.
	<pre> ENTER ↓ LINEAR TABLE KA APR01:##### gal/m     </pre>	If LinTbl selected, Enter the desired Apparent Input Flow (APR) / Correction Factor (CFr) pair for each point in the Linearization Table.
	<pre> ENTER ↓ LINEAR TABLE KA CFr01:#####     </pre>	<b>NOTE:</b> Enter 0 for APR value of any point (other than APR01) to exit the routine and use the values entered up to that point.
Through 16 Points	<pre> ENTER ↓ FLOW LOW SCALE ##### gal/m     </pre>	Enter the low flowrate corresponding to the low analog signal.
	<pre> ENTER ↓ FLOW FULL SCALE ##### gal/m     </pre>	Enter the High flowrate corresponding to the High analog signal.
	<pre> ENTER ↓ LOW FLOW CUTOFF ##### gal/m     </pre>	Enter the desired Low Flow Cutoff.
	<pre> ENTER ↓ LOW FLOW RATE ALARM ##### gal/m     </pre>	Enter the desired volumetric Low Rate Alarm. This will trigger an alarm message if alarm conditions occur. The relays are not affected.
	<pre> ENTER ↓ HIGH FLOW RATE ALARM ##### gal/m     </pre>	Enter the desired volumetric High Rate Alarm. This will trigger an alarm message if alarm conditions occur. The relays are not affected.
	<pre> ENTER ↓ Advance To SETUP AUX INPUT     </pre>	



Sub-menus	Display	Notes
6.4.11 SETUP AUX INPUT	<pre>           SETUP AUX INPUT           </pre>	Press ENTER to begin setup of the Auxiliary Input.
<b>NOTE:</b> When Density (Dens) is selected, The menu prompts will be very similar to the Temperature prompts. The menus will prompt the user for density values and density units.	<pre>           ENTER ↓           </pre>	
	<pre>           AUX INPUT TYPE           None   Dens   Temp           </pre>	Select Temperature to set the Auxiliary Input for Temperature inputs.
	<pre>           ENTER ↓           </pre>	
	<pre>           AUX SIGNAL TYPE           Voltage Current  RTD           </pre>	Choose Temperature Signal Type. Advance to "Aux Default", if RTD selected.
	<pre>           ENTER ↓           </pre>	
	<pre>           INPUT SIGNAL RANGE           0-10V   0-5V   1-5V           </pre>	If Voltage selected, Choose desired Voltage Range. Skip if RTD.
	<pre>           INPUT SIGNAL RANGE           4-20mA   0-20mA           </pre>	If Current selected, Choose desired Current Range. Skip if RTD.
	<pre>           ENTER ↓           </pre>	
	<pre>           AUX LOW SCALE           ##### F           </pre>	Enter the low temperature scale corresponding to the low temperature signal. Skip if RTD.
	<pre>           ENTER ↓           </pre>	
	<pre>           AUX FULL SCALE           ##### F           </pre>	Enter the high temperature scale corresponding to the high temperature signal. Skip if RTD.
	<pre>           ENTER ↓           </pre>	
	<pre>           AUX DEFAULT           ##### F           </pre>	Enter the Default Temperature. The unit will use this value if the temperature input fails.
	<pre>           ENTER ↓           </pre>	
	<pre>           AUX LOW ALARM           ##### F           </pre>	Enter the Low setpoint for the Temperature Alarm.
	<pre>           ENTER ↓           </pre>	
	<pre>           AUX HIGH ALARM           ##### F           </pre>	Enter the High setpoint for the Temperature Alarm.
	<pre>           ENTER ↓           </pre>	
	<pre>           DENS EXTRACT METHOD           Therm_Coef  API_2540           </pre>	Choose the Density Extraction method to be used.
	<pre>           ENTER ↓           </pre>	
	<p>Advance To SET FLUID PROPERTIES</p>	

Sub-menus	Display	Notes	
<b>6.4.12</b> <b>SET FLUID</b> <b>PROPERTIES</b>	SET FLUID PROPERTIES	Press ENTER at this prompt to Set Fluid Properties.	
		REF. DENSITY ##### lbs/g	Enter the Reference Density. This is used in the calculation of density when you have a temp transmitter and used for corrected flow calculation if you have a density transmitter.
		REF. TEMPERATURE ##### F	Enter the Reference Temperature.
		EXPAN. FACTOR [xe-6] #####	Enter the proper Expansion Factor. (If Temp Compensated for Mass or Corrected Volume) See Section 7.4, Calculating the Expansion Factor.
		CALIBRATION DENSITY #####	Enter the Calibration Density. This is used in calculation of flow for analog inputs using SQRT.
		VISCOSITY COEF. A 0.000	Enter the Viscosity A Coefficient. See section 7.5, Computation of Viscosity Coef. A and B.
		VISCOSITY COEF. B 0.000	Enter the Viscosity B Coefficient. See section 7.5, Computation of Viscosity Coef. A and B.
		BASE DENSITY H2O@4C ##### lbs/g	Enter the Base Density H2O@4C. This is used in the centistoke calculation for UVC.
		Advance To SETUP PULSE OUTPUT	

<b>6.4.13</b> <b>SETUP</b> <b>PULSE OUTPUT</b>	SETUP PULSE OUTPUT	Press ENTER at this prompt to setup the Pulse Output.	
		PULSE OUTPUT USAGE Off Vol CVol/Mass	Select the desired Pulse Output Usage.
		PULSE WIDTH 10mS 100mS	Select the desired Pulse Width for the Pulse Output.
		PULSE VALUE ##### gal/P	Enter the desired Pulse Value for the Pulse Output (Units per Pulse).
		Advance To SETUP ANALOG OUTPUT	

Sub-menus	Display	Notes	
<b>6.4.14</b> <b>SETUP</b> <b>ANALOG OUTPUT</b>	SETUP ANALOG OUTPUT	Press ENTER when Analog is flashing to setup the Analog Output.	
		ANALOG OUTPUT USAGE Rate Total Temp Dens	Select the desired Analog Output Usage.
		ANALOG OUT FLOW TYPE Vol CVol/Mass	Only if Rate selected & Flow EQ. = Mass, Cor/Vol Select the desired Analog Output Flow.
		ANALOG OUTPUT RANGE 4-20mA 0-20mA	Select the desired current range for the Analog Output.
		LS ANALOG OUTPUT ##### gal/m	Enter desired Analog Output Low Scale Value. <b>NOTE:</b> Units label will correspond with output usage type selected.
		FS ANALOG OUT 20mA ##### gal/m	Enter desired Analog Output Full Scale Value.
		ANALOG OUT DAMPING 0.0	Enter the desired Analog Output Damping Constant.
		<b>Advance To</b> <b>SETUP RELAYS</b>	
<b>6.4.15</b> <b>SETUP RELAYS</b> <b>(Relay 1 &amp; Relay 2)</b>	SETUP RELAYS R1y1 R1y2 R1y3 R1y4	Select the desired Relay for setup. (Relays 3 & 4 Optional)	
		RELAY 1 USAGE RATE TOTAL NA	If Relay 1 or Relay 2 Selected, Select Rate, Total or NA.
		RELAY 1 DELAY sec 0	If Rate selected, enter desired relay activation delay value.
		RELAY 1 MODE LO_ALARM HI_ALARM	Select the desired Relay Activation. Low: Relay activates when reading is below setpoint. High: Relay activates when reading is above setpoint.
		RELAY 1 DURATION #####	If Total Selected, Enter desired Relay Duration.
		RELAY 1 SETPOINT ##### gal	Enter the desired Setpoint. The Setpoint can be edited in run mode using the PRE 1 key (PRE 2 key for Relay 2).
		RELAY 1 HYSTERESIS ##### gal/m	If Rate, selected, Enter desired Relay Hysteresis.
		<b>Advance To</b> <b>SETUP RELAYS 3, 4</b>	

**NOTE:**  
 In Batch mode, Relay 1 is reserved for Preset, Relay 2 is reserved for Prewarn.







When using Digital Control Valves Relay -2 is required to be assigned to Prewarn. The numerical value of the prewarn corresponds to the slow end of flow. This value must be greater than maximum amount of valve over-shoot possible when the valve is closing.













Sub-menus	Display	Notes
<b>6.4.15 (Continued)</b> <b>SETUP RELAYS</b> <b>(Relay 3 &amp; Relay 4)</b>	<pre> SETUP RELAYS R1y1 R1y2 R1y3 R1y4                 </pre> <p style="text-align: center;">ENTER ↓</p>	Select the desired Relay for setup. (Relays 3 & 4 Optional)
<b>NOTE:</b> Settings for Relays 3 & 4 may be entered even if relays are not supplied. The settings will still trigger display alarms.	<pre> RELAY 3  USAGE Rate Tot Aux Ovr PMP                 </pre> <p style="text-align: center;">ENTER ↓</p> <pre> RELAY 4  USAGE Rate Tot Aux Alrm NA                 </pre> <p style="text-align: center;">ENTER ↓</p>	If Relay 3 Selected, Choose Rate, Total, Aux, Ovr (overun) or PMP (pump on/off).  If Relay 4 Selected, Choose Rate, Total, Aux, Alrm or NA.
	<pre> RELAY 3 DELAY      sec                    0                 </pre> <p style="text-align: center;">ENTER ↓</p>	If Rate / Aux selected, enter desired relay activation delay value.
	<pre> RELAY 3 MODE LO_ALARM   HI_ALARM                 </pre> <p style="text-align: center;">ENTER ↓</p>	Select the desired Relay Activation for Rate/Aux. Low: Relay activates when reading is below setpoint. High: Relay activates when reading is above setpoint.
	<pre> RELAY 3 DURATION                    #####                 </pre> <p style="text-align: center;">ENTER ↓</p>	If Total Selected, Enter desired Relay Duration.
	<pre> RELAY 3 SETPOINT                    ##### gal                 </pre> <p style="text-align: center;">ENTER ↓</p>	Enter the desired Setpoint.
	<pre> RELAY 3 HYSTERESIS                    ##### gal/m                 </pre> <p style="text-align: center;">ENTER ↓</p>	If Rate, selected, Enter desired Relay Hysteresis.
	<p><b>Advance To</b>  <b>SETUP CONTROL INPUTS</b></p>	

**RELAY NOTES & CONSIDERATIONS**











1. Relay activation is based on the computed readings not the displayed value. Therefore the display damping factor will not affect the relay response time. The RELAY DELAY feature allows the user to enter a time delay for relay activation. This feature is very useful in applications where short over/under range conditions are not considered alarm conditions.
2. When INSTRUMENT TYPE is set to batcher, Relay 1 is reserved for PRESET and Relay 2 is reserved for PREWARN.
3. Setting the relays to NA (Not Assigned), will allow the relay activation to be controlled via the RS-232 Serial and/or RS-485 Modbus ports.
4. Relay 3 and Relay 4 settings may be used to trigger display alarm conditions even if the relays are not supplied.

Sub-menus	Display	Notes
<b>6.4.16</b> <b>SETUP CONTROL</b> <b>INPUTS</b> (RATE/TOTAL)	<pre>           SETUP CONTROL INPUTS           ┌───────────────────┐           │                   │           │                   │           │                   │           └───────────────────┘           [ENTER] ↓           SETUP CONTROL INPUTS           Input1 Input2 Input3           ┌───────────────────┐           │                   │           │                   │           └───────────────────┘           [ENTER] ↓           CONTROL INPUT1 USAGE           INHIBIT_TOTAL  NA           ┌───────────────────┐           │                   │           │                   │           └───────────────────┘           CONTROL INPUT2 USAGE           RESET_TOTAL   NA           ┌───────────────────┐           │                   │           │                   │           └───────────────────┘           CONTROL INPUT3 USAGE           Prn Ack KeyLk NA           ┌───────────────────┐           │                   │           │                   │           └───────────────────┘           [ENTER] ↓           Advance To           SETUP REALTIME CLOCK         </pre>	<p>Press Enter to begin setup of the Control Inputs.</p> <p>Select the desired Control Input for setup.</p> <p>If Control Input 1 Selected, Select Inhibit Total or NA (Not Assigned).</p> <p>If Control Input 2 Selected, Select Reset Total or NA (Not Assigned).</p> <p>If Control Input 3 Selected, Select Prn (Print), Ack (acknowledge), KeyLk (Keylock) or NA (Not Assigned). ACK will acknowledge and clear alarms and warning messages.</p> <p><b>Note:</b> Alarms may reassert themselves if alarm conditions are still present.</p>
<b>6.4.17</b> <b>SETUP CONTROL</b> <b>INPUTS</b> (BATCH)	<pre>           SETUP CONTROL INPUTS           Input1 Input2 Input3           ┌───────────────────┐           │                   │           │                   │           └───────────────────┘           [ENTER] ↓           CONTROL INPUT1 USAGE           Start Rst/Start NA           ┌───────────────────┐           │                   │           │                   │           └───────────────────┘           CONTROL INPUT2 USAGE           Stop Stop/Rst NA           ┌───────────────────┐           │                   │           │                   │           └───────────────────┘           CONTROL INPUT3 USAGE           Rst Prn KeyLk Ack NA           ┌───────────────────┐           │                   │           │                   │           └───────────────────┘           [ENTER] ↓           Advance To           SETUP REALTIME CLOCK         </pre>	<p>Select the desired Control Input for setup.</p> <p>If Control Input 1 Selected, Select Start ,Reset/Start, NA (Not Assigned).</p> <p>If Control Input 2 Selected, Select Stop, Stop/Reset, NA (Not Assigned).</p> <p>If Control Input 3 Selected, Select Prn (Print), Ack (acknowledge), KeyLk (Keylock) or NA (Not Assigned). ACK will acknowledge and clear alarms and warning messages.</p> <p><b>Note:</b> Alarms may reassert themselves if alarm conditions are still present.</p>

Sub-menus	Display	Notes
<b>6.4.18</b> <b>SETUP REALTIME</b> <b>CLOCK</b> (Time)	SETUP REALTIME CLOCK	Press Enter to begin setup of the Realtime Clock.
		
	SETUP REALTIME CLOCK Time Date	Select Time to set the time.
		
	CLOCK TYPE 24HR 12HR	Select 24Hr or 12Hr clock
		
	SELECT CLOCK AM/PM AM PM	If 12Hr Clock, Enter AM or PM
		
	TIME OF DAY HH:MM:SS ##:##:##	Enter time of day.
		
	Advance To SETUP REALTIME CLOCK (Date)	
<b>6.4.19</b> <b>SETUP REALTIME</b> <b>CLOCK</b> (Date)	SETUP REALTIME CLOCK Time Date	Select Date to enter the date.
		
	DATE: MONTH, DAY, YEAR ##/##/####	Enter the date. (Month, Day, Last two digits of Year)
		
	Advance To SERIAL USAGE	

Sub-menus	Display	Notes
6.4.20 SERIAL USAGE	SERIAL USAGE	Press Enter to begin setup of the Serial Port.
		
	SERIAL HARDWARE RS232 RS485	Select Serial Hardware type for standard port. (See SETUP NETWORK CARD for RS485 Modbus option)
		
	DEVICE ID ##	Select the Device ID.
		
	BAUD RATE 300 600 1200 <more>	Select the desired Baud Rate.
	BAUD RATE 2400 4800 9600 19200	(If <more> selected)
		
	PARITY None Odd Even	Select the desired Parity.
		
	HANDSHAKING None Software Hardwre	Set the Handshake.
		
	DEVICE LINE FEED <CR> <CR+LF>	Choose end of line termination. Only choose <CR> if your external device automatically assigns a line feed for every <CR> carriage return.
		
	MODEM OPTIONS No Yes	Select "Yes" if the serial port will be used to control a modem.
		
	MODEM INIT MASTER No Yes	Select "Yes" to have the unit engage in a configuration conversation with the modem on power up .
		
	MODEM AUTO ANSWER No Yes	Select the desired Modem Auto Answer mode.
		
	CALL OUT DAY OF WEEK Friday	Enter the day of week to perform Call Out transmission.
		
	CALL OUT TIME ##:##:##	Enter the time of day to perform Call Out transmission.
		
	CALL ON ERROR/ALARM No Yes	Select "Yes" to have the unit perform a Call Out transmission upon error/alarm condition.
		

Continued on Next Page

Sub-menus	Display	Notes	
<b>6.4.20</b> <b>SERIAL USAGE</b> (continued)	CALL OUT PHONE # 0	Enter the Call Out Phone Number to be dialed for "Call Out Time" or "Print On Error/Alarm".	
		NUMBER OF REDIALS 0	Enter the number of redials to be performed on call out time if busy or no answer. (error/ alarm tries until connected)
		HANGUP IF 2MIN INACT No Yes	Select "Yes" to perform hangup if there is inactivity for more than 2 minutes.
Advance To SETUP DATALOG/PRINT			
<b>6.4.21</b> <b>SETUP</b> <b>DATALOG/PRINT</b> (Configure)	SETUP DATALOG/PRINT	Press Enter to setup the Datalog/Print information.	
		SETUP DATALOG/PRINT Config Select_list	Select Config to configure the Datalog/Print information.
		OUTPUT FORMAT Printer Term Dbase	Select the type of Output Format.
		PAGE LENGTH [66 max] 66	Enter the desired Page Length. If Printer selected above.
		TOP MARGIN [60 max] 3	Enter the desired Top Margin. If Printer selected above.
		DATALOG PRINT ONLY No Yes	Select Yes to record events to the datalogger only. Events will not be sent to the serial port.
		PRINT TIME HH:MM:SS 00:00:00	Enter Print Time, printer will print at this time every day. Enter 00:00:00 to inhibit print time.
		PRINT INTERVAL 00:00:00	Enter Print Interval, Enter 00:00:00 to inhibit print interval..
		ENABLE PRINT KEY NO YES	Select YES to enable Print Key. Select NO to disable Print Key
		PRINT END OF BATCH NO YES	Batch mode only. Select Yes to print at end of batch.
Advance To SETUP DATALOG/PRINT (Select_list)			



Sub-menus	Display	Notes
<b>6.4.22</b> <b>SETUP</b> <b>DATALOG/PRINT</b> (Select_list)	<pre>                     SET DATALOG/PRINT                     [ENTER]                     SET DATALOG/PRINT                     Config Select_list                     PRINT LIST ITEMS                     TOTAL YES                     PRINT LIST ITEMS                     RATE YES                     PRINT LIST ITEMS                     PRE 1 YES                     [ENTER]                     PRINT LIST ITEMS                     DataLog size =001489                     [ENTER]                     Advance To                     ADMINISTRATIVE SETUP                 </pre>	<p>Press enter to begin Setup Datalog/Print routine.</p> <p>Press enter when Select_list is selected to setup print list.</p> <p>Use Up and Down arrow keys to view list status. Press the Corresponding function key to the items that you wish to add or remove from the list. Items marked with Yes will be added to the list, items marked with No will be removed from the list.</p> <p>The Select Print List Information display shows the current possible Datalog size.</p>
<b>List Items:</b> TOTAL RATE PRE1 TEMP GRAND PRE2 DENS TIME		
<b>6.4.23</b> <b>ADMINISTRATIVE</b> <b>SETUP</b>	<pre>                     ADMINISTRATIVE SETUP                     [ENTER]                     TAG NUMBER                     FT####                     [ENTER]                     OPERATOR PASSWORD                     *****                     [ENTER]                     SUPERVISOR PASSWORD                     *****                     [ENTER]                     SOFTWARE VERSION                     Vxx.xx                     [ENTER]                     PRODUCT ORDER CODE                     xxxxxxxxxxxx                     [ENTER]                     UNIT SERIAL NUMBER                     00000                     [ENTER]                     SENSOR SERIAL NUMBER                     00000                     [ENTER]                     Advance To                     SETUP NETWORK CARD                 </pre>	<p>Press Enter to begin Administrative Setup.</p> <p>Enter Tag Number</p> <p>Enter Operator Password. (Factory Set to 0)</p> <p>Enter Supervisor Password. (Factory Set to 2000)</p> <p>This display is used to show the software version of the installed software.</p> <p>This display is used to show the product order code (model number).</p> <p>This display is used to show the unit's serial number.</p> <p>This display is used to show the sensor's serial number.</p>

**6.4.24  
 SETUP  
 NETWORK CARD  
 (optional)**

```

  SETUP NETWORK CARD
  
```

Press Enter to setup Network Card



```

  SELECT NTW PROTOCOL
  ModbusRTU
  
```

Select desired Network Protocol.



```

  NETWORK DEVICE ID
  1
  
```

Enter the device address on network (00-255).



```

  BAUD RATE
  2400 4800 9600 19200
  
```

Select the desired Baud Rate.



```

  PARITY
  None      Odd      Even
  
```

Select the desired Parity.



```

  Advance To
  SELECT EZ SETUP?
  
```

## 7. Principle Of Operation

### General Operation

#### 7.1 General:

The Flow Computer uses several internal calculations to compute the compensated flow based on specific data input. Several computations are performed to arrive at the uncompensated flow, temperature, density and viscosity. This information is then used to compute the Corrected Volume Flow or Mass Flow.

### Orifice Flowmeter Considerations

#### 7.2 Orifice Flowmeter Considerations:

Head class flowmeters are supplied by the manufacturers with a 4-20 mA output span which is already in flow units. The Flow Computer permits the user to enter this flowmeter information directly. However, closely associated with this information is the density that was assumed during flowmeter calibration. This information must also be input if the user is to obtain maximum accuracy.

It is assumed that the user has the printout from a standardized orifice sizing program for the particular device he will be using. Such standardized printouts list all the necessary information which the user will then be prompted for.

Several specialized flow equations are listed that are not intended for the standard unit but to be offered to appropriate OEMs or as special order items. These are designated by a "†".

#### Note concerning Fluid Information

The user will be prompted for Fluid Information during the setup of the instrument. The Factory will be preparing application information for several common fluid types.

### Flow Equations

#### 7.3 Flow Equations:

##### Input Flow Computation:

##### Linear or External SQRT

$$\text{Input Flow} = [\% \text{ input span} * (\text{flow FS} - \text{flow low scale})] + \text{flow low scale}$$

##### Orifice

$$\text{Input Flow} = [(\sqrt{\% \text{ input span}}) * (\text{flow FS} - \text{flow low scale})] + \text{flow low scale}$$

##### Input Flow Computation:

##### General Case

$$T_f = [\% \text{ input span} * (\text{temp FS} - \text{Temp low scale})] + \text{temp low scale}$$

##### RTD Case

$$T_f = f(\text{measured input resistance})$$

##### Input Density Computation:

##### Temperature Transmitter

$$\text{density} = \text{reference density} * (1 - \text{Therm.Exp.Coef.} * (T_f - T_{ref}))^2$$

##### Density Transmitter

$$\text{density} = [\% \text{ input span} * (\text{density FS} - \text{density low scale})] + \text{density low scale}$$

### 7.3 Flow Equations: (Continued)

#### Flow Equations Input Viscosity Computation:

$$\dagger \text{ centistokes} = \frac{\left( A \exp \frac{B}{(\text{Deg F} + 459.67)} \right)}{\text{Absolute Density}}$$

Where: centistokes = cP/(kg/l)

#### Uncompensated Flow Computation:

##### Pulse Input; Average K-Factor

$$\text{Volume Flow} = \frac{\text{input frequency} * \text{time scale factor}}{\text{K-Factor}}$$

##### Pulse Input; Linear Table

$$\text{Volume Flow} = \frac{\text{input frequency} * \text{time scale factor}}{\text{K-Factor (Hz)}}$$

##### Pulse Input; UVC

$$\dagger \text{ Volume Flow} = \frac{\text{input frequency} * \text{time scale factor}}{\text{K-Factor (Hz/cstk)}}$$

##### Analog Input; Linear

$$\text{Volume Flow} = \text{input flow}$$

##### Analog Input; Linear Table

$$\text{Volume Flow} = \text{input flow} * \text{correction factor (input flow)}$$

##### Analog Input; Orifice or External SQRT

$$\text{Volume Flow} = \text{input flow} * \frac{\sqrt{(\text{calibrated density})}}{\sqrt{(\text{density})}}$$

##### Analog Input; Orifice Linear Table or External SQRT Linear Table

$$\dagger \text{ Volume Flow} = \text{CF(rn)} * \text{input flow} * \frac{\sqrt{(\text{calibrated density})}}{\sqrt{(\text{density})}}$$

#### Corrected Volume Flow Computation:

##### Temperature Transmitter

$$\text{Standard Volume Flow} = \text{volume flow} * (1 - \text{Therm.Exp.Coef.} * (\text{Tf} - \text{Tref}))^2$$

##### Density Transmitter

$$\text{Standard Volume Flow} = \text{volume flow} * \frac{\text{density}}{\text{reference density}}$$

#### Mass Flow Computation:

$$\text{Mass Flow} = \text{volume flow} * \text{density}$$

† These special flow equations are not available in the standard unit. They are to be offered to OEMs or as special order items.

### 7.3 Flow Equations: (Continued)

#### Flow Equations

**API 2540 Equation.** The American Petroleum Institute, in a joint program with the National Bureau of Standards (NIST), developed a density equation based on 463 samples of five different oil products. The results of this work are incorporated into Chap. 11.1, "Volume Correction Factors," of API Standard 2540 (1987).

The density equation is based on the thermal-expansion coefficient of the product at 60°F (15.6°C) base temperature, which is calculated from the base density as

$$\alpha_b = \frac{K_0}{\rho_b^{*2}} + \frac{K_1}{\rho_b^*} \quad (2.188)$$

where the base density  $\rho_b^*$  is in kilograms per cubic meter. The empirically derived constants  $K_0$  and  $K_1$  for the five product groups are given in Table 2.23. The density of the product at flowing temperature is then calculated as

$$\rho_F^* = \rho_b^* \exp [-\alpha_b \Delta T_F (1 + 0.8 \alpha_b \Delta T_F)] \quad (2.189)$$

where  $\Delta T_F = T_F - 60$ . The specific gravity at flowing or measured temperature is then

**TABLE 2.23** Constants  $K_0$  and  $K_1$  for Five Product Groups

Product group	$K_0$	$K_1$
Crude oils and JP4†	341.0957	0.0
Jet fuels, kerosenes, solvents	330.3010	0.0
Gasolines and naphthenes	192.4571	0.2438
Lubricating oils	144.0427	0.1895
Diesel oil, heating oils, fuel oils	103.8720	0.2701

*Note:* Pentanes and hydrocarbons lower in the hydrocarbon chain are *not* covered by this data.

†API News Release 1987 added JP4.

The above information was obtained from "Flow Measurement Engineering Handbook, 3rd Edition" by Richard W Miller.

## 7.4 Calculating the Expansion Factor

### Calculating Expansion Factor

The liquid density is a function of the flowing temperature for many fluids. This unit solves an equation which represents this physical property of the fluid.

The information which the unit uses to describe the fluid is entered by the user in the following variables: Reference Temperature, Reference Density, Expansion Factor.

This information is available for many fluids in one or more of the following forms:

Fluid Specific Gravity vs. Temp. Table

Specific Gravity vs. Temp. Graph

Fluid Density vs. Temp. Table

Fluid Density vs. Temp. Graph

Begin by obtaining one of the fluid properties for the fluid you are using from available manufacturers information or Engineering Handbooks. In some cases this information is listed on the Material Safety Data Sheet for the fluid.

Two temperature-specific gravity pairs will be required to compute the temperature coefficient.

The reference temperature is simply chosen by the user. Common reference temperatures are 60° F or 15° C.

However, for cryogenic fluids, the normal boiling point may also be used. In some cases the fluid data may list properties at 100° F, this temperature may also be used as the reference temperature.

The reference temperature should be chosen so that it is in the application temperature range. i.e. application temperature range -10 to 120° F, reference temperature of 60° F chosen.

Enter the reference temperature you have chosen at this point.

The reference specific gravity corresponds to the fluid SPECIFIC GRAVITY at the reference temperature chosen.

You may convert the fluid density information to specific gravity if it is in units other than specific gravity. Use EQ1.

### Expansion Factor Equations

EQ1.

$$\text{Spec.Grav.} = \text{Density of Fluid} / \text{Density of Water}$$

Given the reference temperature, reference specific gravity, a second temp. and a second Spec.Grav., the Expansion Factor (C Factor) can be computed as follows:

EQ2. Used for Liquid Mass and Corrected Volume Equations

$$C = \left[ \frac{1 - \sqrt{(\text{Spec.Grav.2} / \text{Ref.Spec.Grav.})}}{\text{Temp.2} - \text{Ref.Temp}} \right] \times 1,000,000$$

Given the reference temperature, reference density, a second temp. and a second density, the Expansion Factor (C Factor) can be computed as follows:

EQ3. Used for Liquid Mass and Corrected Volume Equations

$$C = \left[ \frac{1 - \sqrt{(\text{Dens.2} / \text{Ref.Dens.})}}{\text{Temp.2} - \text{Ref.Temp}} \right] \times 1,000,000$$

## 7.5 Computation of Viscosity Coef. A and B

### Computation of Viscosity Coef. A & B

The flow computer solves an equation which computes the viscosity as a function of temperature. Two parameters must be entered for this calculation to be performed. These are the setup parameters Viscosity Coef. A and Viscosity Coef. B. A table listing these values for common fluids is available from THE FACTORY.

Alternately, if your intended fluid is not listed, the Viscosity Coef. A and B can be derived from two known temperature/viscosity pairs. Begin by obtaining this information for you intended fluid. Convert these known points to units of Degrees F and centipoise (cP)

The information is now in a suitable form to compute the Viscosity Coef. A and Viscosity Coef. B using the following equation based on the fluid state.

For a liquid, A and B are computed as follows:

$$B = \frac{(T1 + 459.67) \cdot (T2 + 459.67) \cdot \ln [ cP1/cP2 ]}{(T2 + 459.67) - (T1 + 459.67)}$$

$$A = \frac{cP1}{\exp [ B / ( T1 + 459.67 ) ]}$$

**NOTE:** cS =  $\frac{cP \cdot \text{Density of Water at } 4^{\circ}\text{C}}{\text{Density of Liquid}}$

## 7.6 Linearization Table

### Linearization Table General Information

#### 7.6.1 Linearization Table General Information

The Linearization Table is used when the flow input device gives a nonlinear input signal. The unit uses up to 16 different points, as entered by the operator, to form a curve for linearizing the input signal.

Notes:

- 1) A minimum of three points must be set up.
- 2) If "0" is entered for the frequency of any point other than point 1, the Flow Computer assumes there are no more points above the points that preceded them. The display will advance to the next setup prompt. Extrapolation is taken from the last two nonzero points.
- 3) If the input frequency is above the highest or below the lowest frequency programmed, the unit will use the last known point for the K factor in computing the resulting actual flow.
- 4) Frequencies or apparent flows should be entered in ascending order.

### Linearization Table (Pulse Inputs)

#### 7.6.2 Linearization Table for Pulse Inputs

The linearization table for pulse inputs programming is quite simple when values of frequency and flow are known. The Flow Computer asks for 16 different frequencies (Freq) and 16 corresponding K factors (K). It then uses this data to determine what the actual flow is for any given input frequency. Usually the necessary data is provided with the flowmeter.

### Linearization Table (Analog Inputs)

#### 7.6.3 Linearization Table for Analog Inputs

The Linearization Table for Analog inputs programming is similar to the Pulse input setup. The Flow Computer asks for 16 different flow rates (apparent flow) and 16 corresponding Correction Factors. It then uses this data to determine what the Actual flow is for any given apparent input signal. Again, a minimum of three points must be set up.

$$\text{Correction factor} = \frac{\text{Actual Flow}}{\text{Apparent Input Flow}}$$

The same rules that applied for the Digital setup apply for the Analog setup as well.

The Flow Computer prompts you for the Apparent input signal (APR) and a correction factor (CFr) to multiply it by to yield true actual flow.

### Linearization Table Interpolation

#### 7.6.4 Linearization Table Interpolation

The Linearization Table routine uses the entered data to determine the K factor for any given input frequency or input flow signal. This is done by taking the closest data points above and below the input signal, then using those points to extrapolate the K factor (correction factor), then calculating the uncompensated flow from the data. Below are the formulas.

Parameters:

Determine closest point above input signal  
 signal = X, K factor (correction factor) = KA

Determine closest point below input signal  
 signal = Y, K factor (correction factor) = KB

Let input signal = H,  
 unknown K factor (correction factor) = KN

To find KN use this formula:

$$\frac{H - Y}{X - Y} \times (KA - KB) + KB = KN$$

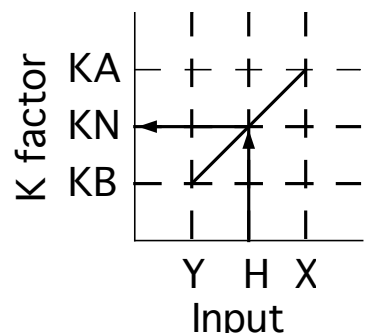













## 8. Test, Service and Maintenance

### 8.1 Test Menus









Menus	Display	Notes
8.1.1 TOP LEVEL TEST MENU	<div style="border: 1px solid black; padding: 5px;">                     SELECT OPERATE STATE                      Run    Setup    <b>Test</b> </div> <p style="text-align: center;">ENTER ↓</p>	Select Test to enter the instrument test & calibration routine. <b>NOTE:</b> Supervisor (Service) password required to gain access to this mode.
	<p style="text-align: center;">START ↑</p> <div style="border: 1px solid black; padding: 5px;">                     Audit Trail                 </div>	Refer to Page 40 for Details.
	<p style="text-align: center;">STOP ↓    START ↑</p> <div style="border: 1px solid black; padding: 5px;">                     Error history                 </div>	Refer to Page 40 for Details.
	<p style="text-align: center;">STOP ↓    START ↑</p> <div style="border: 1px solid black; padding: 5px;">                     Print System Setup                 </div>	Refer to Page 40 for Details.
	<p style="text-align: center;">STOP ↓    START ↑</p> <div style="border: 1px solid black; padding: 5px;">                     Keypad Test                 </div>	Refer to Page 41 Details.
	<p style="text-align: center;">STOP ↓    START ↑</p> <div style="border: 1px solid black; padding: 5px;">                     Display test                 </div>	Refer to Page 41 for Details.
	<p style="text-align: center;">STOP ↓    START ↑</p> <div style="border: 1px solid black; padding: 5px;">                     Calibrate                 </div>	Refer to Pages 42 - 46 for Details.
	<p style="text-align: center;">STOP ↓    START ↑</p> <div style="border: 1px solid black; padding: 5px;">                     Analog In Test                 </div>	Refer to Page 46 Details.
	<p style="text-align: center;">STOP ↓    START ↑</p> <div style="border: 1px solid black; padding: 5px;">                     Pulse input test                 </div>	Refer to Page 47 for Details.
	<p style="text-align: center;">STOP ↓    START ↑</p> <div style="border: 1px solid black; padding: 5px;">                     Analog out test                 </div>	Refer to Page 47 for Details.
	<p style="text-align: center;">STOP ↓    START ↑</p> <div style="border: 1px solid black; padding: 5px;">                     Excitation out test                 </div>	Refer to Page 47 for Details.
	<p style="text-align: center;">STOP ↓    START ↑</p> <div style="border: 1px solid black; padding: 5px;">                     Pulse out test                 </div>	Refer to Page 48 for Details.
	<p style="text-align: center;">STOP ↓    START ↑</p> <div style="border: 1px solid black; padding: 5px;">                     Relay Test                 </div>	Refer to Page 48 for Details.
	<p style="text-align: center;">STOP ↓    START ↑</p> <div style="border: 1px solid black; padding: 5px;">                     Control inputs test                 </div>	Refer to Page 48 for Details.
	<p style="text-align: center;">STOP ↓    START ↑</p> <div style="border: 1px solid black; padding: 5px;">                     Battery Voltage Test                 </div>	Refer to Page 49 for Details.
	<p style="text-align: center;">STOP ↓</p> <div style="border: 1px solid black; padding: 5px;">                     Data logger utility                 </div>	Refer to Page 49 for Details.







**8.2 Test Sub-Menus**





<u>Sub-menus</u>	<u>Display</u>	<u>Notes</u>
<b>8.2.1</b> <b>Audit Trail</b> <b>Submenu Group</b>	<div style="border: 1px solid black; padding: 5px; width: fit-content; margin: 0 auto;">Audit Trail</div>	Press Enter to view the audit trail information.
	<div style="text-align: center;">  </div>	The audit trail is viewed in this format: nnnnn= number of critical menu changes, hh:mm:ss; mm/dd/yy = time and date of last change.
	<div style="border: 1px solid black; padding: 5px; width: fit-content; margin: 0 auto;">                     Audit Trail      nnnnn                      hh:mm:ss      mm/dd/yy                 </div> <div style="text-align: center;">  </div>	Press Menu to get back to audit trail top-level menu.
<b>8.2.2</b> <b>Error History</b> <b>Submenu Group</b>	<div style="border: 1px solid black; padding: 5px; width: fit-content; margin: 0 auto;">Error history</div>	Press Enter to view error history. <b>NOTE:</b> Press Print Key to print Error History. Printout will include time/date of each errors first occurrence.
	<div style="text-align: center;">  </div>	
	<div style="border: 1px solid black; padding: 5px; width: fit-content; margin: 0 auto;">                     Error history                      Flow rate alarm low                 </div> <div style="text-align: center;">  </div>	Press Up/Down arrow keys to scroll through error message history. Press CLEAR to clear entire error log.
<b>8.2.3</b> <b>Print System Setup</b> <b>Submenu Group</b>	<div style="border: 1px solid black; padding: 5px; width: fit-content; margin: 0 auto;">Print System Setup</div>	Press enter key to enter print system setup submenu
	<div style="text-align: center;">  </div>	
	<div style="border: 1px solid black; padding: 5px; width: fit-content; margin: 0 auto;">                     Print System Setup                      Press ENTER to print                 </div> <div style="text-align: center;">  </div>	Press enter to begin printing the system setup.
	<div style="border: 1px solid black; padding: 5px; width: fit-content; margin: 0 auto;">                     Print System Setup                      -- Printing ---                 </div> <div style="text-align: center;">  </div>	This message will display as the data transmission takes place.
	<div style="border: 1px solid black; padding: 5px; width: fit-content; margin: 0 auto;">Print System Setup</div>	Press Menu to get back to print system setup top-level menu.







<u>Sub-menus</u>	<u>Display</u>	<u>Notes</u>
<b>8.2.4</b> <b>Keypad test</b> <b>Submenu Group</b>	<div style="border: 1px solid black; padding: 5px; text-align: center;">Keypad test</div>	Press Enter to enter keypad test
	<div style="text-align: center;">  </div> <div style="border: 1px solid black; padding: 5px; text-align: center;">           Keypad test            Key pressed-&gt; ENTER         </div>	Press the various keys and the display will show the key that was pressed. Press Menu to exit the test
	<div style="text-align: center;">  </div> <div style="border: 1px solid black; padding: 5px; text-align: center;">Keypad test</div>	Press Menu to get back to Keypad test top-level menu.
<b>8.2.5</b> <b>Display test</b> <b>Submenu Group</b>	<div style="border: 1px solid black; padding: 5px; text-align: center;">Display test</div>	Press Enter to enter display test.
	<div style="text-align: center;">  </div> <div style="border: 1px solid black; padding: 5px; text-align: center;">           000000000000000000000000            000000000000000000000000         </div>	Upon pressing enter the each digit on the display will scroll 0-9 then A-Z. Press menu to exit the test.
	<div style="text-align: center;">  </div> <div style="border: 1px solid black; padding: 5px; text-align: center;">Display test</div>	Press Menu to get back to Display test top-level menu.













**ALL UNITS ARE CALIBRATED AT THE FACTORY PRIOR TO SHIPMENT**  
**CAUTION:**  
 This unit must be calibrated using precision and calibrated equipment.  
 Equipment needed is as follows: Frequency Generator, Digital Multimeter,  
 Precision Current/Voltage Source, Oscilloscope, Frequency Counter.

<u>Sub-menus</u>	<u>Display</u>	<u>Notes</u>
Calibration Submenu Group	<div style="border: 1px solid black; padding: 5px; display: inline-block;">Calibrate</div>	Press Enter to begin the calibration routine. (Please note the caution above)
		
8.2.6 Calibrate CH1 0mA Submenu Group	<div style="border: 1px solid black; padding: 5px; display: inline-block;">Calibrate ch1 0mA Iin=TB1-3 GND=TB1-4</div>	Connect Current Source (+) TB1-3, (-) TB1-4. Input 0mA and press Enter.
		
	<div style="border: 1px solid black; padding: 5px; display: inline-block;">Calibrate ch1 0mA CALIBRATING --</div>	This message is displayed during calibration.
		
	<div style="border: 1px solid black; padding: 5px; display: inline-block;">Calibrate ch1 0mA *** DONE ***</div>	This message is displayed when the 0mA calibration is finished.
		
	<div style="border: 1px solid black; padding: 5px; display: inline-block;">Calibrate ch1 0mA Iin=TB1-3 GND=TB1-4</div>	The display will automatically return to the Calibrate CH1 0mA submenu. Press the Down arrow key to advance to the CH1 20mA calibration.
		
8.2.7 Calibrate CH1 20mA Submenu Group	<div style="border: 1px solid black; padding: 5px; display: inline-block;">Calibrate ch1 20mA Iin=TB1-3 GND=TB1-4</div>	Connect Current Source (+) TB1-3, (-) TB1-4. Input 20mA and press Enter.
		
	<div style="border: 1px solid black; padding: 5px; display: inline-block;">Calibrate ch1 20mA 0 CALIBRATING --</div>	This message is displayed during calibration.
		
	<div style="border: 1px solid black; padding: 5px; display: inline-block;">Calibrate ch1 20mA *** DONE ***</div>	This message is displayed when the 20mA calibration is finished.
		
	<div style="border: 1px solid black; padding: 5px; display: inline-block;">Calibrate ch1 20mA Iin=TB1-3 GND=TB1-4</div>	The display will automatically return to the Calibrate CH1 20mA submenu. Press the Down arrow key to advance to the CH2 0mA calibration.
		
	<p>Advance to</p> <div style="border: 1px solid black; padding: 5px; display: inline-block;">Calibrate ch2 0mA</div>	

Sub-menus	Display	Notes
<b>8.2.8</b> <b>Calibrate CH2 0mA</b> Submenu Group	<pre>Calibrate ch2    0mA Iin=TB1-8  GND=TB1-4</pre>	To Calibrate: Connect Current Source (+) TB1-8, (-) TB1-4. Input 0mA and press Enter.
		
	<pre>Calibrate ch2    0mA  0 CALIBRATING --</pre>	This message is displayed during calibration.
	<pre>Calibrate ch2    0mA *** DONE ***</pre>	This message is displayed when the 0mA calibration is finished.
		
	<pre>Calibrate ch2    0mA Iin=TB1-8  GND=TB1-4</pre>	The display will automatically return to the Calibrate CH2 0mA submenu. Press the Down arrow key to advance to the CH2 20mA calibration.
		
<b>8.2.9</b> <b>Calibrate CH2 20mA</b> Submenu Group	<pre>Calibrate ch2    20mA Iin=TB1-8  GND=TB1-4</pre>	To Calibrate: Connect Current Source (+) TB1-8, (-) TB1-4. Input 20mA and press Enter.
		
	<pre>Calibrate ch2    20mA  0 CALIBRATING --</pre>	This message is displayed during calibration.
	<pre>Calibrate ch2    20mA *** DONE ***</pre>	This message is displayed when the 20mA calibration is finished.
		
	<pre>Calibrate ch2    20mA Iin=TB1-8  GND=TB1-4</pre>	The display will automatically return to the Calibrate CH2 20mA submenu. Press the Down arrow key to advance to the CH1 0V calibration.
		
	Advance to Calibrate ch1 0V	







Sub-menus	Display	Notes
<b>8.2.10</b> <b>Calibrate CH1 0V</b> <b>Submenu Group</b>	<pre>Calibrate ch1  0V Uin=TB1-2  GND=TB1-4</pre>	To Calibrate: Connect Voltage Source (+) TB1-2, (-) TB1-4. Input 0V and press Enter.
		
	<pre>Calibrate ch1  0V 0 CALIBRATING --</pre>	This message is displayed during calibration.
	<pre>Calibrate ch1  0V *** DONE ***</pre>	This message is displayed when the 0V calibration is finished.
	<pre>Calibrate ch1  0V Iin=TB1-2  GND=TB1-4</pre>	The display will automatically return to the Calibrate CH1 0V submenu. Press the Down arrow key to advance to the CH1 10V calibration.
		
<b>8.2.11</b> <b>Calibrate CH1 10V</b> <b>Submenu Group</b>	<pre>Calibrate ch1  10V Iin=TB1-2  GND=TB1-4</pre>	To Calibrate: Connect Voltage Source (+) TB1-2, (-) TB1-4. Input 10V and press Enter.
		
	<pre>Calibrate ch1  10V 0 CALIBRATING --</pre>	This message is displayed during calibration.
	<pre>Calibrate ch1  10V *** DONE ***</pre>	This message is displayed when the 10V calibration is finished.
	<pre>Calibrate ch1  10V Iin=TB1-2  GND=TB1-4</pre>	The display will automatically return to the Calibrate CH1 10V submenu. Press the Down arrow key to advance to the CH2 0V calibration.
		
	<p style="text-align: center;">Advance to Calibrate ch2  0V</p>	

Sub-menus	Display	Notes
<b>8.2.12</b> <b>Calibrate CH2 0V</b> <b>Submenu Group</b>	<pre>Calibrate ch2    0V Vin=TB1-5  GND=TB1-4</pre>	To Calibrate: Connect Voltage Source (+) TB1-5, (-) TB1-4. Input 0V and press Enter.
		This message is displayed during calibration.
	<pre>Calibrate ch2    0V  0 CALIBRATING --</pre>	This message is displayed when the 0V calibration is finished.
	<pre>Calibrate ch2    0V *** DONE ***</pre>	The display will automatically return to the Calibrate CH2 0V top-level menu. Press the Down arrow key to advance to the CH2 10V calibration.
<b>8.2.13</b> <b>Calibrate CH2 10V</b> <b>Submenu Group</b>	<pre>Calibrate ch2    0V Iin=TB1-5  GND=TB1-4</pre>	
	<pre>Calibrate ch2    10V Iin=TB1-5  GND=TB1-4</pre>	To Calibrate: Connect Voltage Source (+) TB1-5, (-) TB1-4. Input 10V and press Enter.
		This message is displayed during calibration.
	<pre>Calibrate ch2    10V  0 CALIBRATING --</pre>	This message is displayed when the 10V calibration is finished.
<pre>Calibrate ch2    10V *** DONE ***</pre>	The display will automatically return to the Calibrate CH2 10V top-level menu. Press the Down arrow key to advance to the 100 ohm RTD calibration.	
<pre>Calibrate ch2    10V Iin=TB1-5  GND=TB1-4</pre>		
<p style="text-align: center;">Advance to Calibrate 100ohm RTD</p>		
<b>8.2.14</b> <b>Calibrate 100 ohm</b> <b>RTD</b> <b>Submenu Group</b>	<pre>Calibrate 100ohm RTD JMP TB1-6,7 100R=7,8</pre>	
	<pre>Calibrate 100ohm RTD  0 CALIBRATING --</pre>	This message is displayed during calibration.
	<pre>Calibrate 100ohm RTD *** DONE ***</pre>	This message is displayed when the RTD calibration is finished.
	<pre>Calibrate 100ohm RTD JMP TB1-6,7 100R=7,8</pre>	
<p style="text-align: center;">Advance to Calibrate 4mA out</p>	The display will automatically return to the Calibrate 100 ohm RTD top-level menu. Press the Down arrow key to advance to the 4mA out calibration.	

Sub-menus	Display	Notes
<b>8.2.15</b> <b>Calibrate 4mA Out</b> <b>Submenu Group</b>	<pre>Calibrate 0mA out + TB1-15      - TB1-16</pre>	Connect ammeter to (+) TB1-15, (-) TB1-16. Press enter.
	 <pre>Calibrate 0mA out Enter mA: 0.00000</pre>	To trim 0mA output: Press CLEAR to enable editing and enter a small negative number (i.e. -0.100) to force a display reading, then clear and enter small quantity measured on your meter.
	 <pre>Calibrate 0mA out + TB1-15      - TB1-16</pre> 	The display will return to Calibrate 0mA out. Press the down arrow key to advance to Cal. 20mA out or repeat above if necessary.
<b>8.2.16</b> <b>Calibrate 20mA Out</b> <b>Submenu Group</b>	<pre>Calibrate 20mA out + TB1-15      - TB1-16</pre>	Connect ammeter to (+) TB1-15, (-) TB1-16. Press enter.
	 <pre>Calibrate 20mA out Enter mA: 20.00000</pre>	To trim 20mA output: Press CLEAR to enable editing and enter the current reading that is on the ammeter display. Press enter.
	 <pre>Calibrate 20mA out + TB1-15      - TB1-16</pre> 	The display will automatically return to the Calibrate 20mA out submenu. Calibration is complete.
	<pre>Calibrate</pre>	Press the Menu key to go back to Calibrate top-level menu.
<b>8.2.17</b> <b>Analog In Test</b> <b>Submenu Group</b>	<pre>Analog In Test</pre>	Press enter to test the analog inputs.
	 <pre>Analog In Test Volts T2:00.000  T5:00.000</pre> 	To check voltage input accuracy: Use TB1-4 as Reference Ground, input 0-10 Volts to TB1-2 and/or TB1-5. Display should show voltage being input. Use voltage meter to verify input.
	 <pre>Analog In Test mA T3:00.000  T8:00.000</pre> 	To check current input accuracy: Use TB1-4 as Reference Ground, input 0-20mA to TB1-3 and/or TB1-8. Display should show current being input. Use ammeter to verify input.
	 <pre>Analog In Test OHMS RTD          00.000</pre> 	To check RTD input accuracy: Connect a jumper wire between TB1-6 and TB1-7, Place a 100 ohm 0.1% resistor between TB1-7 and TB1-8. Display should show 100 ohms ±0.1%.
	<pre>Analog In Test</pre>	Press Menu key to return to Analog In Test



Sub-menus	Display	Notes
<b>8.2.18</b> <b>Pulse input test</b> <b>Submenu Group</b>	<div style="border: 1px solid black; padding: 5px; text-align: center;">Pulse input test</div> <p style="text-align: center;">ENTER ↓</p> <div style="display: flex; align-items: center;"> <div style="margin-right: 10px;">           2.5V            10mV            100mV         </div> <div style="border: 1px solid black; padding: 5px; text-align: center;">           Pulse input test            Trigger level 2.5V         </div> </div> <p style="text-align: center;">ENTER ↓</p> <div style="display: flex; align-items: center;"> <div style="margin-right: 10px;">           40Hz            3KHz            20kHz         </div> <div style="border: 1px solid black; padding: 5px; text-align: center;">           Pulse input test            count speed 3kHz         </div> </div> <p style="text-align: center;">ENTER ↓</p> <div style="border: 1px solid black; padding: 5px; text-align: center;">           Pulse input test            F1: 0 F2: 0         </div> <p style="text-align: center;">MENU ↓</p> <div style="border: 1px solid black; padding: 5px; text-align: center;">Pulse input test</div>	<p>top-level menu.</p> <p>Press Enter key to test the pulse input.</p> <p>Use the Up/Down arrow keys to select the appropriate trigger level.</p> <p>Use the Up/Down arrow keys to select the appropriate frequency range.</p> <p>To check Pulse input accuracy: Use TB1-4 as reference ground, input a frequency on TB1-2. The display should show frequency being input. Use a frequency counter to verify input.</p> <p>Press Menu key to return to Pulse input test top-level menu.</p>
<b>8.2.19</b> <b>Analog out test</b> <b>Submenu Group</b>	<div style="border: 1px solid black; padding: 5px; text-align: center;">Analog out test</div> <p style="text-align: center;">ENTER ↓</p> <div style="border: 1px solid black; padding: 5px; text-align: center;">           Analog out test            *0 4 10 15 20 mA         </div> <p style="text-align: center;">MENU ↓</p> <div style="border: 1px solid black; padding: 5px; text-align: center;">Analog out test</div>	<p>Press Enter to test the analog output.</p> <p>To simulate analog output: Connect an ammeter to (+) TB1-15, (-) TB1-16. Press the key under the desired setting to move the asterisk (*). The unit should output the selected current.</p> <p>Press Menu key to return to Analog out test top-level menu.</p>
<b>8.2.20</b> <b>Excitation out test</b> <b>Submenu Group</b>	<div style="border: 1px solid black; padding: 5px; text-align: center;">Excitation out test</div> <p style="text-align: center;">ENTER ↓</p> <div style="border: 1px solid black; padding: 5px; text-align: center;">           Excitation out test            *5v 12v 24v         </div> <p style="text-align: center;">MENU ↓</p> <div style="border: 1px solid black; padding: 5px; text-align: center;">Excitation out test</div>	<p>Press Enter to test the excitation output.</p> <p>To test the excitation output: Connect a voltmeter to (+) TB1-1, (-) TB1-4. Press the key under the desired setting to move the asterisk (*). The unit should output the selected voltage.</p> <p>Press Menu key to return to Excitation out test top-level menu.</p>

<u>Sub-menus</u>	<u>Display</u>	<u>Notes</u>
<p>8.2.21 Pulse out test Submenu Group</p>	<div style="border: 1px solid black; padding: 5px; text-align: center;">Pulse out test</div> <div style="text-align: center; margin: 5px 0;">  </div> <div style="border: 1px solid black; padding: 5px; text-align: center;">           Pulse out test            *0Hz 1Hz 10Hz 20Hz         </div> <div style="text-align: center; margin: 5px 0;">  </div> <div style="border: 1px solid black; padding: 5px; text-align: center;">Pulse out test</div>	<p>Press Enter key to test the pulse output.</p> <p>To simulate a frequency on the pulse output: Connect a frequency counter to (+)TB1-13, (-)TB1-14. Press the key under the desired setting to move the asterisk (*). The unit should output the selected frequency.</p>
<p>8.2.22 Relay test Submenu Group</p>	<div style="border: 1px solid black; padding: 5px; text-align: center;">Relay Test</div> <div style="text-align: center; margin: 5px 0;">  </div> <div style="border: 1px solid black; padding: 5px; text-align: center;">           R1y1 R1y2 R1y3 R1y4            Off Off Off Off         </div> <div style="text-align: center; margin: 5px 0;">  </div> <div style="border: 1px solid black; padding: 5px; text-align: center;">Relay Test</div>	<p>Press Enter to test the relays.</p> <p>To manually control the relay outputs: Press the key under the desired relay to toggle the relays On/Off. Use an ohmmeter to check the relay contacts.</p> <p>Press Menu key to return to Relay Test top-level menu.</p>
<p>8.2.23 Control input test Submenu Group</p>	<div style="border: 1px solid black; padding: 5px; text-align: center;">Control inputs test</div> <div style="text-align: center; margin: 5px 0;">  </div> <div style="border: 1px solid black; padding: 5px; text-align: center;">           TB1-9 TB1-10 TB1-11            Off Off Off         </div> <div style="text-align: center; margin: 5px 0;">  </div> <div style="border: 1px solid black; padding: 5px; text-align: center;">Control inputs test</div>	<p>Press Enter to test the control inputs.</p> <p>To check the control inputs: Use TB1-12 as reference, input a DC signal to TB1-9, TB1-10 and/or TB1-11, The Display will show ON when input is active, OFF when inactive.</p> <p>Press Menu key to return to control input test top-level menu.</p>

<u>Sub-menus</u>	<u>Display</u>	<u>Notes</u>
<b>8.2.24</b> <b>Battery Voltage test</b> <b>Submenu Group</b>	<div style="border: 1px solid black; padding: 5px; text-align: center;">Battery Voltage Test</div>	Press Enter key to view the battery voltage.
	<div style="border: 1px solid black; padding: 5px; text-align: center;">Battery Voltage Test 3.312 Volts</div>	The display will show the battery voltage. Replace battery at 2.5 VDC or below.
	<div style="border: 1px solid black; padding: 5px; text-align: center;">Battery Voltage Test</div>	Press Menu key to return to battery voltage test top-level menu.
<b>8.2.25</b> <b>Data logger utility</b> <b>Submenu Group</b>	<div style="border: 1px solid black; padding: 5px; text-align: center;">Data logger utility</div>	Press Enter to use data logger utility.
	<div style="border: 1px solid black; padding: 5px; text-align: center;">Data logger utility Log 10            958 Max</div>	The displays shows the number of Data Logs. Press the Down arrow key to advance to PRT (print) or CLR (clear).
	<div style="border: 1px solid black; padding: 5px; text-align: center;">Data logger utility Log 00001       PRT CLR</div>	Press PRINT key to output data logger logs to printer, Press CLEAR key to clear the data logger contents.
	<div style="border: 1px solid black; padding: 5px; text-align: center;">Data logger utility</div>	Press Menu key to return to Data logger utility top-level menu.

### 8.3 Internal Fuse Replacement

#### Instructions:

1. Make sure you follow proper E.S.D. Precautions. All persons performing this replacement must follow proper grounding procedures.
2. Turn the power to the unit off.
3. Disconnect the two piece connector rear terminal block, leaving all connections in place.
4. Remove the unit from the panel.
5. Remove the four machine screws (see fig. 1) which hold the two sections of the case together.
6. The rear section of the case should detach from the rest of the case. It may be necessary to cut the wiring label along the joint where the two sections connect. With the rear section of the case removed the fuse will be exposed (located near the rear terminal, AC connection).
7. Locate the Fuse F1 (see fig. 2) and unplug the fuse from its socket.
8. Insert the new fuse into the socket. Insure that the pins are fully inserted and straight.
9. Reassemble the case and install the four machine screws which join the two sections of the case.
10. Reinstall the unit into the panel.
11. Reconnect the rear terminal block.
12. Turn the unit back on.

#### Fuse Specifications:

- |                  |                |                                   |
|------------------|----------------|-----------------------------------|
| 110 VAC Power:   | 160mA/250V, TD | Wickman 19372-030-k or equivalent |
| 220 VAC Power:   | 80mA/250V, TD  | Wickman 19372-026-k or equivalent |
| 12/24 VDC Power: | 800mA/250V, TD | Wickman 19374-046-k or equivalent |

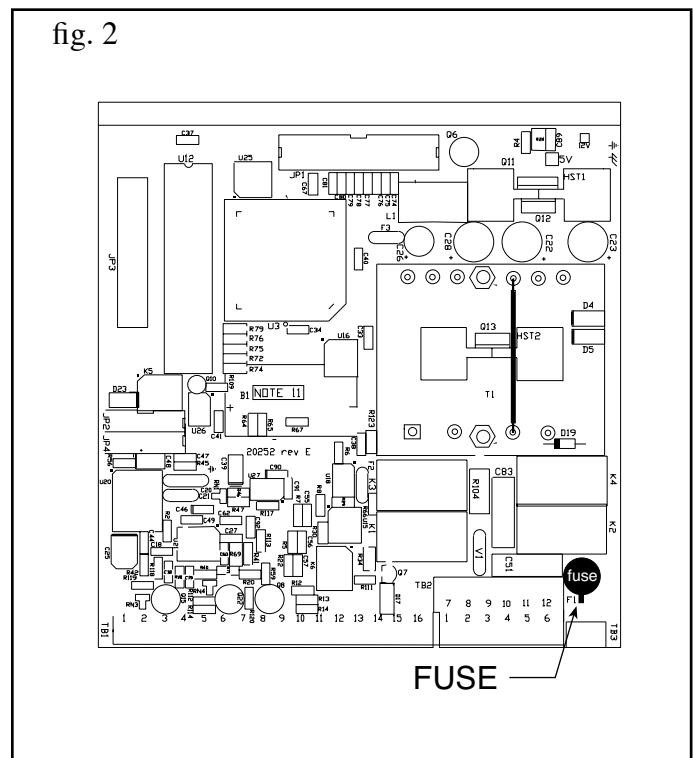
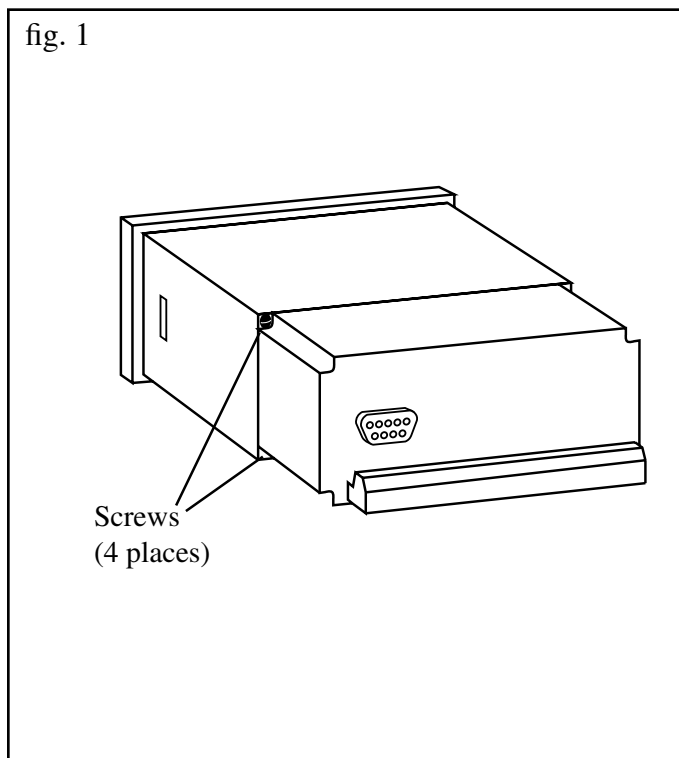

## 9. RS-232 Serial Port

### 9.1 RS-232 Port Description:

The Flow Computer has a general purpose RS-232 Port which may be used for any one of the following purposes:

- Transaction Printing
- Data Logging
- Remote Metering by Modem (optional)
- Computer Communication Link
- Configuration by Computer
- Print System Setup
- Print Calibration/Malfunction History

### 9.2 Instrument Setup by PC's over Serial Port

A Diskette program is provided with the Flow Computer that enables the user to rapidly configure the Flow Computer using a Personal Computer. Included on the diskette are common instrument applications which may be used as a starting point for your application. This permits the user to have an excellent starting point and helps speed the user through the instrument setup.

### 9.3 Operation of Serial Communication Port with Printers

Flow Computer's RS-232 channel supports a number of operating modes. One of these modes is intended to support operation with a printer in metering applications requiring transaction printing, data logging and/or printing of calibration and maintenance reports.

For transaction printing, the user defines the items to be included in the printed document. The user can also select what initiates the transaction print generated as part of the setup of the instrument. The transaction document may be initiated via a front panel key depression, a remote contact closure, or upon completion of a batch.

In data logging, the user defines the items to be included in each data log as a print list. The user can also select when or how often he wishes a data log to be made. This is done during the setup of the instrument as either a time of day or as a time interval between logging.

The system setup and maintenance report list all the instrument setup parameters and usage for the current instrument configuration. In addition, the Audit trail information is presented as well as a status report listing any observed malfunctions which have not been corrected.

The user initiates the printing of this report at a designated point in the menu by pressing the print key on the front panel.

The user may specify a "next calibration date" for periodic maintenance. The unit will automatically remind the user that calibration is scheduled during instrument power up and in some printed documents after that date.

### 9.4 Flow Computer RS-232 Port Pinout

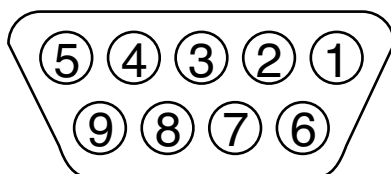

- 1 Printer Handshake Line or DCD In
- 2 Transmit (Out)
- 3 Receive (In)
- 4 N/C or Opt. Modem Power Out (7.5V)
- 5 Ground
- 6 N/C or Opt. Modem Power Out (7.5V)
- 7 RTS (Loop Back To CTS Only)
- 8 CTS (Loop Back To RTS Only)
- 9 N/C (No Connection)

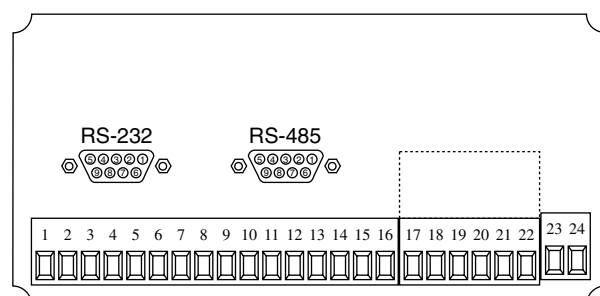

## 10. RS-485 Serial Port (optional)

### 10.1 RS-485 Port Description:

The Flow Computer has a an optional general purpose RS-485 Port which may be used for any one of the following purposes:

Accessing Process Parameters

Rate, Temperatures, Density, Setpoints, Month, Day, Year, Hour, Minutes, Seconds, etc.

Accessing System Alarms

System, Process, Self Test, Service Test Errors

Accessing Totalizers

Totalizer and Grand Totalizer

Executing Various Action Routines

Reset Alarms, Reset Totalizers, Print Transaction, Reset Error History, Start, Stop, Clear

### 10.2 General

The optional RS-485 card utilizes Modbus RTU protocol to access a variety of process parameters and totalizers. In addition, action routines can be executed. For further information, contact factory and request RS-485 Protocol manual for Flow Computer.

### 10.3 Operation of Serial Communication Port with PC

The flow computer's RS-485 channel supports a number of Modbus RTU commands. Refer to port pinout (below) for wiring details. Modbus RTU drivers are available from third party sources for a variety of Man Machine Interface software for IBM compatible PC's.

The user reads and writes information from/to the RS-485 using the Modbus RTU commands. The Flow Computer then responds to these information and command requests.

Process variables and totalizers are read in register pairs in floating point format. Time and date are read as a series of integer register values. Alarms are individually read as coils. Action routines are initiated by writing to coils.

### 10.4 Flow Computer RS-485 Port Pinout

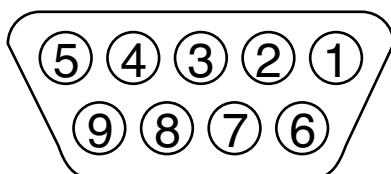

- 1 Ground
- 2 Ground
- 3 Ground
- 4 TX/RX (+)
- 5 TX/RX (-)
- 6 Do Not Use
- 7 Terminating Resistor (180 Ω)
- 8 TX/RX (+)
- 9 TX/RX (-)

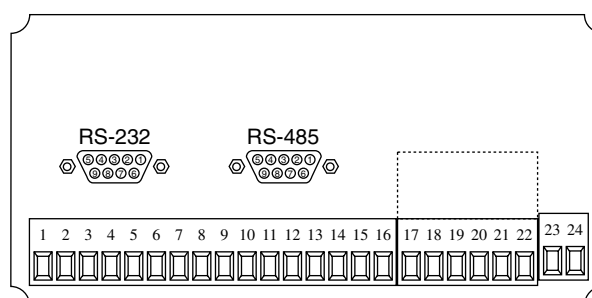

## 11. Flow Computer Setup Software

The Flow Computer setup program provides for configuring, monitoring and controlling a Flow Computer unit.

Sample applications are stored in disk files. The setup program calls these *Templates*. You can store the setup from the program's memory to either the Flow Computer (*Downloading* the file) or to a disk file (*Saving* the file) for later usage. Similarly you can load the setup in program memory from either a disk file (*Opening* a file) or from the Flow Computer unit (*Uploading* a file).

The program can monitor outputs from the unit while it is running.

The program can reset alarms and totalizers.

For assistance there are mini-helps at the bottom of each screen in the program. There is also context sensitive help available for each screen accessible by pressing the F1 key.

### 11.1 System Requirements:

IBM PC or compatible with 386 or higher class microprocessor

4 MB RAM

3 MB free disk space

VGA or higher color monitor at 640 x 480

Microsoft® Windows™ 3.1 or 3.11 or Windows 95™

Communication Port - RS-232

RS-232 Cable

### 11.2 Cable and Wiring Requirements:

The serial communication port on your PC is either a 25 pin or 9 pin connector. No cabling is supplied with the setup software. A cable must be purchased separately or made by the user. It is recommended to purchase a modem cable which matches the available communication port on you PC and a 9 pin male connection for the Flow Computer serial port.

### 11.3 Installation for Windows™ 3.1 or 3.11

The Setup Software includes an installation program which copies the software to your hard drive.

Insert Setup Disk 1 in a floppy drive.

In the Program Manager, click File, and then select Run.

NOTE: For Windows 95™ Click the Start button, select Run and proceed as follows:

Type the floppy drive letter followed by a colon (:), and a backslash (\), and the word setup. For Example:

a:\setup

Follow the instructions on your screen.

## 11.4 Using the Flow Computer Setup Software

The setup software window consists of several menu “Tabs”. Each tab is organized into groups containing various configuration and/or monitoring functions. To view the tab windows, simply click on the tab. The previous tab window will be hidden as the new tab window is brought to the foreground.

## 11.5 File Tab

The File Tab has three sections. Any of the options on this tab can also be accessed from the File submenu.

The **Template Section** provides for opening and saving templates. The *Save* and *Save As* buttons provide the standard Windows functionality for dealing with files. The Load button is used to open existing templates.

There are two additional menu items available *only* from the File menu: Create new file and Templates.

The *Create new file*, option allows for creating custom templates using the existing template in memory as the starting point. Assign a new name for this template. The template will be saved under this new name.

The *Template* option will bring up a list of predefined templates that can be loaded into the program. These predefined templates are useful as a starting point when defining custom templates.

A typical scenario using the setup program would be the following:

- Open up a predefined template from the supplied list
- Choose ‘Save As’ to save this to a new file name
- Proceed to customize the template by making any changes that are needed
- Save the template to disk (if you want to reuse this template)
- Download the template to an attached unit.

The **Communications with Flow Computer Section** allows the user to upload a template file from the unit, download the program’s current template to the unit or Compare the program’s current template with the unit.

The **Print (report) Section** allows the user to:

1. Configure the current Windows printer through the Select Printer option.
2. Print a Maintenance Report through the PC's printer using the Print Maintenance option.
3. Print the current template through the PC's printer using Print Setup option.

## 11.6 Setup Tab

The Setup tab is where majority of the Flow Computer instrument setup modifications are done. The Setup tab is divided into five sections.

**System Section:** Parameters, Display, Indicators

**Input Section:** Flow, Fluid, Compensations, Control Inputs

**Output Section:** Pulse, Currents

**Relay Section:** Relays

**Other Settings Section:** Administration, Communication, Printing

**NOTE:** Many setup items are enabled or disabled depending on previous setup selections, It is important to work your way through the above list in the order shown. Be sure to verify your selections when you are through programming to insure that no settings were changed automatically.



## 11.7 View Tab

The View Tab screen allows for viewing selected group items on the PC in a similar format as shown on the unit display. Data from the following groups can be viewed in the List of Values section:

Process Parameters (i.e. rate, temperature)

Totalizers (i.e. total, grand total)

The setup software assumes the current setup has been uploaded from the flow computer into the PC. It is important that the setup program and the Flow Computer unit are using the same setup information at all times or the data will be inconsistent. It is best to upload or download the setup before using this feature.

To start the viewer, first check the boxes of items to view and then click the start button. The data will appear in the appropriate sections and will be continuously updated. The refresh rate is dependent on the number of items that are being viewed and the baud rate of the connection. Data in the List of Values section can be collapsed by clicking on the 'minus' sign in front of the group title. The data can be expanded by clicking on the 'plus' sign in front of the group title. If a group is collapsed and data in the group changes on refresh, the group will automatically expand. Changing the view items requires stopping the current viewing, checking the new selections and then restarting the viewer.

If communication errors occur while reading data from the Flow Computer device, the word 'Error' will appear in place of the actual value. If the connection to the Flow Computer is lost, the viewer will time out with a message saying the device is not responding.

The viewer will attempt to communicate with the Flow Computer device matching the device ID set in the communications screen. If you are having trouble establishing communication, compare settings for the PC and the flow computer. Also verify the connections between the PC and flow computer.

## 11.8 Misc. Tab

This tab has three sections: Tools, Actions and Options.

The tools section contains various system administration activities such as creating/modifying the initial sign-on screen or calibration, service test etc.

Create Sign-on, Create Print Header, Calibration, Service Test

The Actions section is used to send commands to the unit.

Reset Totalizers, Reset Alarms

The Options section has the following selections:

Linearization, PC Communication

Additional capabilities may be provided in the future.

**NOTE:** Future options appear as disabled buttons on the screen.

## 12. Glossary Of Terms

### Acknowledge & Clear Alarms

Acknowledge is used to clear alarm relays and remove any visual alarm messages from the display. In the run mode, press the ENTER key or activate CONTROL INPUT 3 (if set for *ACK*) to momentarily clear alarms and alarm messages. Alarms will reassert themselves if alarm conditions are still present.

### Analog Output

The analog signal (4-20mA) that is generated by the Flow Computer. It can correspond to the Rate, Total, Temperature or Density. This output is used primarily for transmission of process information to remote systems.

### Audit Trail

The audit trail is used to track the number of changes made to the units setup program.

### Batch Count Mode

Batch Count Mode specifies the user preference for count direction. The "*Up*" selection begins with a value of "0" and counts up until the batch size is reached. The "*Down*" selection begins with a value equal to the desired batch size and counts down to "0".

### Batch Overrun

The Flow Computer offers a batch overrun compensation routine. If batch overrun occurs due to slow valve response time, the unit will compensate for the overrun amount on the next batch. This feature can be disabled if desired.

### Batcher

An instrument which controls the dispensing of desired batch amounts. Liquid batching systems are usually comprised of a batch controller (batcher), flowmeter and control valve. The batcher opens and closes the valve through the use of relays and measures the amounts of liquid being dispensed via the flowmeter.

### Baud Rate

The speed of serial communication transmissions, expressed in bits per second.

### C-Factor (Fluid Expansion Factor)

A parameter in a flow equation which is used to describe the relationship between density or volume and temperature changes.

### Corrected Volume Flow

The equivalently volume at a reference temperature condition which involves the measurement of liquid volume flow using a flow sensor and temperature sensor to compensate for thermal expansion.

### Custody Transfer

Weights and Measure metering codes often specify several requirements for instruments and mechanisms to prevent and track changes in the setup of an instrument which may be used in the commercial sale of goods. The Flow Computer tracks changes via the Audit Trail.

### Data Logger

The capturing of information for later use and the mechanism for specifying the conditions where a capture should be made.

### DC Output / Excitation Voltage

An on-board DC power supply used to power peripheral sensors. The Flow Computer offers excitation voltages of 5VDC, 12VDC or 24VDC when powered by AC voltage.

### Default Value

The value to be used by the instrument if a sensor failure or out of range signal is detected.

### Expansion Factor

See C-Factor

### EZ Preset

The EZ Preset mode was designed for users who frequently change the batch amount.

### Fast Fill Rate

The user specified flow rate for the fast fill portion of a batch cycle when used in batching application with a digital control valve.

### Flow Alarm

A visual indication that the volumetric flowrate is above or below the flow alarm setpoint specified by the user.

## 12. Glossary Of Terms (Continued)

### Flow Signal Timeout

The Flow Signal Timeout allows the user to enter a timeout of 0 to 99 seconds. If a batch is "Filling" and zero flow persists for more than the user entered time then the batch will be aborted. This prevents over flows due to faulty flow sensors and/or wiring.

### Flow Equation

A flow control expression or algorithm describing a mathematical equation to be solved by a flow computer in the desired application.

### Follow, Alarm

Alarm relays which are non latching and whose output state is based solely on the comparison of the current process value and the alarm setpoint (trip point).

### Function Key

A key on a push-button panel or keyboard (whose function is described by the key label) used to perform an instrument function or special routine.

### Handshake

A means of controlling the information flow between two pieces of equipment to prevent the sending device from transmitting information at a rate faster than what can be accepted by the receiver.

### Hysteresis

The relay hysteresis is a "dead band" setting which allows the relay to remain energized for a given amount below the setpoint. This is used to prevent relay chatter when the process value is near the setpoint value.  
Example: If the Preset is set at 100, and the hysteresis is set at 10, the relay will energize when the rate, temp or dens. reaches 100, the relay will remain energized until the reading falls below 90.

### Input Termination

Input signal lines on digital inputs often require pullup or pulldown resistor configurations to operate properly with different sensor configurations. The Flow Computer contains such resistors and may be enabled via the setup menu.

### Inhibit Totalizer

"*Inhibit Total*" is a Control Input 1 setting that is used to stop the totalization. If enabled, a voltage level on control input 1 will inhibit the total as long as the voltage is present. This feature is useful during meter proving and in applications that provide a sensor to signal the flow computer when fluid is present.

### K-Factor

A scaling factor derived from the pulses produced by a flowmeter output, expressed in pulses per unit (i.e. pulses/gallon)

### LCD

Abbreviation for: Liquid Crystal Display

### Limit Setpoint

An alarm trip point setting which specifies the value or magnitude of a process parameter necessary to activate an alarm indicator or control relay.

### Linear Flowmeter

A flow measurement device whose output is proportional to flow.

### Linearization

The mathematical correction of a nonlinear device. The Flow Computer uses a linearization Table which is made up of input/output values and makes interpolations of the table to arrive at a "linearized" measurement.

### LinTbl

Abbreviation for Linearization Table.

### Low Flow Cutoff

A value set at which any flow measurements read below this value will be ignored.

### Low Pass Filter

A low pass filter passes low input frequencies while blocking high frequencies. In the Flow Computer, this is the maximum input count speed to be encountered in an application. It is expressed in counts per second (Hz).

### Mass Flow

Mass Flow is inferred by the volumetric flow and density (or implied density) of a fluid.

## 12. Glossary Of Terms (Continued)

### Maximum Batch Preset

The Maximum Batch Preset allows the user to program the Maximum Batch value allowed to be entered by the operator. If an operator should try to program a batch higher than this value, the unit will not allow the value to be entered and will prompt the user with an error message saying that the Maximum Batch Preset has been exceeded.

### Maximum Drain Time

The unit declares that a batch is "done" when the flow rate equals "0". A flow rate may be present long after the Preset Relay de-energizes due to slow reacting valves or leaky valves. The Maximum Drain Time allows the user to enter an amount of time (0 to 99 seconds) to wait before declaring "Batch Done". After the Preset Batch quantity is reached, the unit will declare "Batch Done" when the flow rate is "0" or the Maximum Drain Time has expired. The batch data will then be available for printing and datalogging.

### Max Window

The max. window time sets the maximum sample time (1 to 99 sec) for the ratemeter.

### Modem Init Master

The "Modem Init Master" menu allows the user to select whether the unit will engage in a configuration conversation with the modem on power up or impart no setup information to the modem and use it "as is". For most users it is recommended to choose "yes" for "Modem Init Master".

### Orifice Plate Flowmeter

A class of flow measurement devices where the measured signal (differential pressure) has a square law relationship to flow.

### Parity

A method for detecting errors in transmissions of serial communications data.

### Preset

A set point used to trigger the relay outputs of the Flow Computer.

### Print Interval

The print interval allows the Flow Computer to transmit information to the serial port at selectable time intervals.

### Private Code

An operator password code which authorizes changes to the setup of the instrument but blocks access to the Service/Calibration/Test mode. The private code also blocks the clearing of the Grand Total.

### Process Parameters

Any sensor information which has been scaled to engineering units including Flow, Temperature and Density.

### Pulldown (Input Termination)

The termination of an input at which the input is pulled down to ground through a resistor. Inputs that are terminated by this method need to be driven high with a positive voltage pulse.

### Pullup (Input Termination)

The termination of an input at which the input is pulled up to a positive voltage through a resistor. Inputs that are terminated by this method need to be pulled low with a sinking current or contact to ground.

### Pulse Output

The pulse output of the Flow Computer is available for remote accumulation of the total or sent to peripheral devices, such as a PLC. The output can be scaled using the Pulse Output Scaling Constant.

### Quad

Abbreviation for Quadrature. Quadrature signals are used for direction control. Two flowmeter signals are output with a 90° phase shift. The counter counts UP when channel A precedes channel B, and counts DOWN when Channel A lags Channel B.

### Quick Setup

A utility that provides for rapid configuration of an instrument. The Flow Computer quick setup provides the following:

- 1) Prompts the user for only critical information.
- 2) Automatically sets specifications to common uses.

After following the Quick Setup procedure, the unit will be operational to perform the basic measurement. The setup can be further customized using the setup menus.

### Quick Update %

This feature is used to disable the rate averaging filter when a significant change in the flow rate occurs. The user can enter the percent of change needed to be detected to disable the averaging feature. This is especially useful during start-up and shutdown of flow.

## 12. Glossary Of Terms (Continued)

### Rate Averaging Filter

The rate averaging filter is used to stabilize fluctuating rate displays. Higher settings provide more averaging for a more stable display. Derived from the equation:  

$$\frac{(\text{OLD DATA} \times \text{"Avg. Filter"} + \text{NEW DATA})}{(\text{"Avg. Filter"} + 1)}$$

### Ratometer

Any device used to display the speed of a process. The ratemeter in the Flow Computer displays flow rate.

### Ref. Dens.

Abbreviation for Reference Density. This is the fluid density at reference temperature.

### Ref. Temp.

Abbreviation for Reference Temperature. This represents the base or reference condition to which corrected flow will be computed.

### Reset/Start Control Input

In a batching system, a single operator activation of the START key or Control Input 1 will reset the total then start the batch process.

### Single\_Pulse

The Single\_Pulse setting is used for flowmeters with single pulse outputs.

### Slow Fill Rate

The user specified flow rate for the slow start of fill and slow end of fill portion of the batching cycle in a batching application with a digital control valve.

### Slow Start Quantity

The Slow Start Quantity is a function that allows an amount to be entered for a Slow Start up. This function requires two stage valve control. RLY 1 (slow flow) will energize for Slow Start and RLY 2 (fast flow) will energize after the Slow Start Quantity has been delivered. This helps reduce turbulence when filling an empty container.

### Sqrt

Abbreviation for Square Root Extraction. Used for flow elements using differential pressure measurements.

### Standard Preset

The Standard Preset mode should be used in applications where the batch amount does not change often.

### Stop/Reset Control Input

In a batching system, a single operator activation of the STOP key or Control Input 2 will stop the batch process then reset the total.

### Time Constant

A damping factor for an averaging filter for the analog output. (see also Rate Averaging Filter)

### Totalizer

Any device which accumulates and displays a total count.

### UVC

Abbreviation for Universal Viscosity Curve. A presentation of the combined flowrate/viscosity calibration for a turbine flowmeter.

### VFD

Abbreviation for Vacuum Fluorescent Display

### Visc Coef

Abbreviation for Viscosity Coefficient. One or more coefficients in an equation used to describe the viscosity as a function of temperature for a fluid.

### Volume Flow

The measurement of volumetric flow.

## 13. Diagnosis and Troubleshooting

### 13.1 Response of Flow Computer on Error or Alarm:

Error and warning indications which occur during operation are indicated in the RUN mode alternately with the measured values. The Flow Computer has three types of error:

TYPE OF ERROR	DESCRIPTION
Sensor/Process Alarms	Errors detected due to sensor failure or process alarm conditions
Self Test Errors	Errors detected during self test.
System Alarms	Errors detected due to system failure

Some alarms are self clearing. Other alarms require the user to acknowledge and clear the alarm. Press the ENTER button to acknowledge and clear alarms. Alarms may reassert themselves if the alarm condition is still present.

**NOTE:** A historical error alarm log is available in the "Test Mode".

The following descriptions suggest possible causes and corrective actions for each alarm message.

### 13.2 Diagnosis Flow Chart and Troubleshooting

All instruments undergo various stages of quality control during production. The last of these stages is a complete calibration carried out on state-of-the-art calibration rigs.

A summary of possible causes is given below to help you identify faults.

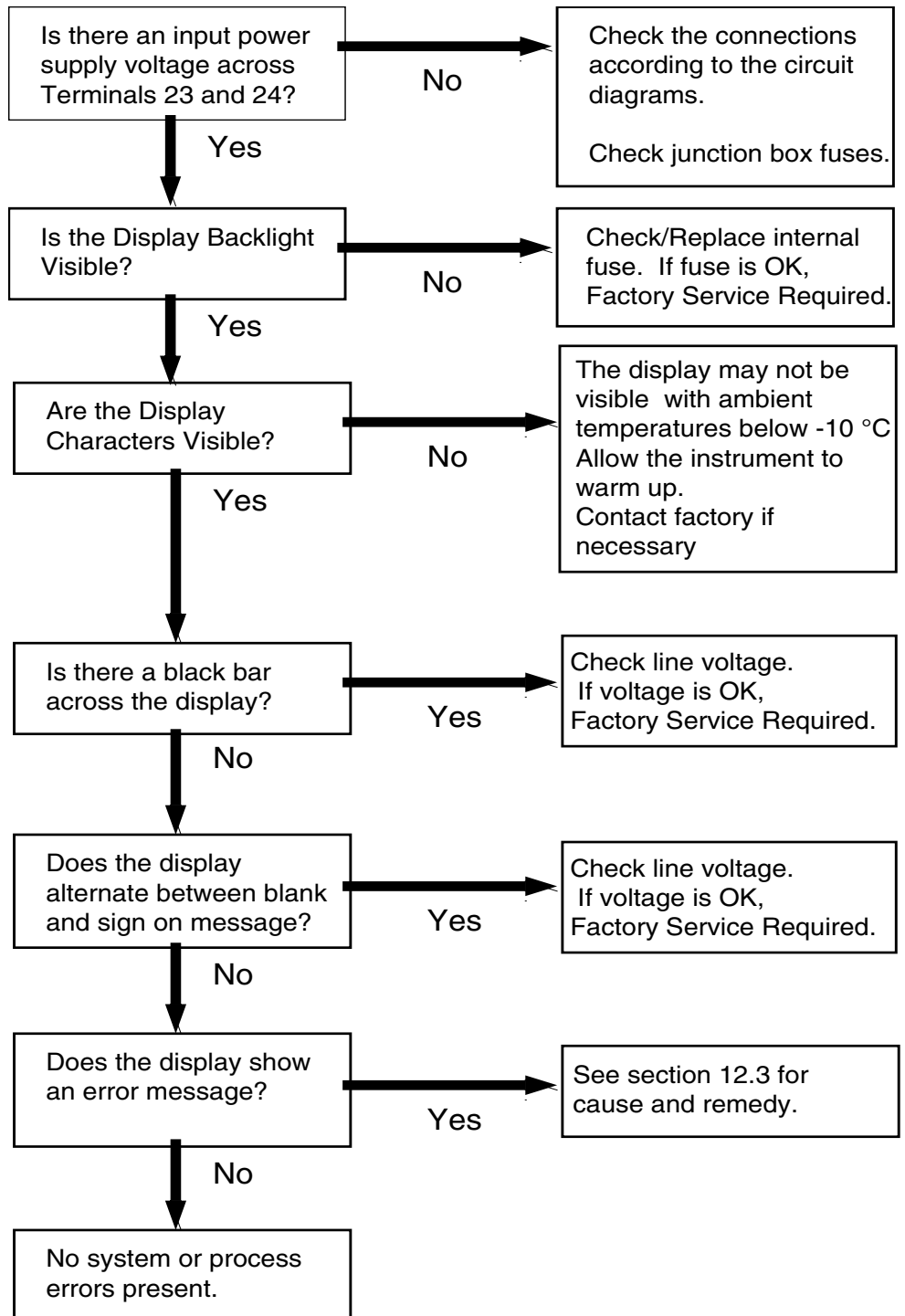

### 13.3 Error & Warning Messages:

#### 13.3.1 Sensor/Process Alarms

Error/Warning Message	Cause	Remedy
<b>TOTALIZER ROLLOVER</b>	Displayed when totalizer rolls over	Acknowledge Rollover, Remedy not required
<b>AUX INPUT TOO LOW</b>	4-20 mA Input current at aux input smaller than 3.5 mA: <ul style="list-style-type: none"> <li>• Faulty Wiring</li> <li>• Transmitter not set to "4-20 mA"</li> <li>• Transmitter defective</li> </ul>	<ul style="list-style-type: none"> <li>• Check wiring</li> <li>• Check function of sensor</li> </ul>
<b>RTD OUT OF RANGE</b>	Input current at RTD input too low: <ul style="list-style-type: none"> <li>• Faulty wiring</li> <li>• RTD defective</li> </ul>	<ul style="list-style-type: none"> <li>• Check wiring</li> <li>• Check function of RTD sensor</li> </ul>
<b>RATE OVERFLOW ERROR</b>	Pulse counter overflowed. The totalizer may have lost counts.	<ul style="list-style-type: none"> <li>• Report error to factory</li> <li>• Check application conditions</li> <li>• Check wiring</li> </ul>
<b>PULSE OUT OVERFLOW</b>	Calculated pulse frequency too large: <ul style="list-style-type: none"> <li>• Pulse width setting too long</li> <li>• Larger pulse scaler needed</li> </ul>	<ul style="list-style-type: none"> <li>• Adjust pulse value</li> <li>• Adjust pulse width</li> <li>• Check process conditions</li> </ul>
<b>FLOW RATE ALARM LOW</b> <b>FLOW RATE ALARM HIGH</b>  <b>TEMP ALARM LOW</b> <b>TEMP ALARM HIGH</b>  <b>DENSITY ALARM LOW</b> <b>DENSITY ALARM HIGH</b>	Limit value exceeded.	<ul style="list-style-type: none"> <li>• Check application if necessary</li> <li>• Check limit value</li> <li>• Adjust the limit value if required</li> </ul>
<b>BATCH OVERRUN ALARM</b>	Batch size exceeded by more than set limit.	<ul style="list-style-type: none"> <li>• Check valves in system for proper operation and/or leaks</li> <li>• Check limit value</li> <li>• Adjust the limit value if required</li> </ul>
<b>MODEM NOT PRESENT</b>	The setup expects modem usage and a modem is not responding.	<ul style="list-style-type: none"> <li>• Check setup for proper baud rate, parity, etc.</li> <li>• Check modem connection and cycle power to Flow Computer</li> <li>• Replace modem</li> </ul>
<b>SOFTWARE ERROR RESET</b>	Watchdog Error. Transient likely	<ul style="list-style-type: none"> <li>• Cycle power to Flow Computer</li> </ul>
<b>EXTENDED PFI LOCKUP</b>	Unit was operated with an input power level lower than safe operating range for an extended period of time.	<ul style="list-style-type: none"> <li>• Check data in unit. Totalizer may have inaccuracies</li> <li>• Investigate brownout cause.</li> </ul>



**13.3 Error & Warning Messages: (Continued)**
**13.3.2  
Self Test Alarms**

<b>Error/Warning Message</b>	<b>Cause</b>	<b>Remedy</b>
<b>FLOW INPUT TOO HIGH</b>	Analog input signal of the flow input exceeded by more than 3%: <ul style="list-style-type: none"> <li>• Sensor overranged</li> <li>• Incorrect full scale setting of flowmeter</li> <li>• Function error in transmitter or faulty wiring</li> </ul>	<ul style="list-style-type: none"> <li>• Check analog signal range</li> <li>• Check the application conditions</li> <li>• Check wiring</li> </ul>
<b>AUX INPUT TOO HIGH</b>	Analog input signal of the auxiliary input exceeded by more than 3%: <ul style="list-style-type: none"> <li>• Sensor overranged</li> <li>• Incorrect full scale setting of transmitter</li> <li>• Function error in transmitter or faulty wiring</li> </ul>	<ul style="list-style-type: none"> <li>• Check analog signal range</li> <li>• Check the application conditions</li> <li>• Check wiring</li> </ul>
<b>FLOW INPUT TOO LOW</b>	Analog input signal of the flow input fell below the low scale range by more than 3% of full scale value: <ul style="list-style-type: none"> <li>• Flowmeter not set to 4-20 mA</li> <li>• Function error in transmitter or faulty wiring</li> </ul>	<ul style="list-style-type: none"> <li>• Check wiring</li> <li>• Check calibration of flowmeter</li> <li>• Check function of flowmeter</li> </ul>
<b>BATTERY LOW WARNING</b>	Battery voltage too low	<ul style="list-style-type: none"> <li>• Replace Battery</li> <li>• Consult Factory for service information</li> </ul>
<b>A to D NOT CONVERTING</b>	Fault in analog/digital converter	<ul style="list-style-type: none"> <li>• Unit may self correct, Press ENTER to acknowledge &amp; clear alarm</li> <li>• If error reasserts, factory service is required</li> </ul>
<b>TIME CLOCK ERROR</b>	The correct time/date is no longer shown	<ul style="list-style-type: none"> <li>• Re-enter time and date.</li> <li>• If error occurs again contact factory</li> </ul>
<b>CAL CHECKSUM ERROR</b>	Calibration constants have been corrupted	<ul style="list-style-type: none"> <li>• Report error to factory</li> </ul>
<b>SETUP CHECKSUM ERROR</b>	The units setup has been corrupted	<ul style="list-style-type: none"> <li>• Report error to factory</li> </ul>

**APPENDIX A - Setup Menus**
**SETUP MENUS**
**START HERE**
**SELECT EZ SETUP**
**INSTRUMENT TYPE**

INSTRUMENT TYPE	SELECT PRESET TYPE	SELECT VALVE TYPE	SLOW FILL RATE	FAST FILL RATE	BATCH COUNT MODE	MAX. BATCH PRESET	BATCH OVERRUN COMP.	AVERAGE OVERRUN VALUE	FLOW SIGNAL TIMEOUT	MAX. DRAIN TIME	SLOW START QUANTITY
-----------------	--------------------	-------------------	----------------	----------------	------------------	-------------------	---------------------	-----------------------	---------------------	-----------------	---------------------

**SELECT FLOW EQUATION**

SELECT FLOW EQUATION
----------------------

**SETUP INDICATORS**

SETUP INDICATORS	TOTAL DESCRIPTOR	VOLUME UNITS	TOTAL DECIMAL PLACES	DENSITY DESCRIPTOR	MASS UNITS	DENSITY DECIMAL PLACES	RATE TIME BASE	RATE DESCRIPTOR	RATE DECIMAL PLACES	RATE AVERAGE FILTER	QUICK UPDATE %	TEMP. DESCRIPTOR	TEMPERATURE SCALE	TEMPERATURE DECIMAL PLACES
------------------	------------------	--------------	----------------------	--------------------	------------	------------------------	----------------	-----------------	---------------------	---------------------	----------------	------------------	-------------------	----------------------------

**SETUP FLOW INPUT**

EXCITATION VOLTAGE
--------------------

FLOW INPUT TYPE	PULSE INPUT TYPE	LOW PASS FILTER	INPUT TERMINATION	MAX WINDOW	K-FACTOR TYPE	AVERAGE K-A FACTOR	AVERAGE K-B FACTOR	CHANGE TABLE A	CHANGE TABLE B	LOW FLOW RATE ALARM	HIGH FLOW RATE ALARM
ANALOG INPUT TYPE	VOLTAGE/CURRENT RANGE	LINEARIZATION TYPE	FLOW LOW SCALE	FLOW HIGH SCALE	CHANGE TABLE A	LOW FLOW CUTOFF	HIGH FLOW RATE ALARM				

**SETUP AUX INPUT**

AUX INPUT TYPE	AUX SIGNAL TYPE	VOLTAGE/CURRENT RANGE	AUX LOW SCALE	AUX FILL SCALE	AUX. DEFAULT	AUX LOW ALARM	AUX HIGH ALARM	DENS. EXTRACT METHOD
----------------	-----------------	-----------------------	---------------	----------------	--------------	---------------	----------------	----------------------

**SET FLUID PROPERTIES**

REF. DENSITY	REF. TEMPERATURE	EXPANSION FACTOR	CALIBRATION DENSITY	VISCOSITY COEF. A	VISCOSITY COEF. B	H <sub>2</sub> O DENSITY AT 4DEGC
--------------	------------------	------------------	---------------------	-------------------	-------------------	-----------------------------------

**SETUP PULSE OUTPUT**

PULSE OUTPUT USAGE	PULSE WIDTH	PULSE VALUE
--------------------	-------------	-------------

**SETUP ANALOG OUTPUT**

ANALOG OUTPUT USAGE	ANALOG OUTPUT FLOW TYPE	RANGE	ANALOG OUT LOW SCALE	ANALOG OUT FULL SCALE	ANALOG OUT DAMPING
---------------------	-------------------------	-------	----------------------	-----------------------	--------------------

**SETUP RELAYS**

SETUP RELAYS 1, 2, 3, 4	RELAY USAGE	RELAY DELAY	RELAY DURATION	RELAY MODE	RELAY SETPOINT	RELAY HYSTERESIS
-------------------------	-------------	-------------	----------------	------------	----------------	------------------

**SETUP CONTROL INPUTS**

SETUP CONTROL INPUTS 1, 2, 3	CONTROL INPUT 1 USAGE	CONTROL INPUT 2 USAGE	CONTROL INPUT 3 USAGE
------------------------------	-----------------------	-----------------------	-----------------------

**SETUP REAL TIME CLOCK**

SETUP REAL TIME CLOCK	CLOCK TYPE	SELECT CLOCK AMPM	TIME OF DAY	ENTER DATE
-----------------------	------------	-------------------	-------------	------------

**SERIAL USAGE**

SERIAL HARDWARE	DEVICE ID	BAUD RATE	PARITY	HANDSHAKE	DEVICE LINE FEED	MODEM CONTROL	MODEM AUTO ANSWER	CALL OUT DAY OF WEEK	CALL OUT TIME	CALL ON ERROR ALARM	CALL OUT PHONE NUMBER	NUMBER OF REDIALS	HANGUP IF 2MIN. INACTIVE
-----------------	-----------	-----------	--------	-----------	------------------	---------------	-------------------	----------------------	---------------	---------------------	-----------------------	-------------------	--------------------------

**SETUP DATALOG/PRINT**

SETUP DATALOG/PRINT	OUTPUT FORMAT	PAGE LENGTH	TOP MARGIN	DATALOG ONLY	PRINT TIME	PRINT INTERVAL	ENABLE PRINT KEY	PRINT END OF BATCH	CLEAR TOTAL IF PRINT	PRINT LIST ITEMS
---------------------	---------------	-------------	------------	--------------	------------	----------------	------------------	--------------------	----------------------	------------------

**ADMINISTRATIVE SETUP**

OPERATOR PASSWORD	TAG NUMBER	SUPERVISOR PASSWORD	SOFTWARE VERSION	PRODUCT ORDER CODE	UNIT SERIAL NUMBER	SENSOR SERIAL NUMBER
-------------------	------------	---------------------	------------------	--------------------	--------------------	----------------------

**SETUP NETWORK CARD**

SELECT NETWORK PROTOCOL	NETWORK DEVICE ID	BAUD RATE	PARITY
-------------------------	-------------------	-----------	--------

These functions will only appear with appropriate settings in other functions.

**APPENDIX B - Batching Diagrams**

Typical Batcher Application with STANDARD Valve(s)

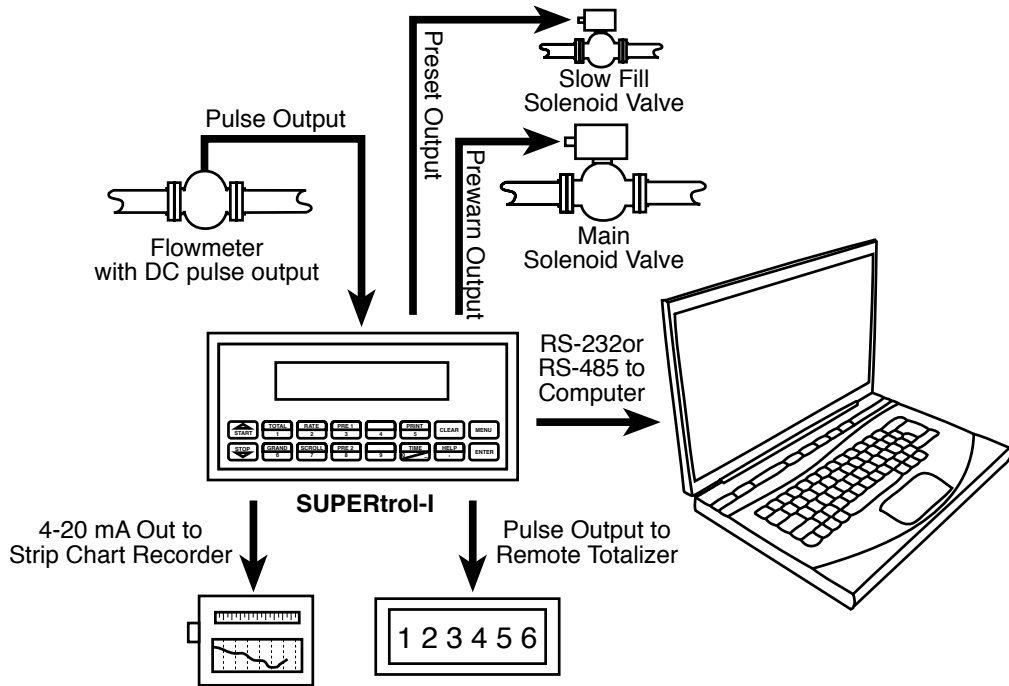

Two Stage vs. Single Stage Batching Illustration with STANDARD Valve(s)

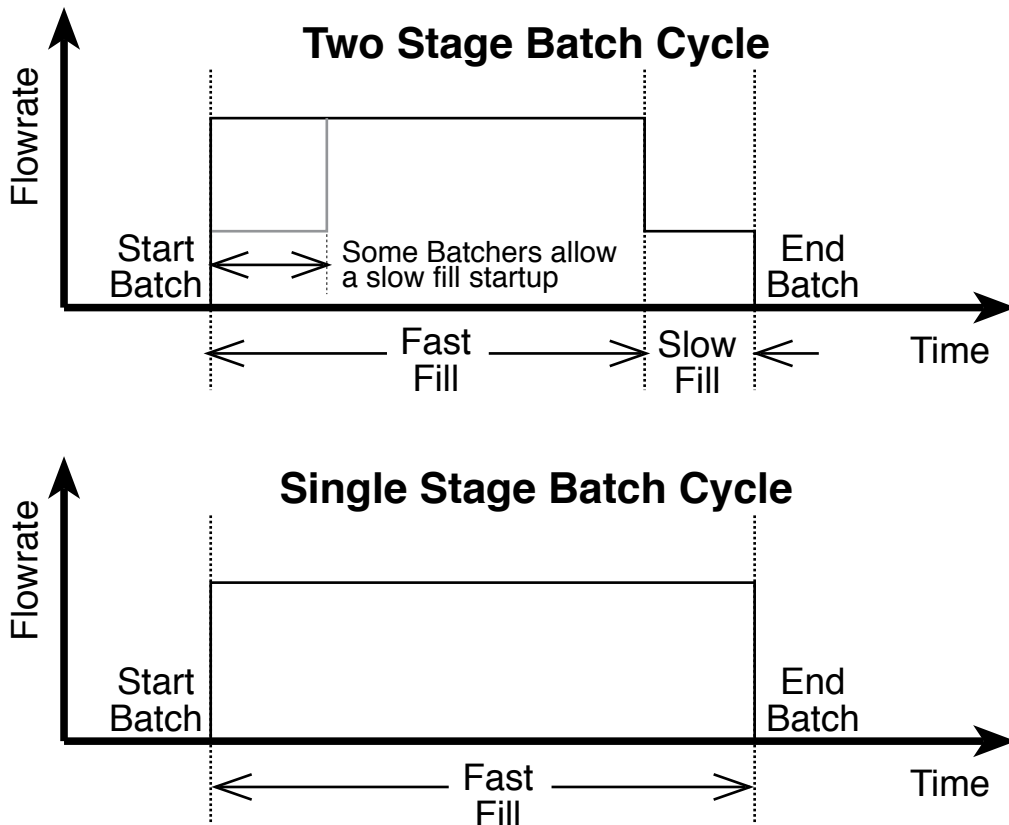

Typical Batcher Application with DIGITAL CONTROL VALVE

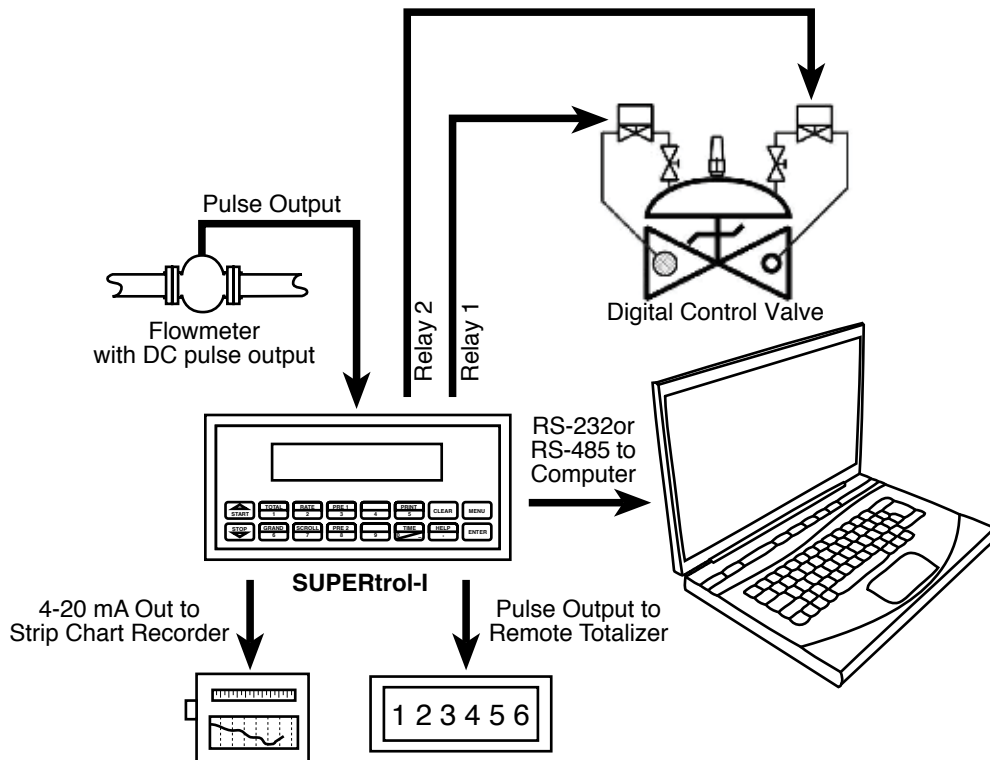

DIGITAL CONTROL VALVE Diagram

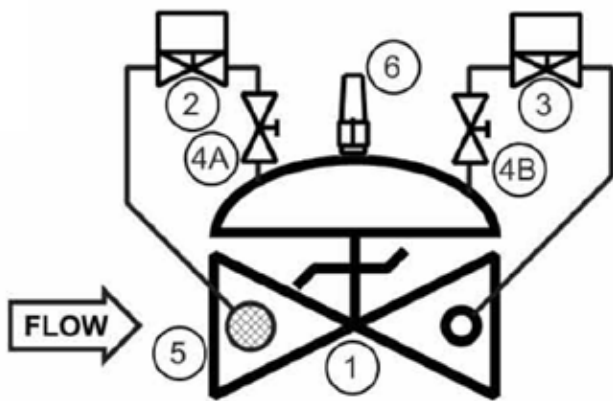

1. Basic Control Valve (Fail Closed)
2. Two-Way Solenoid Pilot (upstream N/O)
3. Two-Way Solenoid Pilot (downstream N/C)
4. Needle Valve
5. Inline Strainer
6. Visual Indicator

ST1 Relay 1	ST1 Relay 2	Function
ON	ON	Opening Valve (increase flow rate)
ON	OFF	Hold Position (maintain flow rate)
OFF	OFF	Closing Valve (reduce flow rate)

DIGITAL CONTROL VALVE Wiring

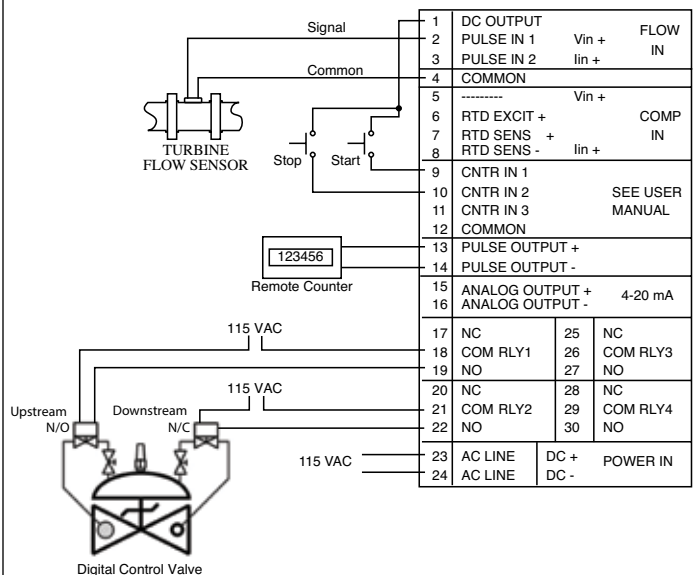

Batch Cycle with Digital Control Valve

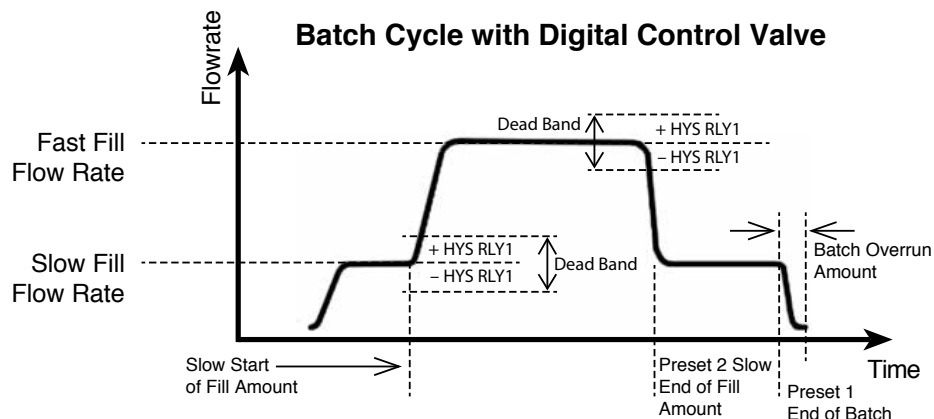

### WARRANTY

This product is warranted against defects in materials and workmanship for a period of two (2) years from the date of shipment to Buyer.

The Warranty is limited to repair or replacement of the defective unit at the option of the manufacturer. This warranty is void if the product has been altered, misused, dismantled, or otherwise abused.

ALL OTHER WARRANTIES, EXPRESSED OR IMPLIED, ARE EXCLUDED, INCLUDING BUT NOT LIMITED TO THE IMPLIED WARRANTIES OF MERCHANTABILITY AND FITNESS FOR A PARTICULAR PURPOSE.

### DECODING PART NUMBER

Example ST1 L 1 A 0 P TU

Series: \_\_\_\_\_  
**ST1**= Supertrol-1

Display Type: \_\_\_\_\_  
**L**= LCD  
**V**= VFD  
**O**= OLED

Input Type: \_\_\_\_\_  
**1**= 110 VAC  
**2**= 220 VAC  
**3**= 12 VDC (10 to 14 VDC)  
**4**= 24 VDC (14 to 28 VDC)

Relays: \_\_\_\_\_  
**A**= 2 SPDT Relays  
**B**= 4 SPDT Relays

Network Card: \_\_\_\_\_  
**0**= None (STD)  
**2**= RS485/Modbus

Mounting: \_\_\_\_\_  
**P**= Panel Mount  
**\*N**= NEMA 4 Wall Mount  
**\*W**= NEMA 12/13 Wall Mount w/ Clear Cover  
**\*E**= Explosion Proof (No Button Access)

Options: \_\_\_\_\_  
**ET**= Extended Tempertaure  
 -4°F to 131°F (-20°C to 55°C)  
**IM**= IM-2400 Internal Modem  
**IM-56K**= 56K Internal Secure Modem  
**M**= Modem Power Option  
**TB**= RS485 Terminal Block  
 for Panel Mount Enclosure

Accessories:  
 OPC/DDE Server for RS232 Port (superseded by KEPS-KEP1-32)  
 OPC/DDE Server for Modbus Suite (superseded by KEPS-MBS32)  
 Modem Available, see MPP-56KN, MPP-2400 and MPP-2400N  
 Serial printer available, see P1000, P295  
 Ethernet Port Server available, see IEPS  
 RS-422/485 to RS-232 Communication Adaptor available, see CA285  
 RS232 Extender Cable: P/N=13220-<length in inches>  
 Remote metering and data collection software available, (TROLLink)

**RoHS Compliant planned**

## **Kessler-Ellis Products**

10 Industrial Way East  
 Eatontown, NJ 07724

Toll Free: 800-631-2165

Phone: (732) 935-1320

Fax: (732) 935-9344

<http://www.kep.com>