

P20 Printer

User's Manual

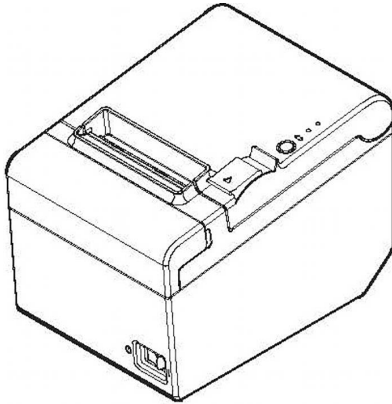

KESSLER-ELLIS PRODUCTS

10 Industrial Way East

Eatontown, NJ 07724

800-631-2165 • 732-935-1320

Fax: 732-935-9344

kep.com
<http://www.kep.com>



Important Safety Information

This section presents important information intended to ensure safe and effective use of this product. Read this section carefully and store it in an accessible location.

Key to Symbols

The symbols in this manual are identified by their level of importance, as defined below. Read the following carefully before handling the product.



WARNING:

Warnings must be followed carefully to avoid serious bodily injury.



CAUTION:

Cautions must be observed to avoid minor injury to yourself damage to your equipment, or loss of data.



Note:

Notes have important information and useful tips on the operation of your equipment.

Safety Precautions



WARNING:

Shut down your equipment immediately if it produces smoke, a strange odor, or unusual noise. Continued use may lead to fire or shock. Immediately unplug the equipment and contact your dealer or a service center for advice. Never attempt to repair this product yourself. Improper repair work can be dangerous.

Never disassemble or modify this product. Tampering with this product may result in injury, fire, or shock.

Be sure to use the specified power source. Connection to an improper power source may cause fire.

Never insert or disconnect the power plug with wet hands. Doing so may result in severe shock.

Do not place multiple loads on the power outlet (wall outlet). Always supply power directly from a standard power outlet. Overloading the outlet may lead to fire.

Be sure your power cord meets the relevant safety standards and includes a power-system ground terminal (PE terminal). Otherwise shock may result. Handle the cables with care. Improper handling may lead to fire or shock.

- Do not use the cables if they are damaged.

- Do not modify or attempt to repair the cables.

- Do not place any object on top of the cables.

- Avoid excessive bending, twisting, and pulling of the cables.

- Do not place cables near heating equipment.

- Check that the plug is clean before plugging it in.

- Check that the AC inlet is clean before plugging the power connector in it.

- Be sure to push the prongs and power connector all the way in.

Use the provided power cable only. Do not use the provided power cable with any other devices than the specified one. Doing so may lead to fire or shock.

Never glue the AC inlet and the power cable together.

Regularly remove the power plug from the outlet and clean the base of the prongs and between the prongs. If you leave the power plug in the outlet for a long time, dust may collect on the base of the prongs, causing a short and fire. Regularly confirm that the plug and AC inlet are not wet with liquid such as water.

Do not allow foreign matter to fall into the equipment. Penetration by foreign objects may lead to fire.

If water or other liquid spills into this equipment, unplug the power cord immediately, and then contact your dealer or a service center for advice. Continued usage may lead to fire.

Do not use aerosol sprayers containing flammable gas inside or around this product. Doing so may cause fire.

Do not connect a telephone line to the drawer kick-out connector: otherwise the printer and the telephone line may be damaged.



CAUTION:

Do not connect cables in ways other than those mentioned in this manual. Different connections may cause equipment damage and burning. Be sure to set this equipment on a firm, stable, horizontal surface. The product may break or cause injury if it falls.

Do not use in locations subject to high humidity or dust levels. Excessive humidity and dust may cause equipment damage or fire.

Do not place heavy objects on top of this product. Never stand or lean on this product. Equipment may fall or collapse, causing breakage and possible injury. Take care not to injure your fingers on the manual cutter.

When you remove printed paper

When you perform other operations such as loading/replacing roll paper

To ensure safety, unplug this product before leaving it unused for an extended period.

Caution Labels

The caution labels on the product indicate the following precautions.



CAUTION:

Do not touch the thermal head because it can be very hot after printing.

Restriction of Use

When this product is used for applications requiring high reliability /safety, such as transportation devices related to aviation, rail, marine, automotive, etc.; disaster prevention devices; various safety devices, etc.; or functional/precision devices, etc.; you should use this product only after giving consideration to including fail-safes and redundancies into your design to maintain safety and total system reliability. Because this product was not intended for use in applications requiring extremely high reliability /safety, such as aerospace equipment, main communication equipment, nuclear power control equipment, or medical equipment related to direct medical care, etc., please make your own judgment on this product's suitability after a full evaluation.

Unpacking

The following items are included with the standard specification printer.
If any item is damaged, contact your dealer.

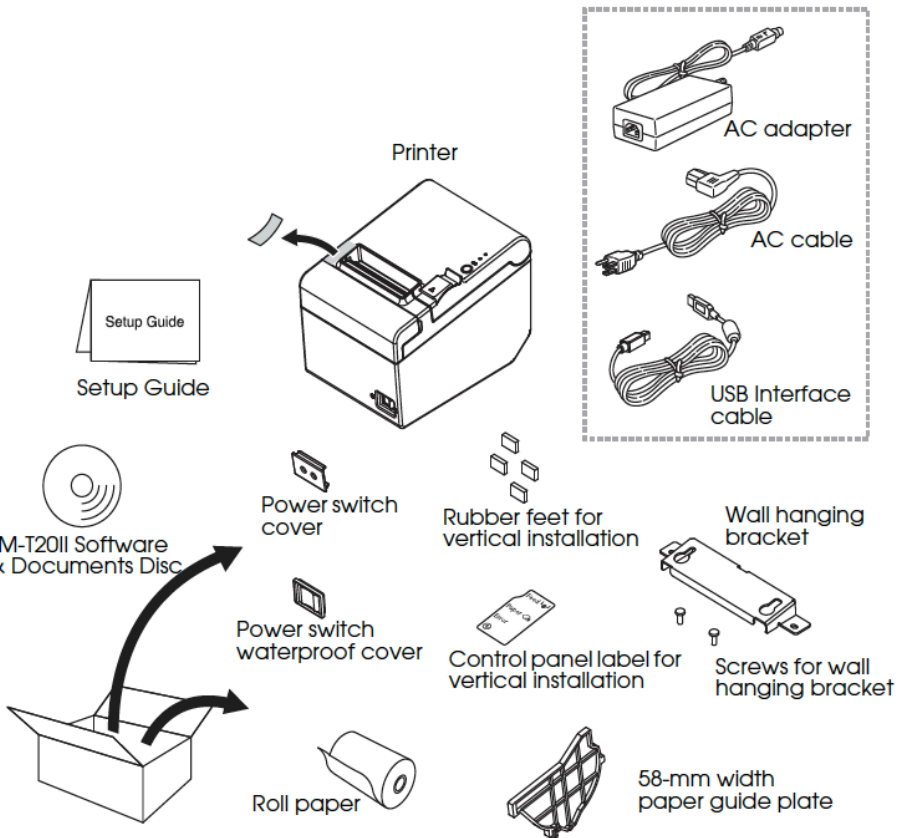

Part Names

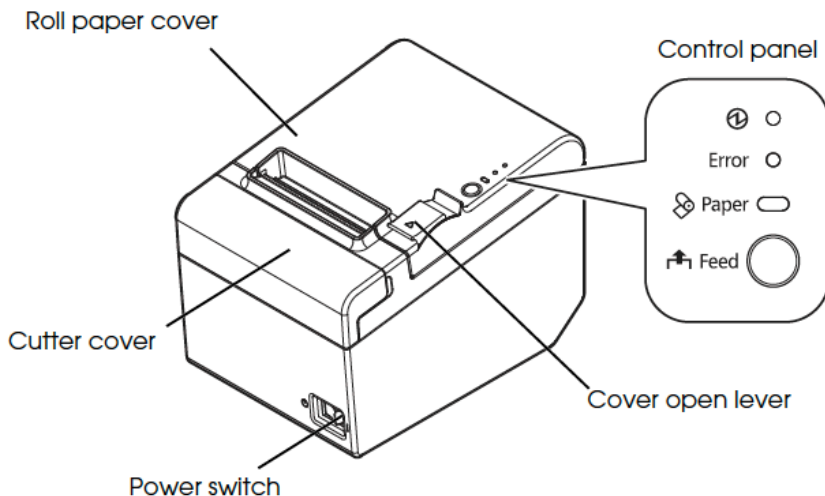

Control Panel

Ⓜ (Power) LED

This LED is on when the printer is on.

Error LED

This indicates an error.

Paper LED

On indicates a paper out. Flashing indicates standby.

Feed button

This button feeds paper.

Connecting the Cables

CAUTION:

For a serial interface, use a null modem cable.

For a USB interface, do not turn on the printer before installing the printer driver. Do not connect to electrical outlets close to devices that generate voltage fluctuations or electrical noise. In particular, stay clear of devices that use large electric motors.

Never attempt to stretch the cables to enable a connection. The power cable must have adequate slack at all times during use.

1. Make sure the printer is turned off.
2. Connect the interface cable to the printer.
For the shape of each connector, see the illustration below. (Mounted interfaces vary by the printer model.)

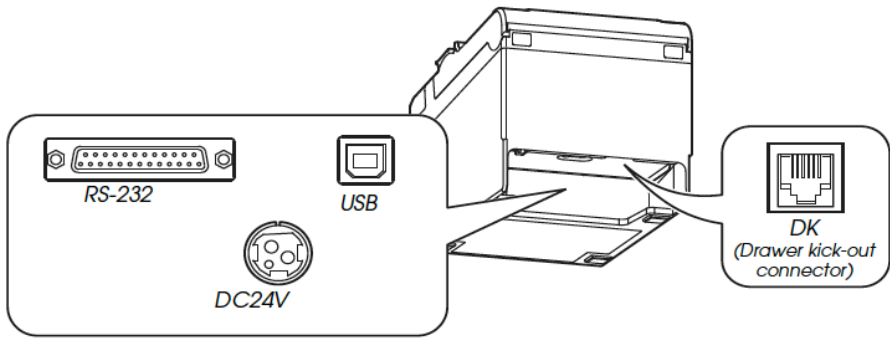

Note:

When connecting the USB cable, fix the USB cable with the hook shown in the illustration below to prevent the cable from coming off.

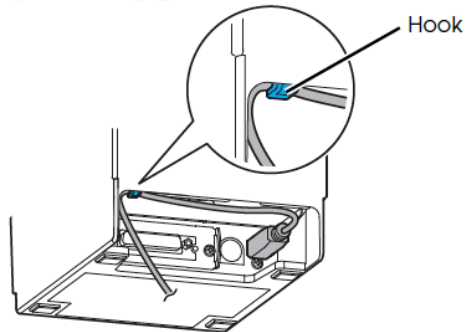

3. Connect the interface cable to the computer.
4. Connect the AC cable to the AC adapter.

5. Connect the DC cable of the AC adapter to the power connector of the printer.

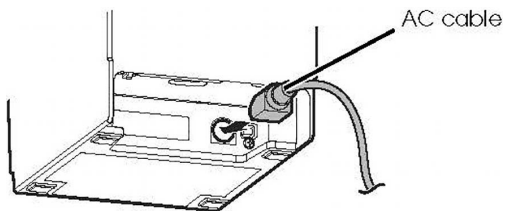

6. Insert the AC plug into a power outlet.

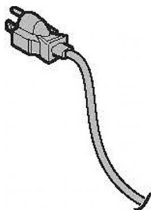

Serial Port Connectors

25 pin D-SUB male connector at printer

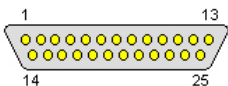

| Printer Pin Number | Printer Pin Name |
|--------------------|------------------|
| 2 | TXD |
| 3 | RXD |
| 6 | DSR |
| 7 | Ground |
| 20 | DTR |
| 5 | CTS |
| 4 | RTS |

9 pin D-SUB female connector at KEP flow computer (FC)

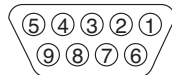

| FC Pin Number | FC Pin Name |
|---------------|-------------|
| 2 | TXD |
| 3 | RXD |
| 5 | Ground |
| 7 | RTS |

2. MODE SELECTION: Press and hold FEED button to enter Mode Selection

```
Mode Selection
Modes
0: Exit and Reboot Printer
1: NV Graphics Information
2: Receipt Enhancement Information
3: Customize Value Settings
4 or more: None
```

Select Modes by executing following procedure.

- step 1. Press the Feed button less than 1 second as many times as the selected mode number.
- step 2. Press Feed button for 1 second or more.

3. CUSTOMIZE VALUE SELECTION: Do three quick followed by a long depression to enter CUSTOMIZE VALUE SELECTION

```
Customize Value Settings
Modes
0: Exit
1: Print Current Settings
2: Print Density
3: Printing Speed
4: Serial Interface Settings
5: Auto Paper Feed&Cut at cover close
6: Paper Width
8: Default Character
9: Embedded Font Replacement
10: USB Interface Settings
11: Buzzer Control
12: Column Emulation
13: Interface Settings
15: Logo Emulation
16: Automatic Paper Reduction
17: Interface Selection
18: Power Supply Unit Capacity
```

Select Modes by executing following procedure.

- step 1. Press the Feed button less than 1 second as many times as the selected mode number.
- step 2. Press Feed button for 1 second or more.

4. SERIAL INTERFACE SETTINGS: Do 4 quick depressions to enter Selection 4: SERIAL INTERFACE SETTINGS

```
4.Serial Interface Settings
Modes
0: Return to the previous menu
1: Baud Rate
2: Parity
3: Handshaking
4: Data Bits
5: Data Receive Error
```



Note:

You can then work your way through the Baud Rate and other settings one by one each time returning to the SERIAL INTERFACE SETTING selection where you can then select the next item to be configured (next Parity, then Handshaking, then Data Bits, then Data Receive Error)

5. BAUD RATE: Do 1 quick depression followed by long depression to enter Baud Rate. Do the same number of quick depressions as the number assigned to the desired Baud Rate (i.e. 3 quick for 4800)

```
4.Serial Interface Settings
4.1.Baud Rate
Modes
0: Return to the previous menu
1: 2400bps
2: 4800bps
* 3: 9600bps
4: 19200bps
1 5: 38400bps
6: 57600bps
7: 115200bps
] means default value.
* means current set value.
```

6. PARITY: Do 2 quick depressions followed by long depression to enter Parity. Do the same number of quick depressions as the number assigned to the desired Parity (i.e. 3 quick for Even)

| | |
|------------------------------------------------------------------------------------------------------------------------------------------------------|------------------------------------------------------------------------------------------------------------------------------------------------------------------|
| <pre>4.Serial Interface Settings Modes 0: Return to the previous menu 1: Baud Rate 2: Parity 3: Handshaking 4: Data Bits 5: Data Receive Error</pre> | <pre>4.Serial Interface Settings 4.2.Parity Modes 0: Return to the previous menu]#: None 2: Odd 3: Even] means default value. * means current set value.</pre> |
|------------------------------------------------------------------------------------------------------------------------------------------------------|------------------------------------------------------------------------------------------------------------------------------------------------------------------|

7. HANDSHAKING: Do 3 quick depressions followed by long depression to enter Handshaking. Do the same number of quick depressions as the number assigned to the desired Parity (i.e. 2 quick for XON/XOFF)

| | |
|------------------------------------------------------------------------------------------------------------------------------------------------------|-----------------------------------------------------------------------------------------------------------------------------------------------------------------------|
| <pre>4.Serial Interface Settings Modes 0: Return to the previous menu 1: Baud Rate 2: Parity 3: Handshaking 4: Data Bits 5: Data Receive Error</pre> | <pre>4.Serial Interface Settings 4.3.Handshaking Modes 0: Return to the previous menu]#: DTR/DSR 2: XON/XOFF] means default value. * means current set value.</pre> |
|------------------------------------------------------------------------------------------------------------------------------------------------------|-----------------------------------------------------------------------------------------------------------------------------------------------------------------------|

8. DATA BITS: Do 4 quick depressions followed by long depression to enter Data Bits. Do the same number of quick depressions as the number assigned to the desired Data Bits (i.e. 1 quick for 7 bits)

| | |
|------------------------------------------------------------------------------------------------------------------------------------------------------|------------------------------------------------------------------------------------------------------------------------------------------------------------------|
| <pre>4.Serial Interface Settings Modes 0: Return to the previous menu 1: Baud Rate 2: Parity 3: Handshaking 4: Data Bits 5: Data Receive Error</pre> | <pre>4.Serial Interface Settings 4.4.Data Bits Modes 0: Return to the previous menu 1: 7 bits]#: 8 bits] means default value. * means current set value.</pre> |
|------------------------------------------------------------------------------------------------------------------------------------------------------|------------------------------------------------------------------------------------------------------------------------------------------------------------------|

9. DATA RECEIVE ERROR: Do 5 quick depressions followed by long depression to enter Data Receive Error. Do the same number of quick depressions as the number assigned to the desired Data Receive Error (i.e. 2 quick for Ignored)

| | |
|------------------------------------------------------------------------------------------------------------------------------------------------------|-------------------------------------------------------------------------------------------------------------------------------------------------------------------------------|
| <pre>4.Serial Interface Settings Modes 0: Return to the previous menu 1: Baud Rate 2: Parity 3: Handshaking 4: Data Bits 5: Data Receive Error</pre> | <pre>4.Serial Interface Settings 4.5.Data Receive Error Modes 0: Return to the previous menu]#: Print "?" 2: Ignored] means default value. * means current set value.</pre> |
|------------------------------------------------------------------------------------------------------------------------------------------------------|-------------------------------------------------------------------------------------------------------------------------------------------------------------------------------|

9. EXIT SERIAL INTERFACE SETUP: Do one long depression of FEED button to exit Serial Interface Setup. Do this again 2 times to exit setup and reboot printer.

```
4.Serial Interface Settings
Modes
0: Return to the previous menu
1: Baud Rate
2: Parity
3: Handshaking
4: Data Bits
5: Data Receive Error
```

Installing the Printer

You can install the printer horizontally on a flat surface (with the paper exit on top) or vertically (with the paper exit at the front). Also, you can hang it on a wall using the included accessories.



CAUTION:

Take measures to prevent the printer from moving by vibration during paper cutting and when using a drawer. Affixing tape is provided as an option.

Installing the Printer Vertically

When installing the printer vertically, be sure to attach the included control panel label for vertical installation on the roll paper cover, and attach 4 rubber feet in the rectangular indents in the printer case, as shown in the illustration below.

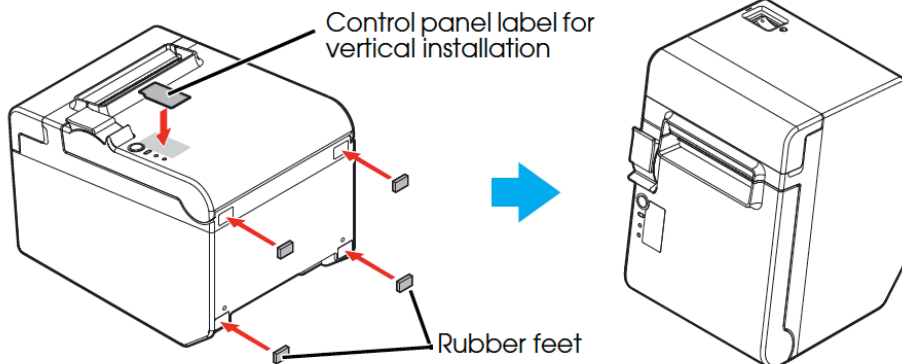



Note:

You can install the printer so that the roll paper cover is upright to the mounting surface using the included wall hanging bracket.

1. Attach the control panel label for vertical installation on the roll paper cover.
2. Install the wall hanging bracket on the printer, and fix it using 2 included screws.
3. Attach 2 rubber feet in the rectangular indents in the printer case, and attach 2 rubber feet within the scribed line on the hanging bracket.
4. Place the printer with the wall-hanging-bracket-side down.

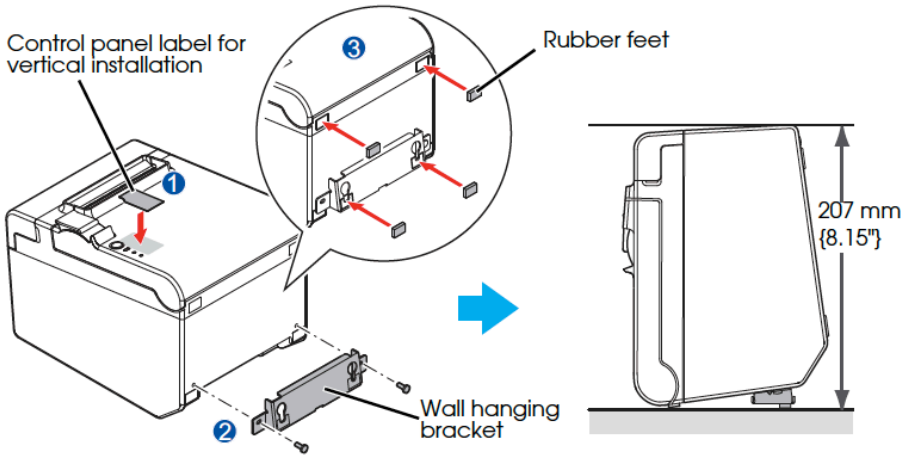

Hanging the Printer on a Wall

To hang the printer on the wall, follow the steps below.



CAUTION:

To fix the printer securely, install the wall hanging bracket on a wall made of wood, concrete, or metal. The thickness of the wall should be 70 mm {0.4"} or more.

Be sure to use metallic screws.

The screws on the wall side must have a pull-out strength of 750 N (75.3 kgt) or more.

1. Install 2 screws (screw diameter: 4 mm {0.16"}, head diameter: 7 to 9 mm {0.28 to 0.35"}) in the wall at an interval of 80 mm {3.15"}. Make sure the length of the screw's body in the wall is 10 mm {0.39"} or more, and the length outside the wall is 3 to 4 mm {0.12 to 0.16"}.

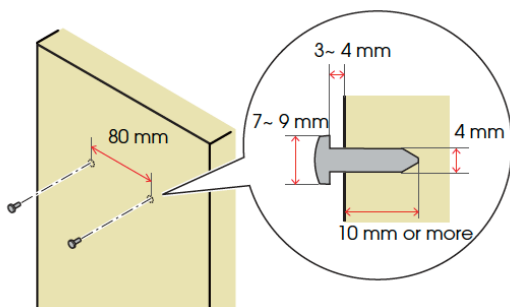

2. Remove the installed 2 screws from the printer, as shown in the illustration below.
3. Install the wall hanging bracket on the printer, and fix it using the screws removed in Step 2.

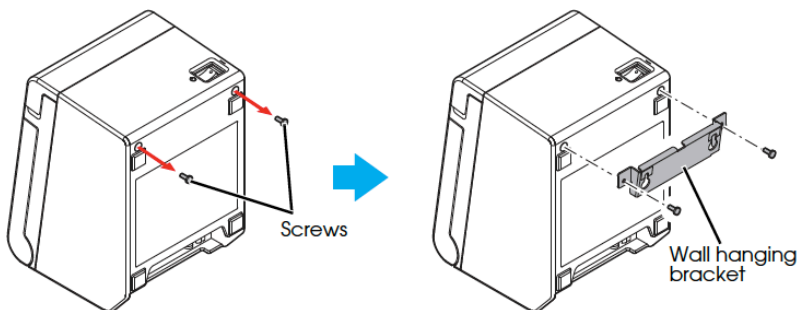

4. Align the holes in the wall hanging bracket with the screws on the wall, and hook it securely.

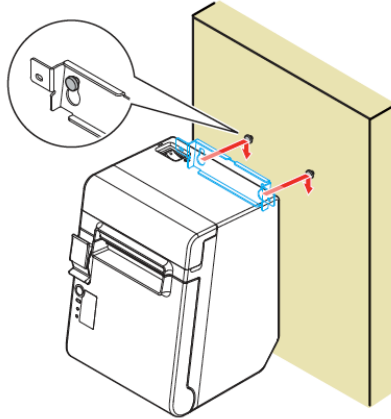

Installing Roll Paper

Follow the steps below to install the roll paper.

1. Use the cover open lever to open the roll paper cover.

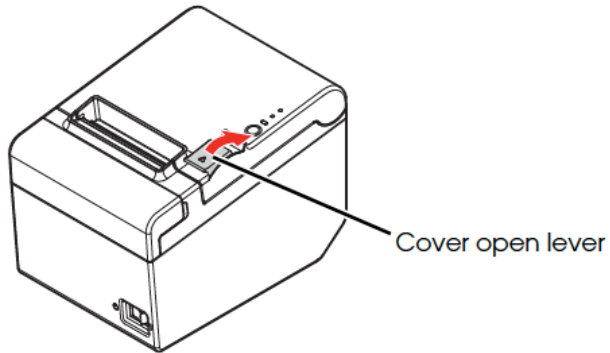

2. Remove the used roll paper core if any, and insert the roll paper. The correct direction of the paper is shown in the illustration below.

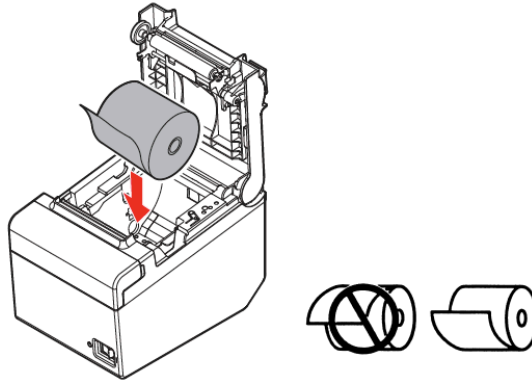

3. Pull out some paper, and close the roll paper cover.
When the printer power is on, the roll paper is automatically cut.

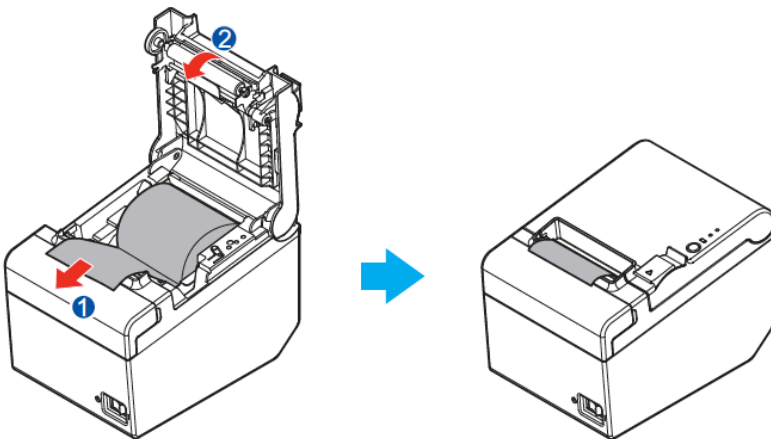

Changing the Paper Width

You can change the paper width from 80 to 58 mm by installing the included 58-mm width paper guide plate. Follow the steps below to change the paper width.



CAUTION:

Once you change the paper width from 80 to 58 mm, you cannot change it back to 80 mm,

When changing the paper width, be sure to make the setting for the paper width with the utility software for the TM-T201/.

1. Open the roll paper cover.
2. Align 3 projections on the 58-mm width paper guide plate with the rectangular holes in the printer, and push it downwards.

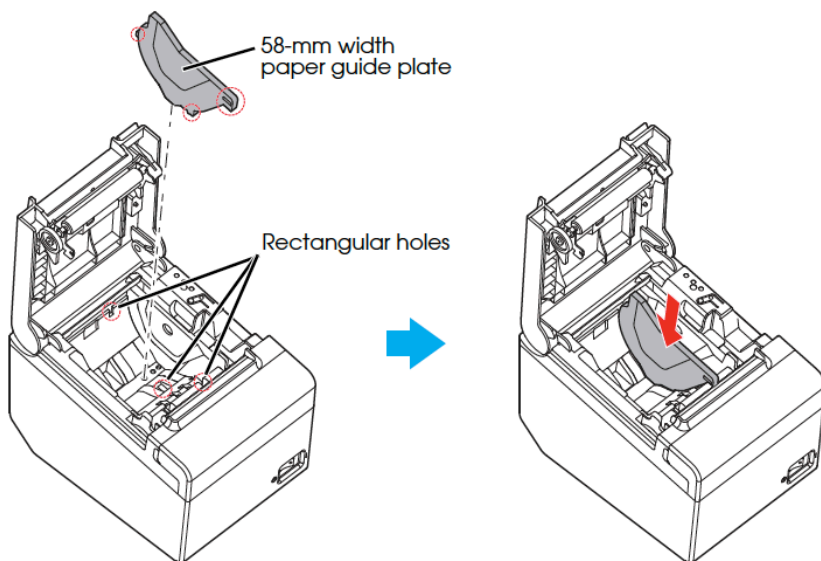

3. Install the roll paper.
4. Close the roll paper cover.

Attaching Cover on the Power Switch

The enclosed power switch cover ensures that the power switch is not pressed accidentally.

You can turn the power switch on and off by inserting a sharp-pointed object in the holes in the power switch cover. To detach the cover, also use a sharp-pointed object.

A waterproof cover for the power switch is also included.

To use these covers, install them as shown in the illustration below.



WARNING:

If an accident occurs with the power switch cover attached, unplug the power cord immediately. Continued use may cause fire or shock.

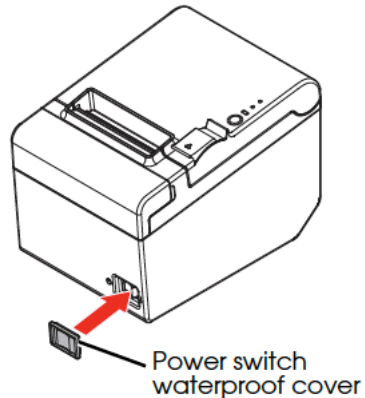
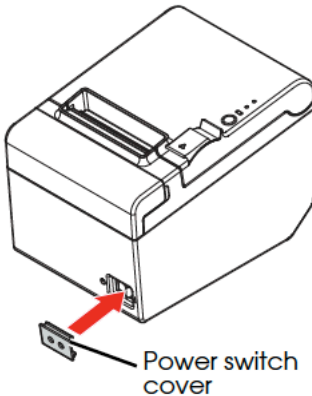

Troubleshooting

No lights on the control panel

Check whether the power supply cable is correctly connected to the printer and the socket.

Error LED on with no printing

- Check whether the roll paper cover is closed. If it is open, close it.
- If the Paper LED is on, check whether the roll paper is correctly installed and any roll paper remains.

Error LED flashing with no printing

- Check whether a paper jam has occurred. If paper is jammed, remove the jammed paper referring to the description below and install the roll paper correctly.
- Printing stops if the head overheats and resumes automatically when it cools.
- For other cases, turn the printer off, and after 10 seconds, back on.

When a paper jam occurs

When a paper jam occurs, never pull out the paper forcibly. Open the roll paper cover and remove the jammed paper.



CAUTION:

Do not touch the thermal head, because it can be very hot after printing.

If the roll paper cover does not open, follow the steps below.

1. Turn off the printer.
2. Put the fingers in the indents in both sides of the cutter cover, and slide it toward the arrow in the illustration below to remove it.

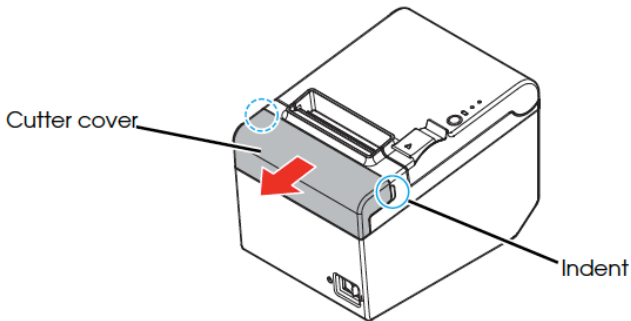

3. Turn the knob until you see a triangle in the opening. This returns the cutter blade to the normal position. See the operating instructions on the back of the cutter cover.

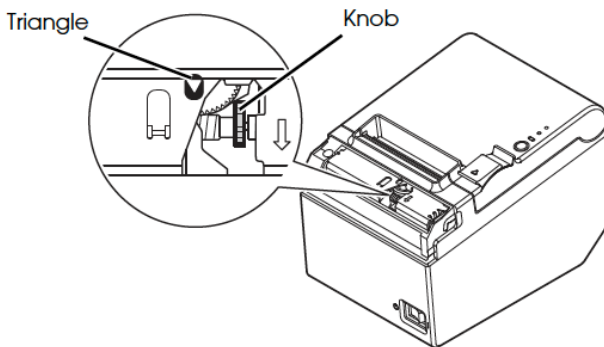

4. Install the cutter cover.
5. Open the roll paper cover and remove the jammed paper.

Cleaning

Cleaning the Printer Case

Be sure to turn off the printer, and wipe the dirt off the printer case with a dry cloth or a damp cloth.



CAUTION:

Never clean the product with alcohol benzine, thinner, or other such solvents. Doing so may damage or break the parts made of plastic and rubber.

Cleaning the Thermal Head



CAUTION:

After printing, the thermal head can be very hot. Be careful not to touch it and to let it cool before you clean it.

Do not damage the thermal head by touching it with your fingers or any hard object.

Turn off the printer, open the roll paper cover, and clean the thermal elements of the thermal head with a cotton swab moistened with an alcohol solvent (ethanol or IPA).

We recommend cleaning the thermal head periodically (generally every 3 months) to maintain receipt print quality.

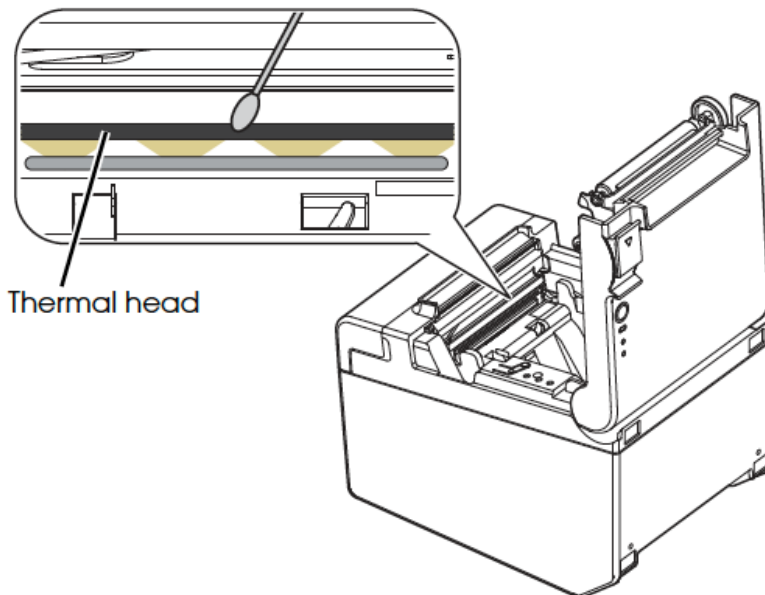

Specifications

| | |
|---------------------------|-----------------------------------------------------------------------------------------------------------------------------------------------------------------------------------------------------------------------------------------------------------------------------------|
| Print method | Thermal line printing |
| Print speed | Max. 200mm/sec (5.91 in/sec) |
| Print font | |
| Font | 9 x 17 and 12 x 24 dots/character (W x H) |
| Column capacity | Standard: Paper width 80mm: 48/64; Paper width 58mm: 35/46 42 Column Mode: Paper width 80mm: 42/60; Paper width 58mm: 42/31 |
| Character size | 0.88 × 2.13 and 1.25 × 3 mm (W x H) |
| Character set | 95 Alphanumeric, 18 set International, 128 × 43 Graphic. Barcode: UPC-A, UPC-E, JAN13 (EAN13), JAN8 (EAN), CODE39, ITF, CODABAR (NW-7), CODE93, CODE128, GS1-128, GS1 DataBar. Two-dimensional code: PDF417, QRCode, MaxiCode, 2D GS1 DataBar, Composite Symbology |
| Characters per inch | 22.6 and 16.9 cpi |
| Paper dimensions | 80mm: 3.13" ± 0.02" x 3.27" diameter (79.5 ± 0.5(W) x 83mm) 58mm: 2.26" ± 0.02" x 3.27" diameter (57.5 ± 0.5(W) x 83mm) |
| Reliability | |
| MTBF | 360,000 hours |
| MCBF | 60,000,000 lines |
| Interface | Serial, RS-232, DB25F |
| Serial Interface Settings | |
| Baud Rate | 2400bps, 4800bps, 9600bps, 19200bps, 38400bps, 57600bps, 115200bps |
| Parity | None, Odd, Even |
| Handshaking | DTR/DSR, XON/XOFF |
| Data Bits | 7 bits, 8 bits |
| Data Receive Error | Print "?", Ignored |
| Power | 100 – 240V AC, 50/60 Hz |
| Power consumption | Approx. 1.8A |
| Power supply | External (AC cable included) |
| D.K.D. function | 2 drivers |
| Overall dimensions | 5.51" x 7.83" x 5.75" (140 x 199 x 146 mm) (W x D x H) |
| Mass | 3.75lb (1.7 kg) |
| Color | Dark Gray |
| Safety standards | UL/CSA/EN/TUV/GOST-R |
| Installation | Horizontal/vertical on counter/vertical on wall with wall hanging bracket |
| Temperature/Humidity | |
| Operating | 5 to 45°C {41 to 113°F}, 10 to 90% RH |
| Storage | -10 to 50°C {14 to 122°F}, 10 to 90% RH (except for paper) |
| Installation | For indoor use only |

Default Delay Times for Power Management

This product will enter low power (sleep) mode after a period of nonuse. The time interval has been set at the factory to ensure that the product meets Energy Star standards of energy efficiency and cannot be modified by the consumer.

The power consumption in the sleep mode and power off mode is described below.

| | | USB model | Serial model | Ethernet model |
|----------------------|-----------------------|------------------|---------------------|-----------------------|
| AC 230V/50 Hz | Sleep mode | 1.2 W | 0.91 W | 2.7 W |
| | Power off mode | 0.39 W | 0.39 W | 0.39 W |
| AC 115V/60 Hz | Sleep mode | 1.1 W | 0.81 W | 2.6 W |
| | Power off mode | 0.30 W | 0.30 W | 0.30 W |