

**M-Series<sup>®</sup> M5000**  
**Electromagnetic Flow Meter**







# CONTENTS

Safety Precautions and Instructions . . . . .	5
System Description . . . . .	5
Unpacking and Inspection . . . . .	6
Rigging, Lifting and Moving Large Units . . . . .	6
Meter Location, Orientation and Applications . . . . .	8
Remote Amplifier Outdoor Location . . . . .	8
Pipelines and Fluid Flow . . . . .	8
Meter Orientation . . . . .	9
Vertical Placement . . . . .	9
Horizontal Placement . . . . .	9
Straight Pipe Requirements . . . . .	9
Pipe Reducer Requirements . . . . .	10
Chemical Injection Applications . . . . .	10
Partially-Filled Pipe Situations . . . . .	11
Meter Gaskets and Grounding . . . . .	12
Meter/Pipeline Connection Gaskets . . . . .	12
Meter Grounding . . . . .	12
Conductive Pipe Grounding . . . . .	12
Non-Conductive Pipe Grounding . . . . .	12
Pipelines with Cathodic Protection . . . . .	13
Amplifier Mounting Configuration Options . . . . .	13
Meter Mount Configuration . . . . .	13
Remote Mount Configuration . . . . .	13
Submersible Option . . . . .	13
Wiring . . . . .	14
Wiring Safety . . . . .	14
Opening the M5000 Cover . . . . .	14
Battery . . . . .	14
Battery Life . . . . .	14
Battery Replacement . . . . .	14
Remote Mount Installation . . . . .	15
Mount Bracket to Amplifier . . . . .	15
Wiring Configuration . . . . .	15
Wiring for Remote Configuration . . . . .	16
Configuring Input/Output (I/O) . . . . .	17
Circuit Board Diagram . . . . .	17
Digital Output Wiring Diagrams . . . . .	18
Digital Output Selections . . . . .	18
Programming the M5000 . . . . .	19
Function Buttons . . . . .	19
Display . . . . .	19

Icons . . . . .	19
Battery Level Indicators . . . . .	19
M5000 Main Menu Programming Options . . . . .	20
Navigating the Initial Main Screens . . . . .	20
Using the M5000 Main Menu . . . . .	21
Programming Options . . . . .	21
Security . . . . .	23
Setting a PIN. . . . .	23
Logging In . . . . .	23
Logging Out. . . . .	23
Meter Setup Menu. . . . .	24
Measure Menu . . . . .	25
Inputs/Outputs Menu. . . . .	27
Communication Menu . . . . .	29
Battery Menu . . . . .	30
Miscellaneous Menu . . . . .	31
Information Menu . . . . .	31
PIN Menu. . . . .	32
Faults Menu . . . . .	32
Maintenance . . . . .	33
Cleaning the Flow Tube and Electrode . . . . .	33
Troubleshooting . . . . .	34
Errors & Warnings . . . . .	35
Connecting an ORION RTR Endpoint to the M5000 Meter. . . . .	36
Wiring. . . . .	36
Programming . . . . .	36
Connecting an ORION Encoder Endpoint to the M5000 Meter . . . . .	37
Wiring. . . . .	37
Adding Resistor with ORION Cellular LTE . . . . .	37
Programming . . . . .	37
Specifications . . . . .	38

## SAFETY PRECAUTIONS AND INSTRUCTIONS

Some procedures in this manual require special safety considerations. In such cases, the text is emphasized with the following symbols:

Symbol	Explanation
 <b>WARNING</b>	Warning indicates the potential for severe personal injury, death or substantial property damage. Comply with the instructions and proceed with care.
 <b>CAUTION</b>	Caution indicates the potential for minor personal injury or property damage. Comply with the instructions and proceed with care.

## SYSTEM DESCRIPTION

The Badger Meter M-Series® model M5000 electromagnetic flow meter is intended for fluid metering in most industries including potable water, reclaimed water, food and beverage, pharmaceutical and chemical.

The basic components of an electromagnetic flow meter are:

- The **detector**, which includes the flow tube, isolating liner and measuring electrodes.
- The **amplifier**, which is the electronic device responsible for the signal processing, flow calculation, display and output signals.

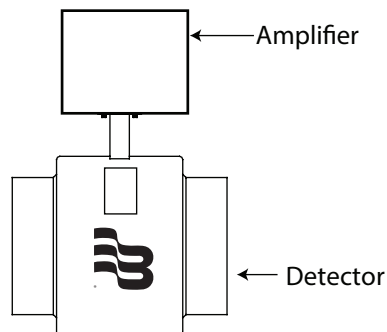

Figure 1: Amplifier and Detector

The construction materials of the wetted parts (liner and electrodes) should be appropriate for the specifications on the intended type of service. We recommend that you review all of the compatibilities consistent with the specifications. Each meter is factory tested and calibrated. A calibration certificate is included with each meter.

## UNPACKING AND INSPECTION

Follow these guidelines when unpacking the M-Series equipment.

- If a shipping container shows any sign of damage, have the shipper present when you unpack the meter.
- Follow all unpacking, lifting and moving instructions associated with the shipping container.
- Open the container and remove all packing materials. Store the shipping container and packing materials in the event the unit needs to be shipped for service.
- Verify that the shipment matches the packing list and your order form.
- Inspect the meter for any signs of shipping damage, scratches, or loose or broken parts.

**NOTE:** If the unit was damaged in transit, it is your responsibility to request an inspection report from the carrier within 48 hours. You must then file a claim with the carrier and contact Badger Meter for appropriate repairs or replacement.

- All detectors with polytetrafluoroethylene (PTFE) liners are shipped with a liner protector on each end to maintain proper form of the PTFE material during shipping and storage.

**NOTE:** Do not remove the liner protectors until you are ready to install.

- Storage: If the meter is to be stored, place it in its original container in a dry, sheltered location. Storage temperature ranges are:  $-40 \dots 160^{\circ}\text{F}$  ( $-40 \dots 70^{\circ}\text{C}$ ).

### Rigging, Lifting and Moving Large Units

#### **CAUTION**

**WHEN RIGGING, LIFTING OR MOVING LARGE UNITS, FOLLOW THESE GUIDELINES:**

- DO NOT lift or move a meter by its amplifier, junction box or cables.
- Use a crane rigged with soft straps to lift and move meters with flow tubes that are between two inches and eight inches (50 mm and 200 mm). Place the straps around the detector body, between the flanges, on each side of the detector.
- Use the lifting lugs when lifting meter flow tubes that are 10 inches (250 mm) in diameter or larger.

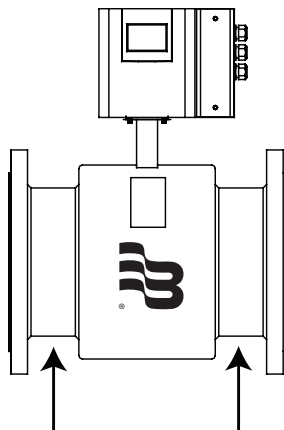

Place straps between flanges.

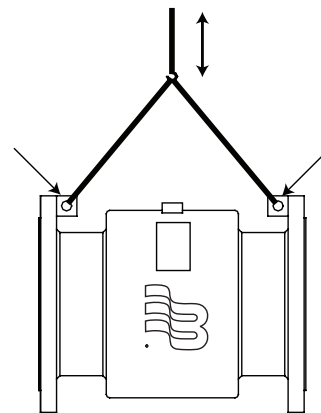

Use lifting lugs with 10-inch or larger meters.

Figure 2: Rigging Large Units

- Use the sling-rigged method to lift large detectors into a vertical position while they are still crated. Use this method to position large detectors vertically into pipelines.

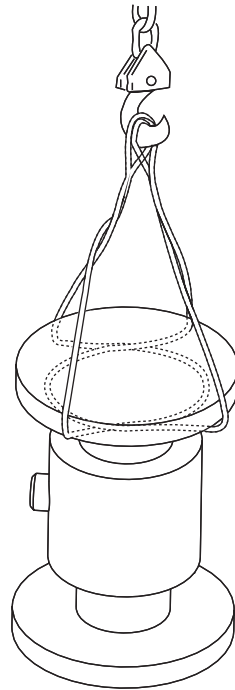
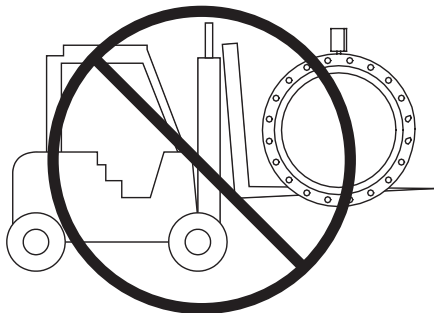
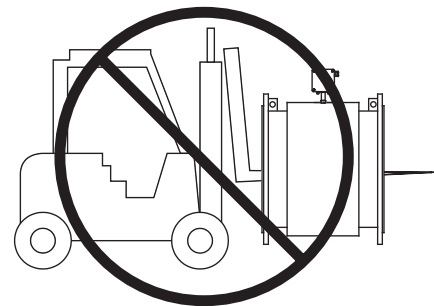

Figure 3: Sling-Rigged Lifting Methods

- Do not lift a detector with a forklift by positioning the detector body on the forks, with the flanges extending beyond the lift. This could dent the housing or damage the internal coil assemblies.
- Never place forklift forks, rigging chains, straps, slings, hooks or other lifting devices inside or through the detector's flow tube to hoist the unit. This could damage the isolating liner.



Do not lift detector with forklift.



Do not lift or rig lifting devices through detector.

Figure 4: Lifting and Rigging Cautions

## METER LOCATION, ORIENTATION AND APPLICATIONS

The M5000 provides two amplifier mounting options: an integral or meter mount option and a junction box/remote option.

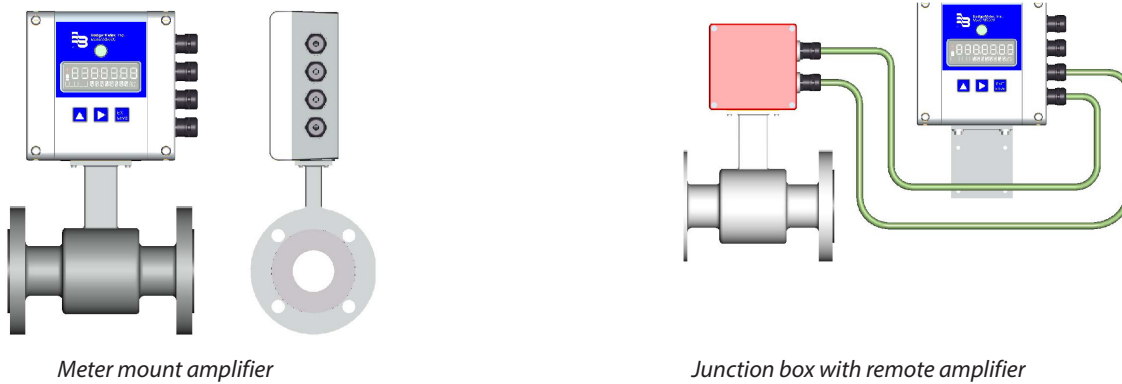

Figure 5: Amplifier Mounting Options

### Remote Amplifier Outdoor Location

The amplifier can be installed and operated outdoors. However, it must be protected from the elements, as follows:

- The ambient environment/temperature rating for the unit is  $-4 \dots 140^{\circ} \text{F}$  ( $-20 \dots 60^{\circ} \text{C}$ ).
- If an indoor location is within 100 feet (30 meters) of the detector, consider increasing the cable length (up to 100 ft) and mounting the amplifier indoors.
- At minimum, fabricate a roof or shield over and/or around the amplifier to protect the LCD display screen from direct sunlight.

### Pipelines and Fluid Flow

Take the following precautions during installation:

- Do not install the meter on pipes with extreme pipe vibrations. If pipes are vibrating, secure the piping with appropriate pipe supports in front of and behind the meter. If vibrations cannot be restrained, mount the amplifier in a remote location.
- Do not install the detector close to pipeline valves, fittings or impediments that can cause flow disturbances.
- For detectors with PTFE liners, do not install the detector on suction sides of pumps.
- Do not install the detector on outlet sides of piston or diaphragm pumps. Pulsating flow can affect meter performance.
- Avoid installing the detector near equipment that produces electrical interference such as electric motors, transformers, variable frequency, and power cables.
- Verify that both ends of the signal cables are securely fastened.
- Place power cables and signal cables in separate conduits. Do not install the signal cable close to other sources of electricity, such as power cables or electric machines.
- Place the meter where there is enough access for installation and maintenance tasks.



## Meter Orientation

Mag meters can operate accurately in any pipeline orientation and can measure volumetric flow in forward and reverse directions, as long as the pipe is completely full.

**NOTE:** A "Forward Flow" direction arrow is printed on the detector label.

## Vertical Placement

Mag meters perform best when placed vertically, with liquid flowing upward and meter electrodes in a closed, full pipe.

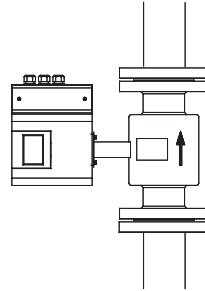

Figure 6: Vertical Placement

Vertical placement allows the pipe to remain completely full, even in low flow, low pressure applications, and it prevents solids build-up, sediment deposit and accumulation on the liner and electrodes.

**NOTE:** Carefully observe the "Forward Flow" label on the meter body and install the meter accordingly. When installed vertically, rotate amplifier so that cable glands are facing down.

## Horizontal Placement

M5000 meters are equipped with an *Empty Pipe Detection* feature. If an empty pipe electrode mounted in the pipe is not covered by fluid for five seconds, the meter will display an Empty Pipe Detection condition. The meter will send out an error message and stop measuring flow. When the electrode is again covered with fluid, the error message disappears and the meter will begin measuring.

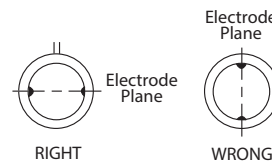

Figure 7: Horizontal Placement

When installing the meter on a horizontal pipe, mount the detector to the pipe with the flow-measuring electrode axis in a horizontal plane (three and nine o'clock). This placement helps prevent solids build-up, sediment deposit and accumulation on the electrodes.

## Straight Pipe Requirements

Sufficient straight-pipe runs are required at the detector inlet and outlet for optimum meter accuracy and performance. An equivalent of 3...7 diameters of straight pipe is required on the inlet (upstream) side to provide a stable flow profile. Two diameters are required on the outlet (downstream) side.

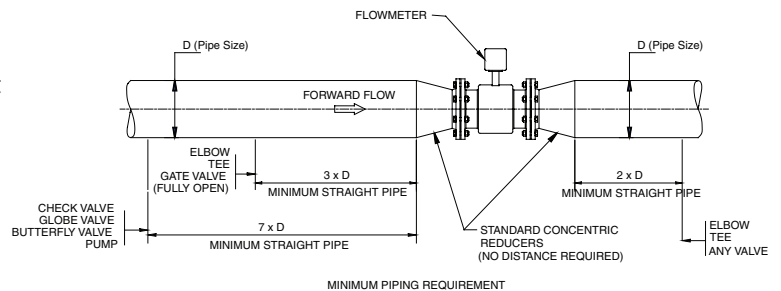

Figure 8: Straight Pipe Requirements

## Pipe Reducer Requirements

With pipe reducers, a smaller meter can be mounted in larger pipelines. This arrangement may increase low-flow accuracy. There are no special requirements for standard, concentric, pipe reducers.

Custom fabricated pipe reducers must have an approximate slope angle of 15 degrees to minimize flow disturbances and excessive loss of head. If this is not possible, install the custom pipe reducers as if they were fittings and install the required amount of straight pipe

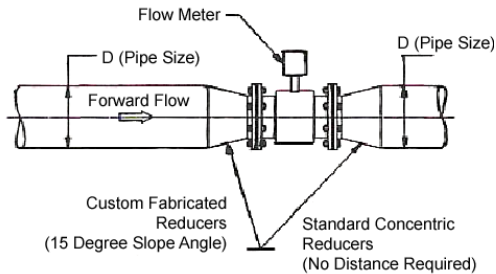

Figure 9: Pipe Reducer Requirements

## Chemical Injection Applications

For water line applications with a chemical injection point, install the meter upstream of the injection point. This eliminates any meter performance issues.

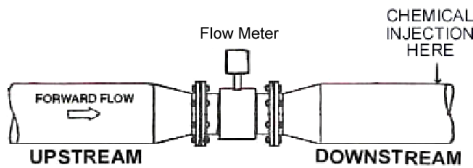

Figure 10: Chemical Injection Point Upstream of Meter

If a meter must be installed downstream of a chemical injection connection, the distance between the meter and the injection point should be between 50 and 100 feet (15 and 30 meters). The distance must be long enough to allow the water or chemical solution to reach the meter in a complete, homogeneous mixture.

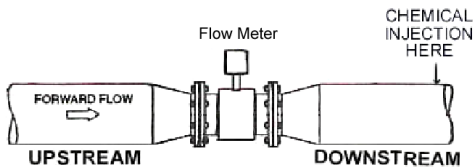

Figure 11: Chemical Injection Point Upstream of Meter

If the injection point is too close, the meter senses the two different conductivities for each liquid. This will likely result in inaccurate measurements. The injection method—spaced bursts, continuous stream of drips or liquid or gas—can also affect downstream readings by the meter.

## Partially-Filled Pipe Situations

In some locations, the process pipe may be momentarily only partially filled. Examples include: lack of back pressure, insufficient line pressure and gravity flow applications.

To eliminate these situations:

- Do not install the meter at the highest point of the pipeline.
- Do not install the meter in a vertical, downward flow section of pipe.
- Always position the ON/OFF valves on the downstream side of the meter.
- Turn ON *Empty Pipe* for applications or installations where the pipe will be empty.

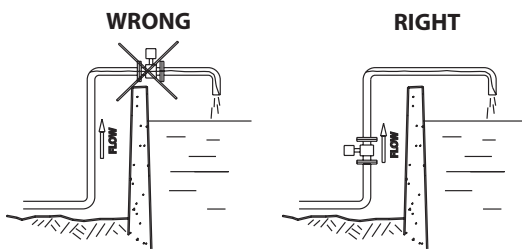
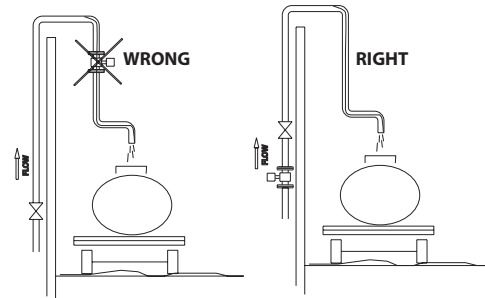

Figure 12: Incorrect Meter Placement



Do not install in a vertical, downward position.

Position "On/Off" valves on downstream side.

Figure 13: Position Valves on Downstream Side

To minimize the possibility of partially-full pipe flows in horizontal, gravity or low pressure applications, create a pipe arrangement that ensures the detector remains full of liquid at all times.

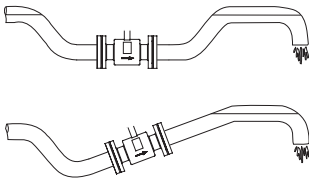

Figure 14: Pipe Positioned to Keep Water in Detector

## METER GASKETS AND GROUNDING

Gasket and grounding requirements must be considered when determining the meter location, orientation and application.

### Meter/Pipeline Connection Gaskets

You must install gaskets (not provided) between the detector's isolating liner and the pipeline flange to ensure a proper and secure hydraulic seal. Use gaskets that are compatible with the fluid. Center each gasket on the flange to avoid flow restrictions or turbulence in the line.

During installation, do not use graphite or any electrically conductive sealing compound to hold the gaskets. This could compromise the accuracy of the measuring signal.

If you are using a grounding ring (as Badger Meter recommends) in the detector/pipeline connection, place the ring between two gaskets. (See "Non-Conductive Pipe Grounding" on page 12.)

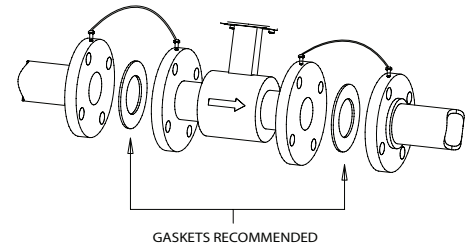

Figure 15: Meter/Pipeline Connection Gaskets

### Meter Grounding

Process pipeline material can be either electrically conductive (metal) or not electrically conductive (made of or lined with PVC, fiberglass or concrete).

#### IMPORTANT

*It is essential that the mag meter amplifier's input ground (zero voltage reference) be electrically connected to the liquid media and to a good, solid earth ground reference.*

### Conductive Pipe Grounding

To achieve an adequate ground, the meter body **MUST** be electrically connected to the liquid media. The mag meter flanges are provided with grounding bolts for this purpose.

If the pipe material is electrically conductive, simply install grounding straps between these grounding bolts and the mating flanges.

To ensure a good electrical connection at the mating flanges, we recommend that you drill and tap the flanges and install a grounding screw (not provided).

These grounding straps must be copper wire, at least 12 AWG size. They must be connected on both sides (inlet and outlet) of the detector and to a local, earth ground.

### Non-Conductive Pipe Grounding

#### IMPORTANT

*If the process pipe is not electrically conductive (PVC, fiberglass, cement-lined pipes or any other non-conductive material) and the meter was not originally ordered with an optional grounding electrode, you must install a pair of grounding rings between the mating flanges at both ends of the meter. See the following illustration.*

In this case, the grounding straps should be connected to both of the grounding rings and to a good, solid earth ground. Grounding rings are available in stainless steel. If your fluid is too aggressive for stainless steel, order a meter with the optional grounding electrode in a material compatible with the fluid.

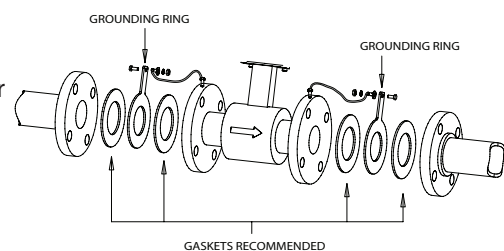

Figure 16: Non-Conductive Pipe Grounding

## Pipelines with Cathodic Protection

For pipelines with cathodic protection, install the meter potential-free. No electric connection from the meter to the pipeline system may exist and power supply is to be provided via isolating transformer.

### ⚠ CAUTION

**USE GROUNDING ELECTRODES. INSTALL GROUNDING RINGS ISOLATED FROM THE PIPELINE.**

**OBSERVE NATIONAL RULES REGARDING POTENTIAL-FREE INSTALLATIONS.**

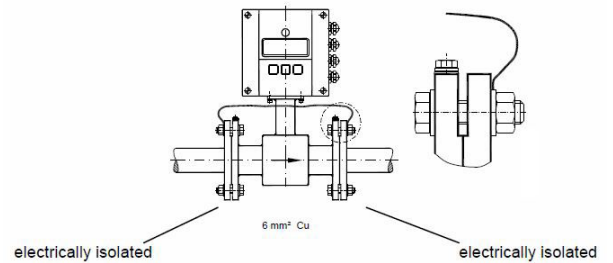

Figure 17: Potential-free installation

## AMPLIFIER MOUNTING CONFIGURATION OPTIONS

### Meter Mount Configuration

The meter mount configuration has the amplifier mounted directly on the detector. This compact, self-contained configuration minimizes installation wiring.

### Remote Mount Configuration

The remote mount configuration places the amplifier at a location away from the fluid flow and detector. This is necessary in situations where process fluid temperature or the environment exceeds amplifier ratings.

The detector and amplifier are connected by wires, run through conduit, between junction boxes on the detector and the amplifier. The distance between the detector junction box and amplifier junction box can be up to 100 feet (30 meters). A remote mounting bracket is supplied.

### Submersible Option

If you are installing the meter in a vault, you should order the remote amplifier option. You must not install the amplifier inside a vault. We also recommend ordering the remote meter package with the submersible option (NEMA 6P). This will eliminate any potential problems resulting from humidity or temporary flooding in the vault.

**NOTE:** NEMA 6P enclosures are constructed for indoor or outdoor use to provide protection against access to hazardous parts; to provide a degree of protection against ingress of solid foreign objects and water (hose directed water and the entry of water during prolonged submersion at a limited depth); that provide an additional level of protection against corrosion and that will be undamaged by the external formation of ice on the enclosure.

## WIRING

### Wiring Safety

#### **⚠ WARNING**

**AT INSTALLATION, BE SURE TO COMPLY WITH THE FOLLOWING REQUIREMENTS:**

- Disconnect power to the unit before attempting any connection or service to the unit.
- Do not bundle or route signal lines with power lines.
- Use twisted pair shielded wire for all output wiring.
- Observe all applicable, local electrical codes.

### Opening the M5000 Cover

The M5000 amplifier's design lets you open the cover without completely removing it.

Follow these steps:

1. Completely remove the top two screws from the amplifier using a blade/slotted screwdriver.
2. Loosen both of the bottom screws so that the round head of each screw clears the top face of the cover.
3. Pull the cover down to the open position.



Figure 18: Remove Two Screws



Figure 19: Open the Cover

## BATTERY

Use a two D-cell battery pack (1/2...6 in.) or a double two D-cell battery pack (8...24 in.).

### Battery Life

Standard Pack	
Sampling	Expected Life
0.25	3 months
4	4 years
8	8 years
15	10 years

These calculations are for a standard battery pack, with two D-size batteries, with communication and outputs OFF, at a temperature of 77° F (25° C). See "Battery Level Indicators" on page 19.

### Battery Replacement

1. Go to *Main Menu > Misc > Battery > Change* and select the capacity of the battery pack which should be installed (see label on the battery pack 19 Ah, 38 Ah or 70 Ah). Press **E** to quit. The display freezes (no reaction by pressing any button).
2. Open the cover.
3. Remove all connectors (detector and outputs).
4. Remove all 4 screws of the main board, remove the circuit board and disconnect the old battery.
5. Remove the old battery and wait about 2 minutes before replacing it with a new one (LCD display should be off).
6. Plug the battery connector into the back of the main board and reinstall the circuit board.
7. Replace all the plugs.
8. Close the cover tight.

9. Check time and date (*Main Menu > Misc > Time* and *Main Menu > Misc > Date DMY*).
10. Check capacity of battery (*Main Menu > Misc > Battery AH*). The first value is the used capacity, which should be 0.0. The second value is the capacity of the battery pack. *Battery AH* is a read-only parameter.

**NOTE:** Totalizers and configuration remain unaffected during battery replacement.

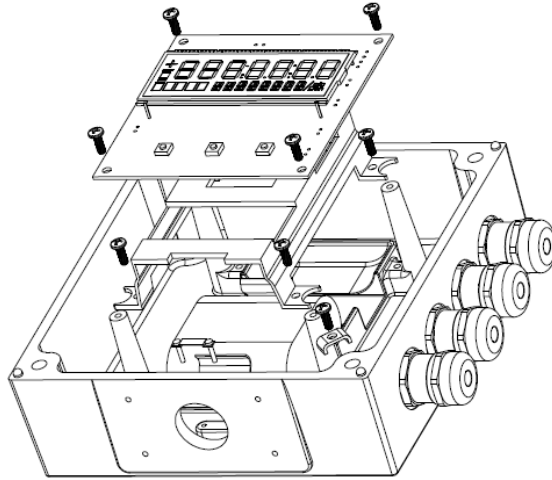

Figure 20: Amplifier Housing Components – Exploded View

## Remote Mount Installation

If you are installing the M5000 amplifier in a remote location, review the procedures in this section.

### Mount Bracket to Amplifier

1. Align bracket-mounting holes with amplifier mounting holes.
2. Attach bracket to amplifier with supplied screws. Torque the screws to 80 inch-pounds.

### Wiring Configuration

Wiring between the detector and the M5000 amplifier comes complete from the factory. If your installation requires the use of conduit, we recommend that you follow these steps when wiring the detector to the amplifier.

1. Carefully remove the wires connected to the terminal blocks that run to the M5000 amplifier or to the junction box. See the chart below for a reference of wire color to terminal connection.
2. Run cable through the conduit while retaining the wiring of the cable to the amplifier or the junction box, as supplied.
3. Complete conduit assembly on both ends and rewire the cable as it was previously wired.

### Wiring for Remote Configuration

Remote style M5000 amplifier models can be ordered with standard cables measuring 15, 30, 50 and 100 feet.

Junction Box		
Connection No.	Description	Wire Color
11	Coil	Red/Brown
12	Coil	Blue/White
13	Main Shield	Not Used
40	Empty Pipe	Pink
44*	Shield	Green
44*	Empty Pipe Shield	Shield Wire
45	Electrode	White
46	Electrode	Black

\*Connections with the No. 44 are lying on the same potential.

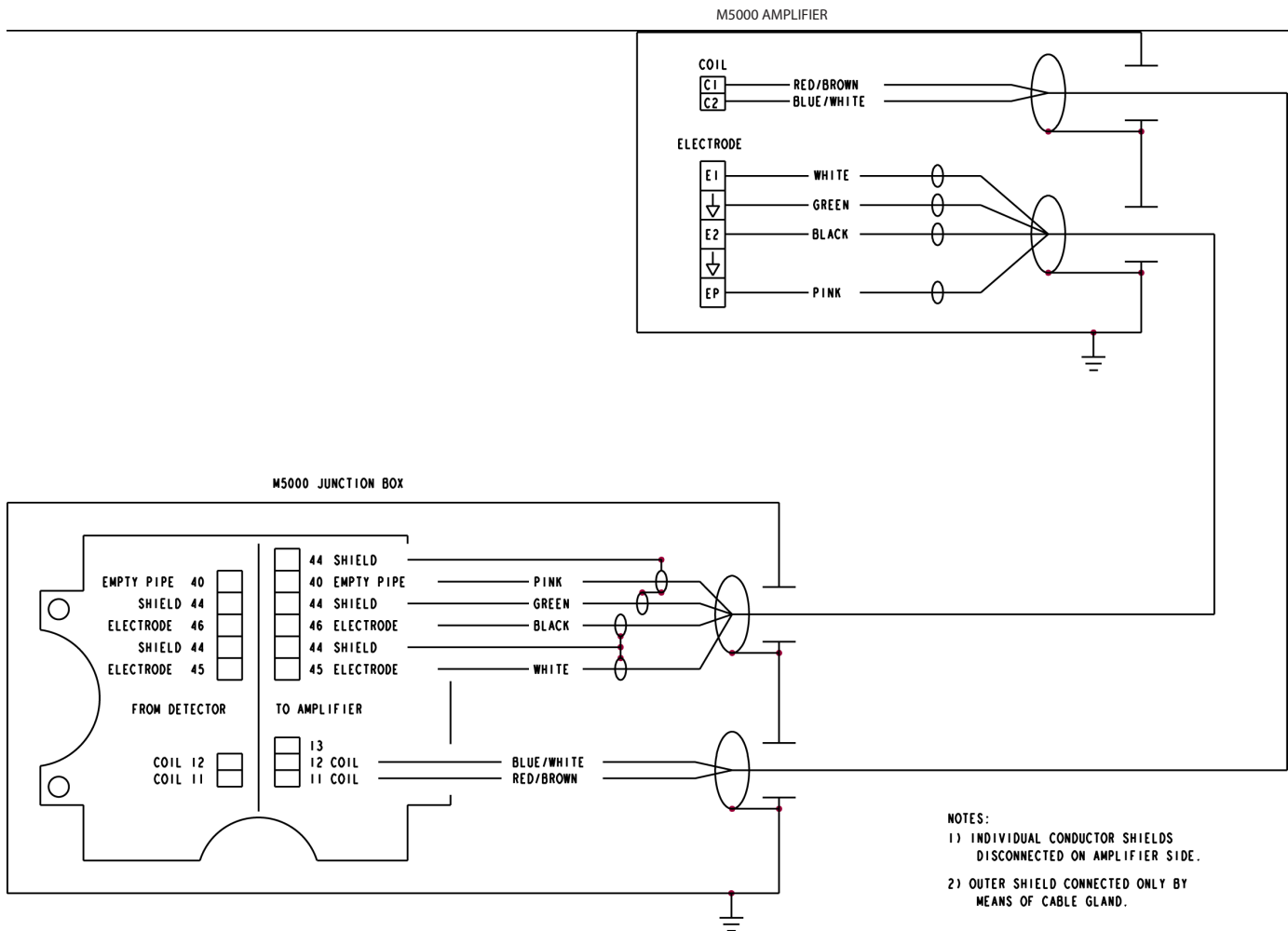

Figure 21: Wiring for Remote Configuration



## CONFIGURING INPUT/OUTPUT (I/O)

This section describes wiring the following M5000 outputs:

- Digital outputs
- Communication

When the sensor and the amplifier have been wired, wire any outputs to the M5000 amplifier.

Follow all of the safety precautions and local code to prevent electrical shock and damage to the electronic components.

### Circuit Board Diagram

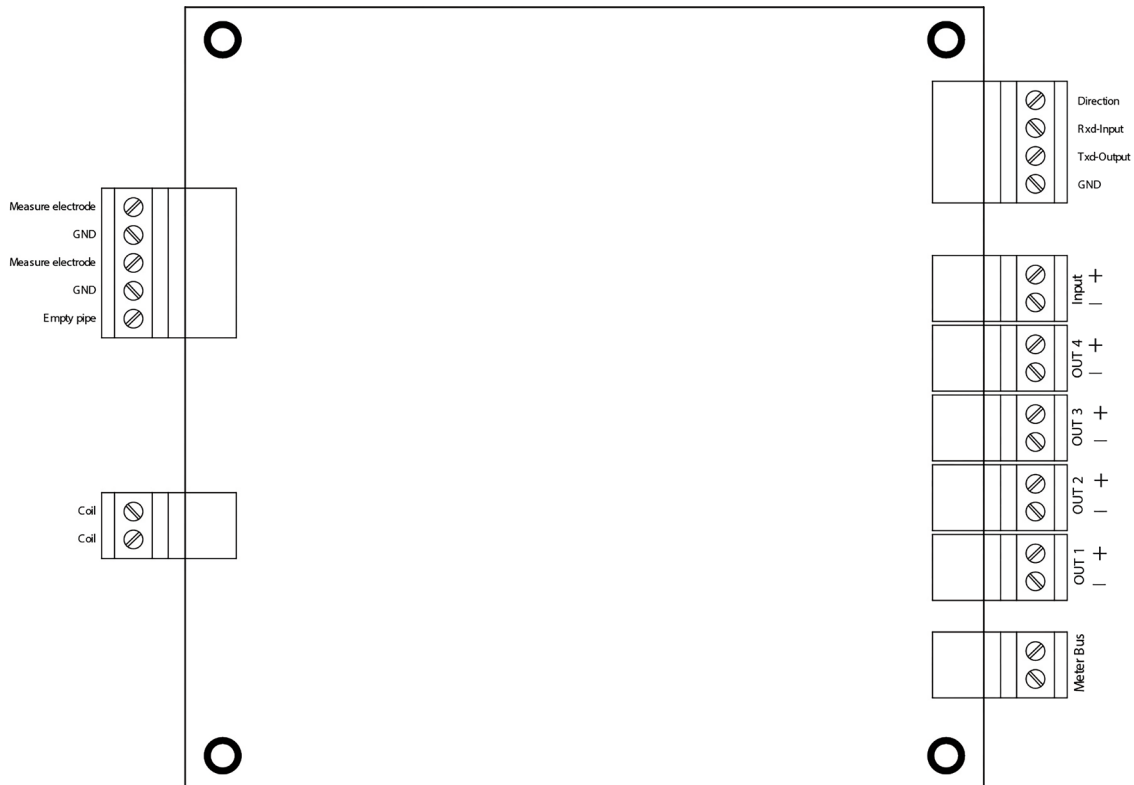

Figure 22: Configuring Input/Output

Input/Output	Description	Terminal
Output 1	Passive max. 30V DC, 20 mA Max. Frequency 100 Hz	OUT1 (+) and (-)
Output 2	Passive max. 30V DC, 20 mA Max. Frequency 100 Hz	OUT2 (+) and (-)
Output 3	Passive Max 30V DC, 20 mA	OUT3 (+) and (-)
Output 4	Passive Max 30V DC, 20 mA Can be used with digital input as an ADE interface.	OUT4 (+) and (-)
RS232	Modbus RTU	RxD, TxD, GND
IN	Digital input 3...35V DC	IN (+) and (-)
M-BUS	M-Bus interface	No polarity

**NOTE:** The M-Series M5000 meter also supports Modbus RTU RS485 communication. Modbus RTU communication options must be selected at time of order or can be ordered as a service part. See the "M-Series M5000 Modbus Communication Protocol Memory Map Application Data Sheet", available at [www.badgermeter.com](http://www.badgermeter.com).

**Digital Output Wiring Diagrams**

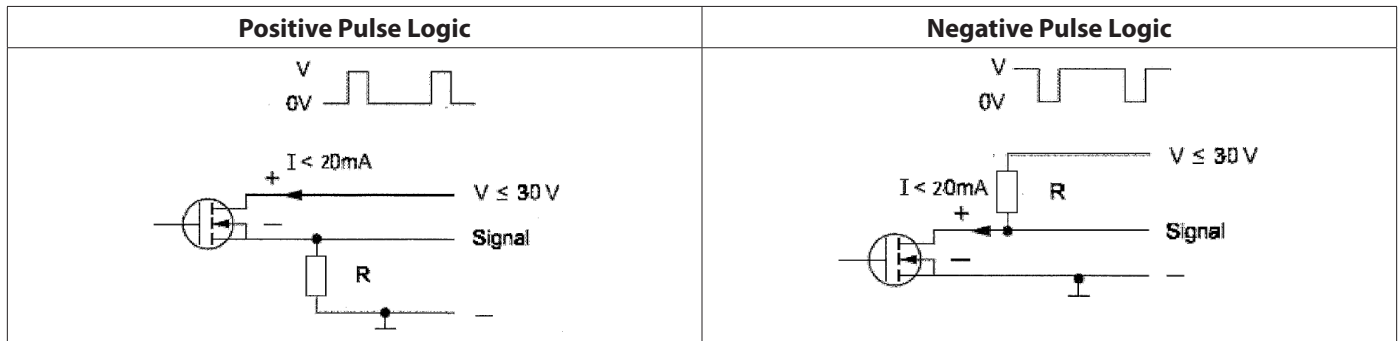

Figure 23: Digital Output Wiring Diagram

**Digital Output Selections**

Output 1	Output 2	Output 3	Output 4
Forward Pulse Output	Reverse Pulse Output	Flow direction (Forward vs. Reverse)	ADE
Flow Setpoint (0...100% of full scale, resolution 1%)		Flow Setpoint (0...100% of full scale, resolution 1%)	
Empty pipe alarm		Empty pipe alarm	
Error alarm		Error alarm	
Off			
Test			
Can be used with AMR when the pulse width is set to 50 milliseconds.		—	

Outputs are configurable for Pulses/Unit (PPU) and Pulse Width (PW). The PW is configurable from 5...500 milliseconds, with a frequency limit is 100 Hz. The PPU is displayed using an automatically selected resolution.

The high/low flow alarm functionality is configurable for maximum and minimum setpoints as a percentage of full-scale flow. Configurable values are settable from 0...100% in 1% increments.

## PROGRAMMING THE M5000

The M5000 amplifier is pre-programmed from the factory. No additional programming is necessary, however, for special features, the meter can be programmed for specific requirements.

### Function Buttons

All M5000 programming is accomplished using the three function buttons located on the front of the amplifier. Screen navigation and digit and parameter selection is performed by a combination of these three buttons.



The up-arrow button allows scrolling through nine menu screens. This button is also used to advance numerical digits to change values, such as frequency, period, and EP level as well as toggle on-off conditions and flow directions.

The right-arrow button allows digit selection from left to right and allows selecting either the top row of the display or the bottom row (the bottom row is active when flashing).





The EXIT SAVE button allows the saving of changed values and conditions, toggling between the upper and lower display lines and returning to a previous menu.

### Display

The top row displays seven digits for specific values on each screen and the bottom row displays meter and register condition icons and current screen descriptions.





### Icons

-  Battery status
-  Communication interface is activated (RS232, IrDA, M-Bus)
-  Meter is unlocked
-  Error message
-  Empty pipe detection

### Battery Level Indicators

The battery icon indicates three levels of capacity:

-  Greater than 3 volts (maximum = 3.6V)
-  Greater than 2 volts, less than 3 volts (recommended battery replacement)
-  Less than 2 volts (measuring has stopped)

## M5000 MAIN MENU PROGRAMMING OPTIONS

The following M5000 programming options are available from the *Main Menu*:

- *Meter Setup*
- *Measure*
- *In/Out*
- *Communication*
- *Battery*
- *Miscellaneous*
- *Information*
- *Pin*
- *Faults*

The applicable security level for each menu option is indicated as follows:



Administrative



Service



User



Parameters indicated by the battery icon, if changed, will affect battery performance.

## Navigating the Initial Main Screens

From the main display, press **EXIT/SAVE** to go back to the *Flow Rate* screen or press the **UP** arrow to scroll through the following:

Option	Description
Flow screen	Displays flow rate in selected units (for example, Gallons or Cubic Feet)
m/s	Displays flow in meter/second (factory programmed)
Percent	Percent of full scale flow
T1+	Total forward flow (in bidirectional mode)
T1-	Total reverse flow (in bidirectional mode)
T1N	Total net flow (in bidirectional mode)
T2+	Total forward flow (in bidirectional mode, non-resettable)
T2-	Total reverse flow (in bidirectional mode, non-resettable)
T2N	Total net flow (in bidirectional mode, non-resettable)
Login	Login when security is active
Main Menu	Access to Main Menu

## USING THE M5000 MAIN MENU

### PROGRAMMING OPTIONS

#### Display Menu Screen Hierarchy Structure (continued on next page)

- Main\_Menu →
  - Meter Setup → Calibration
    - Scale Factor
    - Frequency
    - Period
    - Empty Pipe
  - Measure → Flow Unit
    - Totalizer Unit
    - Full Scale Flow
    - Low Flow Cutoff
    - Flow Direction
    - Totalizer1 Reset
    - Median
    - Average
    - Filter Display
  - In/Out → Simulation
    - Digital Input
    - Outputs
  - Communication → Interface
    - Serial
    - MODBUS
    - M-Bus
    - ADE
  - Battery → PwrUpCnt
    - Voltage
    - Lifetime
    - OnTime
    - Ah
    - Capacity
    - Limit
    - Change

## Display Menu Screen Hierarchy Structure (continued)

- Main Menu** → **Miscellaneous** → Settling
  - Language
  - Date DMY
  - Time
  - EEPROM
  - Restart
  - HDD Free
  - Polar[V]
  - Datalogger
  - LCD Test
- Info** → Serial Number
  - Version
  - Compilation Date
  - OtpCrc
  - AppCrc
  - OimLMode
- PINs** → Control
  - User
  - Service
  - Admin
  - Random
  - Emergency
- Faults** → Preamp
  - Coil
  - Empty Pipe
  - Measure Time
  - Voltage Overflow

---

## SECURITY

The M5000 security feature allows the option to restrict access to the meter by way of a 6-digit Personal Identification Number (PIN). The system administrator can set up a single PIN for each of the three different levels of access:

- **Administration** – allows access to all M5000 menu configuration screens.
- **Service** – allows access to service-level and user-level menu configuration screens.
- **User** – allows access only to user-level menu configuration screens.

**NOTE:** For a lost PIN, Contact Badger Meter Technical Support at 800-456-5023 for a replacement PIN.

Not all levels of access need to be set. If no PINs are set up, any M5000 user will have access to all functions.

**NOTE:** The security settings will also apply to remote access. All remote writes via Modbus to the meter will be blocked unless the user is remotely logged in.

### Setting a PIN

1. From the *Main Menu*, press the **right-arrow** button.
2. From the *Meter Setup* menu, press the **up-arrow** button until the *Pin* menu is displayed.
3. Press the **right-arrow** button to display the *PINS Control* menu.
4. Press the **right-arrow** button to flash ON or OFF.
5. With either ON or OFF flashing, press the **up-arrow** button to display ON.
6. Press the **EXIT SAVE** button to save the ON setting.
7. With the *Control* menu flashing, press the **up-arrow** button to display the desired security level (user, service, or admin).
8. With the desired security level flashing, press the **right-arrow** button to display the upper row of six zeros (digits).
9. Press the **up-arrow** button to change the first digit, followed by pressing the **right-arrow** button to select the next digit.
10. Press the **EXIT SAVE** button to save the PIN number for that security level.

The saved PIN number will be the same PIN number used to log in to the amplifier.

**NOTE:** Be sure to log off when you have completed work with the M5000. Otherwise, a five-minute time delay occurs between the most recent activity and the time when the M5000 automatically logs off.

### Logging In

To change any parameter in the mag meter, the PIN entered must provide the proper security privilege required by the parameter.

To enter a PIN, go to the *Login* menu and enter the PIN for the required security level.









Once you are properly logged in, the unlocked icon appears on the meter display.

**NOTE:** A **PIN Error** message displays if the incorrect PIN is entered.

### Logging Out



To log out, follow steps 1 through 8 under Setting a PIN. At step 9, enter an invalid PIN, then press **EXIT SAVE**.



## Meter Setup Menu

<b>Meter Setup</b>		
<b>Calibration</b>	<b>Diameter</b> 	This parameter is set at the factory. In the event the amplifier is replaced, verify that the pipe diameter matches the installed pipe size.
	<b>Detector Factor</b> 	This parameter is set at the factory. This factor compensates for accuracy error as a result of the installed detector. In the event the amplifier is replaced, this parameter must be reprogrammed with the original detector factor.
	<b>Detector Zero</b> 	This parameter is set at the factory. This parameter compensates for accuracy error as a result of the installed detector. In the event the amplifier is replaced, this parameter must be reprogrammed with the original detector zero.
	<b>Amplifier Factor</b>	This parameter is set at the factory and is Read Only. This factor compensates for accuracy error as a result of the installed amplifier.
	<b>Coil Current</b>	This parameter is set at the factory and is Read Only. This factor compensates for accuracy error as a result of the installed amplifier.
<b>Scale Factor</b> 	Changing the scale factor lets you adjust the meter's accuracy without disturbing parameters set by the factory. You can tune the meter to meet changing application requirements.	
<b>Power Line Frequency</b>	<b>60 Hz</b> 	This parameter provides measuring immunity to industrial noise from a power supply feed. It is factory set to 60 Hz, which is the value used in the US.
	<b>50 Hz</b>	Optional setting. 50 Hz is the value used outside the US.
<b>Period</b> 	This parameter configures the frequency (1/4, 1...99 seconds) of sampled measurements. In other words, if set to 15, then every 15 seconds it will sample for 208 micro seconds. <b>NOTE:</b> Parameters indicated by the battery icon, if changed will affect battery performance. Standard sampling period is 15 seconds.	
<b>Empty Pipe Detection</b>	<b>Empty Pipe ON/OFF</b> 	When set to ON, an Empty Pipe condition indicates to the outputs that the meter is not completely filled. When set to OFF, empty pipe conditions are not detected.
	<b>Threshold</b> 	This parameter is set at the factory and adjusted to the conductivity of normal water.
	<b>Measure</b>	Measures the real empty pipe value. This parameter is Read Only.











## Measure Menu

<b>Measure</b>																																									
<p><b>Flow Unit</b></p> 	<p>This parameter establishes the unit of measure for the flow rate and full scale flow. Changing this parameter readjusts the full scale flow parameter. For example, changing from GPM to GPS would change the full scale flow from 60 gal/min to 1 gal/s.</p> <table border="1" style="width: 100%; border-collapse: collapse;"> <thead> <tr> <th style="text-align: center;"><i>Display</i></th> <th style="text-align: center;"><i>Flow Unit</i></th> <th style="text-align: center;"><i>Display</i></th> <th style="text-align: center;"><i>Flow Unit</i></th> </tr> </thead> <tbody> <tr> <td>L/s</td> <td>Liters/Second</td> <td>gal/s</td> <td>Gallons/Sec.</td> </tr> <tr> <td>L/min</td> <td>Liters/Minute</td> <td>gal/min</td> <td>Gallons/Min.</td> </tr> <tr> <td>L/h</td> <td>Liters/Hour</td> <td>gal/h</td> <td>Gallons/Hour</td> </tr> <tr> <td>m<sup>3</sup>/s</td> <td>Cubic Meters/Sec.</td> <td>MG/d</td> <td>MillionGallons/Day</td> </tr> <tr> <td>m<sup>3</sup>/min</td> <td>Cubic Meters/Min.</td> <td>IG/s</td> <td>ImperialGallons/Sec.</td> </tr> <tr> <td>m<sup>3</sup>/h</td> <td>Cubic Meters/Hour</td> <td>IG/min</td> <td>ImperialGallons/Min.</td> </tr> <tr> <td>ft<sup>3</sup>/s</td> <td>Cubic Feet/Sec.</td> <td>IG/h</td> <td>ImperialGallons/Hour</td> </tr> <tr> <td>ft<sup>3</sup>/m</td> <td>Cubic Feet/Min.</td> <td>oz/min</td> <td>Ounce/Min</td> </tr> <tr> <td>ft<sup>3</sup>/h</td> <td>Cubic Feet/Hour.</td> <td>bbl/min</td> <td>Barrel/Min</td> </tr> </tbody> </table>	<i>Display</i>	<i>Flow Unit</i>	<i>Display</i>	<i>Flow Unit</i>	L/s	Liters/Second	gal/s	Gallons/Sec.	L/min	Liters/Minute	gal/min	Gallons/Min.	L/h	Liters/Hour	gal/h	Gallons/Hour	m <sup>3</sup> /s	Cubic Meters/Sec.	MG/d	MillionGallons/Day	m <sup>3</sup> /min	Cubic Meters/Min.	IG/s	ImperialGallons/Sec.	m <sup>3</sup> /h	Cubic Meters/Hour	IG/min	ImperialGallons/Min.	ft <sup>3</sup> /s	Cubic Feet/Sec.	IG/h	ImperialGallons/Hour	ft <sup>3</sup> /m	Cubic Feet/Min.	oz/min	Ounce/Min	ft <sup>3</sup> /h	Cubic Feet/Hour.	bbl/min	Barrel/Min
<i>Display</i>	<i>Flow Unit</i>	<i>Display</i>	<i>Flow Unit</i>																																						
L/s	Liters/Second	gal/s	Gallons/Sec.																																						
L/min	Liters/Minute	gal/min	Gallons/Min.																																						
L/h	Liters/Hour	gal/h	Gallons/Hour																																						
m <sup>3</sup> /s	Cubic Meters/Sec.	MG/d	MillionGallons/Day																																						
m <sup>3</sup> /min	Cubic Meters/Min.	IG/s	ImperialGallons/Sec.																																						
m <sup>3</sup> /h	Cubic Meters/Hour	IG/min	ImperialGallons/Min.																																						
ft <sup>3</sup> /s	Cubic Feet/Sec.	IG/h	ImperialGallons/Hour																																						
ft <sup>3</sup> /m	Cubic Feet/Min.	oz/min	Ounce/Min																																						
ft <sup>3</sup> /h	Cubic Feet/Hour.	bbl/min	Barrel/Min																																						
<p><b>Totalizer Unit</b></p> 	<p>This parameter establishes the units of measure for the totalizers.</p> <table border="1" style="width: 100%; border-collapse: collapse;"> <thead> <tr> <th style="text-align: center;"><i>Display</i></th> <th style="text-align: center;"><i>Totalizer Unit</i></th> </tr> </thead> <tbody> <tr> <td>L</td> <td>Liters</td> </tr> <tr> <td>hL</td> <td>Hectoliter</td> </tr> <tr> <td>m<sup>3</sup></td> <td>Cubic Meters</td> </tr> <tr> <td>ft<sup>3</sup></td> <td>Cubic Feet</td> </tr> <tr> <td>gal</td> <td>U.S. Gallons</td> </tr> <tr> <td>MG</td> <td>Million Gallons</td> </tr> <tr> <td>IG</td> <td>Imperial Gallons</td> </tr> <tr> <td>bbl</td> <td>Barrel (42 gallons)</td> </tr> <tr> <td>oz</td> <td>Fluid Ounces</td> </tr> <tr> <td>ac/ft</td> <td>Acre per foot</td> </tr> </tbody> </table>	<i>Display</i>	<i>Totalizer Unit</i>	L	Liters	hL	Hectoliter	m <sup>3</sup>	Cubic Meters	ft <sup>3</sup>	Cubic Feet	gal	U.S. Gallons	MG	Million Gallons	IG	Imperial Gallons	bbl	Barrel (42 gallons)	oz	Fluid Ounces	ac/ft	Acre per foot																		
<i>Display</i>	<i>Totalizer Unit</i>																																								
L	Liters																																								
hL	Hectoliter																																								
m <sup>3</sup>	Cubic Meters																																								
ft <sup>3</sup>	Cubic Feet																																								
gal	U.S. Gallons																																								
MG	Million Gallons																																								
IG	Imperial Gallons																																								
bbl	Barrel (42 gallons)																																								
oz	Fluid Ounces																																								
ac/ft	Acre per foot																																								
<p><b>Full Scale Flow</b></p> 	<p>This parameter sets the maximum flow that the system is expected to measure. This parameter has influence on other system parameters, which include:</p> <ul style="list-style-type: none"> <li>• Low Flow Cutoff – Changes to full scale flow affect the measuring cut-off threshold of the meter</li> <li>• Alarm Outputs – Changes to full scale flow adjusts the thresholds for generating setpoint alarms</li> <li>• Pulse Outputs – Changes to full scale flow adjusts the pulse frequency and duty cycle</li> </ul> <p>Change the full scale flow based on the meter size and the application's requirements. Verify that the full scale flow falls within the meter's suggested flow range limits.</p> <p>Flow Range: 0.1...32.8 ft/s (0.03...10 m/s)</p> <p>The full scale flow is valid for both flow directions.</p> <p><b>NOTE:</b> If the flow rate exceeds the full scale setting by more than 25%, a FLOW_OVERLOAD_WARNING message indicates that the configured full scale range has been exceeded. However, the meter will continue to measure. This will affect the latency of the pulse outputs and possibly cause overflow.</p>																																								





<b>Measure</b>	
<b>Low Flow Cutoff</b> 	Low flow cutoff defines the threshold at which flow measurement will be forced to zero. The cutoff value can be set from 0% to 10% of the full scale flow. Increasing this threshold will help prevent false readings during “no flow” conditions possibly caused by pipe vibration or inherent system noise.
<b>Flow Direction</b> 	This parameter allows setting the meter to measure forward flow only (unidirectional) or both forward and reverse flow (bidirectional). <b>Unidirectional</b> Flow is totalized in only one direction. The flow direction is indicated by the arrow printed on the detector label. Unidirectional measurements on the main display screen include: T1: Registers forward flow, resettable by menu or Modbus RTU. T2: Registers forward flow, non-resettable. <b>Bidirectional</b> Flow is totalized in both directions. Bidirectional measurements on the main display screen include: T1+: Registers forward flow, resettable by menu or Modbus RTU T1-: Registers reverse flow, resettable by menu or Modbus RTU T1N: Registers total flow, T+ - T-, resettable by menu or Modbus RTU T2+: Registers forward flow, non-resettable T2-: Registers reverse flow, non-resettable T2N: Registers total flow, T+ - T-, non-resettable
<b>T1 Reset</b> 	This parameter allows the reset of totalizer T1.
<b>Median</b>	This parameter can be set to ON or OFF. When set to ON, the median display filters out the flow rate fluctuations displayed on the LCD.
<b>Average</b>	Known as a measurement averaging filter. The user can select how many flow rate measurements shall be averaged together to calculate the current flow rate value. It will dampen the rate of change of the flow rate.
<b>Filter Display</b>	This parameter can be set from 0...99 seconds. The display will update less frequently, depending on how high the filter display is set.

## Inputs/Outputs Menu



<b>Inputs/Outputs</b>	
<b>Flow Simulation</b> 	Flow Simulation provides output simulation based on a percentage of the full scale flow. Simulation will not accumulate the totalizers. The range of simulation includes –100...100% of the full scale flow. The Flow Simulation Parameter lets you set the range of simulation in increments of 50 (OFF, 0, 50, 100, -50, -100). The factory default is OFF.
<b>Digital Input</b> 	<ul style="list-style-type: none"> <li>Digital input lets you reset the T1 totalizer or interrupt flow measurement. Only the T1 can be reset.</li> <li>Input switching is provided by applying an external voltage of 3...35V DC.</li> <li>Use a “normally open” contact for operating.</li> </ul>
<b>Digital Outputs</b> <i>(continued on next page)</i>	<div style="display: flex; justify-content: space-between;"> <div style="width: 30%;"> <b>Pulse/Unit</b>   </div> <div style="width: 65%;">           This parameter lets you set how many pulses per unit of measure will be transmitted to remote applications. For example, assuming the unit of measure is gallons:           <ul style="list-style-type: none"> <li>Setting the Pulses/Unit to 1 (standard setting) will transmit 1 pulse every gallon</li> <li>Setting the Pulses/Unit to 0.01 will transmit 1 pulse every 100 gallons</li> </ul>           You must configure pulses/unit if the function of the selected output is to be forward or reverse .            This parameter must be considered with the Pulse Width and Full Scale Flow parameters. The maximum pulse frequency is 100 Hz. The frequency is correlated with the flow rate. Violation of output frequency limits will generate a PULSE_OVERLOAD_WARNING.         </div> </div>
	<div style="display: flex; justify-content: space-between;"> <div style="width: 30%;"> <b>Width</b>   </div> <div style="width: 65%;">           This parameter establishes the ON duration of the transmitted pulse. The configurable range is 0...500 ms. The factory default is 0 ms.           <ul style="list-style-type: none"> <li>Non-zero pulse width configuration – the OFF duration of the transmitted pulse is dependent on flow rate. The OFF duration is to be at least the configured ON duration. At full scale flow, the ON duration equals the Off duration. The maximum configurable output frequency is limited to 100 Hz.</li> <li>The duty cycle of the transmitted pulse is at 50% of the output frequencies greater than 1 Hz.</li> </ul>           This parameter must be considered with the Pulses/Unit and Full Scale Flow parameters. The maximum pulse frequency is 100 Hz. The frequency is correlated with the flow rate. Violation of output frequency limits will generate a PULSE_OVERLOAD_WARNING.         </div> </div>
	<div style="display: flex; justify-content: space-between;"> <div style="width: 30%;"> <b>Power Line Frequency</b>   </div> <div style="width: 65%;">           This parameter provides measuring immunity to industrial noise from a power supply feed.             This parameter should be set to your nominal line frequency, typically 60 Hz.         </div> </div>

<b>Inputs/Outputs</b>																																																				
<b>Digital Outputs</b> (continued)	<b>Set Min.</b> 	This parameter establishes, as a percentage of full scale flow, the threshold at which the output alarm will be activated. Flow rates below the threshold will activate the output alarm.																																																		
	<b>Set Max.</b> 	This parameter establishes, as a percentage of full scale flow, the threshold at which the output alarm will be activated. Flow rates above the threshold will activate the output alarm.																																																		
	[Out 1 Func] [Out 2 Func] [Out 3 Func] [Out 4 Func] 	This parameter provides configuration of the functional operation of the associated output. The following operations are supported: <table border="1" style="width: 100%; border-collapse: collapse; text-align: center;"> <thead> <tr> <th>Function</th> <th>Dig1</th> <th>Dig2</th> <th>Dig3</th> <th>Dig4</th> </tr> </thead> <tbody> <tr> <td>Off</td> <td>X</td> <td>X</td> <td>X</td> <td></td> </tr> <tr> <td>Test</td> <td>X</td> <td>X</td> <td>X</td> <td></td> </tr> <tr> <td>MinMax</td> <td>X</td> <td>X</td> <td>X</td> <td></td> </tr> <tr> <td>Empty</td> <td>X</td> <td>X</td> <td>X</td> <td></td> </tr> <tr> <td>ErAlarm</td> <td>X</td> <td>X</td> <td>X</td> <td></td> </tr> <tr> <td>Forward</td> <td>X</td> <td></td> <td></td> <td></td> </tr> <tr> <td>Reverse</td> <td></td> <td>X</td> <td></td> <td></td> </tr> <tr> <td>Direct</td> <td></td> <td></td> <td>X</td> <td></td> </tr> <tr> <td>ADE</td> <td></td> <td></td> <td></td> <td>X</td> </tr> </tbody> </table> <ul style="list-style-type: none"> <li>• Inactive [Off] means digital output is switched off. It is recommended to switch off the outputs in the menu "Output function" if not used. This increase the battery life time.</li> <li>• Test [Test] triggers the output.</li> <li>• Flow setpoint [MinMax] provides indication when flow rate exceeds thresholds defined by flow setpoints (set min, set max).</li> <li>• Empty pipe alarm [Empty] provides indication when pipe is empty.</li> <li>• Error alarm [ErAlarm] provides indication when meter has error condition.</li> <li>• Forward pulse [Forward] generates pulses during forward flow conditions.</li> <li>• Reverse pulse [Reverse] generates pulses during reverse flow conditions.</li> <li>• Flow direction [Direct] provides indication on current flow direction.</li> <li>• ADE [ADE] "Absolute Digital Encoder" for remote meter reading using ASCII communication protocol.</li> </ul>	Function	Dig1	Dig2	Dig3	Dig4	Off	X	X	X		Test	X	X	X		MinMax	X	X	X		Empty	X	X	X		ErAlarm	X	X	X		Forward	X				Reverse		X			Direct			X		ADE				X
	Function	Dig1	Dig2	Dig3	Dig4																																															
Off	X	X	X																																																	
Test	X	X	X																																																	
MinMax	X	X	X																																																	
Empty	X	X	X																																																	
ErAlarm	X	X	X																																																	
Forward	X																																																			
Reverse		X																																																		
Direct			X																																																	
ADE				X																																																
[Out 1 Type] [Out 2 Type] [Out 3 Type] [Out 4 Type] 	This parameter lets you set the output switch to normally open or normally closed. If normally open is selected, the output switch is open (no current) when the output is inactive, and closed (current flows) when the output is active. If normally closed is selected, the output switch is closed (current flows) when the output is inactive, and open (no current) when the output is active.																																																			







## Communication Menu

Communication: Port Settings		
<b>Interface</b> 	This parameter provides communication port configuration. <ul style="list-style-type: none"> <li>• IrDA (Modbus RTU)</li> <li>• Serial (Modbus RTU)</li> <li>• M-Bus</li> <li>• OFF (turns off the serial interfaces). Serial interfaces left ON will shorten the battery life.</li> </ul>	
<b>Serial</b>	<b>Baud Rate</b> 	This parameter sets the baud rate. The following baud rates are supported: <ul style="list-style-type: none"> <li>• 9600 (Default)</li> <li>• 1200</li> <li>• 2400</li> </ul>
	<b>Parity</b> 	This parameter sets the parity. The following parities are supported: <ul style="list-style-type: none"> <li>• Even (Default)</li> <li>• Odd</li> <li>• Mark</li> </ul>
<b>Modbus</b>	<b>Address</b> 	This parameter configures the Modbus address in the range from 1...247. See the " <i>M-Series M-5000 Modbus Communication Protocol Memory Map</i> " application data sheet (available at <a href="http://www.badgermeter.com">www.badgermeter.com</a> ) for Modbus register information.
<b>M-Bus</b>	<b>Address</b> 	MeterBus protocol mainly used in the European market. Please direct questions to Badger Meter Technical Support.
<b>ADE</b>	<b>Control</b>	ON/OFF
	<b>Protocol</b>	V1 standard messages V2 extended messages
	<b>Dial</b>	4...9
	<b>Resolution</b>	0.0001...10000

## Battery Menu

<b>PwrUpCnt</b> (Read Only)	(Power Up Counter) A diagnostic counter of how many times the meter has reset or been power cycled (for instance, battery removed and replaced).	
<b>Voltage</b> (Read Only)	Displays the current battery voltage.	
<b>Lifetime</b> (Read Only)	(Read Only) Displays the remaining battery life time in years depending on the currently selected parameters. <b>NOTE:</b> Battery life time is mainly influenced by the excitation frequency (period) and selected communication interfaces.	
<b>OnTime</b> (Read Only)	An engineering diagnostic that refers to the amount of time the meter has been powered in terms of hours	
<b>Ah</b> (Read Only)	The battery capacity used in terms of amp hours (ah).	
<b>Capacity</b> (Read Only)	Displays the current battery capacity (0-38V to 38/38V). <b>NOTE:</b> A new battery should be at or near 0/38 reading.	
<b>Limit</b> 	<b>Options: 5, 10, 15, 20, 25, 30, OFF</b>	Sets the battery capacity remaining threshold that will generate an output alarm if an output is configured to trigger when the battery capacity remaining is below the configured threshold.
<b>Change</b> 	<b>Options: 19, 38, 70, Ah</b>	A menu item that allows the user to change the battery through a controlled process. The user shall select the new battery pack capacity and then shall be required to replace the battery. Exit from this menu item once in entry mode is prohibited (i.e. the battery must be replaced). Additionally, this is the required process to save necessary measurement data to non-volatile memory while also resetting all battery configuration and diagnostic data (such as lifetime, capacity remaining, totalizers were saved).





## Miscellaneous Menu

<b>Misc</b>	
<b>Settling</b>	The time the magnetic circuit takes to settle. An engineering diagnostic.
<b>Language</b> 	This parameter allows changing the current language. English is the default setting. The following languages are supported: German (Deutsch), Czech (Cestina), Spanish (Espanol), French (Francais), Russian (России), Italian (Italiano).
<b>Day, Month, Year</b> 	A real-time calendar. The day, month, and year must be reprogrammed after the battery is replaced.
<b>Time</b> 	A real-time clock. The hour, minute, and second must be reprogrammed after the battery is replaced.
<b>EEPROM</b> 	Format the EEPROM to erase all log files. Totalizers and configuration remain unaffected during a format.
<b>Battery</b> 	Saves Totalizers to nonvolatile memory in preparation for battery replacement.
<b>Restart</b> 	Provides the ability to reset the meter electronics.
<b>HDD Free</b> 	Indicates the amount of free flash memory space.
<b>Polarity</b>	Measured electrode polarizing voltage (just for service purposes).
<b>Datalogger</b>	The logging period can be adjusted to the following values: 1 min / 15 min / 1 h / 6 h / 12 h / 24 h. See the <i>Datalogging User Manual</i> for more information.
<b>LCD Test</b>	After pressing E, all display segments appear for about 2 seconds.

## Information Menu

<b>Info</b>	
<b>Serial Number</b>	Serial number of the electronic board.
<b>Version</b>	Software version of the device.
<b>Compilation Date</b>	Date of the software version.
<b>OPT CRC</b>	Checksum of the software update.
<b>APP CRC</b>	Checksum of the application.
<b>OimLMode</b>	If the meter is used as a water meter according to OIML R49 or MID, the mode have to be ON. In this case, all parameters "read only".

## PIN Menu

<b>PIN</b>	
<b>Control</b> 	Two options are available: <ul style="list-style-type: none"> <li>• ON (requires PIN configuration)</li> <li>• OFF</li> </ul>
<b>User</b> 	Users logged in with this PIN have access to all user levels. Users at this level do not have access to Service or Admin functions.
<b>Service</b> 	Users logged in with this PIN have access to both service and user-level procedures. Users at this level do not have access to Admin functions.
<b>Admin</b> 	Users logged in with this PIN have access to all procedures. Users at this level have full access to the meter.
<b>Random</b>	This function generates a random number which is used when a PIN is lost. This number will be needed for Badger Meter Tech Support to provide a Master PIN.
<b>Emergency</b>	Enter the Master PIN received from Badger Meter Technical Support to unlock the meter in case the Admin PIN has been lost.

## Faults Menu

<b>Faults</b>	
<b>Preamp</b>	The Faults menu displays the errors and the number of time they have occurred each hour. For an explanation of the error that has occurred or how to fix it, see <i>"Errors &amp; Warnings"</i> on page 35.
<b>Coil</b>	
<b>Empty Pipe</b>	
<b>Measure Time</b>	
<b>Volume Overflow</b>	



## MAINTENANCE

Mandatory, routine or scheduled maintenance should not be required for the M5000 Mag Meter electronics or flow tube after proper installation.

However, some occurrences may require personnel to perform the following:

- Flow tube and electrode cleaning
- Circuit board replacement

### **⚠ WARNING**

**DO NOT CLEAN COMPONENTS INSIDE THE AMPLIFIER OR JUNCTION BOX.**

### **Cleaning the Flow Tube and Electrode**

At times flow tube, electrodes, amplifier/junction box housings and the amplifier window may need periodic cleaning, depending on process fluid properties, fluid flow rate and surrounding environment.

Clean the flow tube and electrodes by following the material handling and cleaning procedures documented in Material Safety Data Sheet (MSDS) guidelines for the products(s) that were in contact with the flow tube and electrodes.

Should flow tube and/or electrode cleaning become necessary:

1. Disconnect detector from pipeline.
2. Clean electrodes according to MSDS guidelines.
3. Reconnect detector to pipeline.

## TROUBLESHOOTING

The M5000 mag meter is designed for many years of optimal performance. However, should it malfunction, there are certain things that we recommend you check before contacting our Technical Support department or your local Badger Meter Representative.

**NOTE:** If the fluid measured has a high concentration of conductive solids, deposits may accumulate on the internal liner walls and electrodes. These deposits will cause a reduction of the measuring output. Thus, Badger Meter recommends that you remove the meter and inspect the liner and electrodes after six months. If deposits are found, remove them with a soft brush. Repeat inspection process every six months or until an appropriate inspection cycle can be established for the specific application. Other general conditions include:

Description	Possible Cause	Recommended Action
Flow is present but display is "0"	Disconnected signal cable.	Check signal cable.
	Detector mounted opposite of the main Flow direction (see arrow on the nameplate).	Turn detector 180° or switch terminal E1 and E2 or reprogram to bidirectional mode.
	Coil or electrode cables exchanged.	Check cable connections for cross wiring.
	Improper low flow cutoff or full scale flow.	Replace configuration defaults.
Inaccurate measuring	Improper calibration.	Check the parameters (detector factor and size) according to supplied data sheet.
	Wrong calibration parameter.	
	Pipe not fully filled, or air in pipe.	Check if meter is completely filled with fluid.
	Invalid fluid conductivity.	Purge line to eliminate air bubbles.
	Invalid fluid mixture.	
Blank display	Dead battery.	Replace battery.
Flow rate value known to be wrong	Detector factor.	Check value on label.
	Deposits on electrodes and/or liner.	Check and remove deposits.
	Incorrect pipe size programmed.	Check size if necessary.
Flow rate indication unstable	Cable issue.	Make sure cable is shielded and not vibrating.
	Grounding issue.	Make sure meter is properly grounded to a good earth ground.
	Partially full pipe.	Make sure pipe is full of fluid.
	Air in pipe.	Make sure fluid does not contain air bubbles.
	Invalid fluid conductivity.	Make sure amplifier is not too close to sources of electrical interference.
BEACON displays multiple estimated flow occurrences for meters connected to ORION Cellular LTE endpoints.	ORION Cellular LTE endpoints require additional resistance.	Add a 15K resistor to the M5000 terminal block. See <i>"Adding Resistor with ORION Cellular LTE"</i> on page 37.

## Errors & Warnings

What You See	Why It Happened	How to Fix It
MEASURE_TIMEOUT	The board may be damaged.	Contact Badger Meter Technical Support.
COMMON_MODE_VOLTAGE_OVERLOAD	Common mode voltage is smaller than -2.0V or larger than +4.1V.	Make sure the meter is properly grounded.
	Empty detector.	Switch Empty Pipe detection ON.
	Dirty electrodes.	Clean the electrodes.
EMPTY_PIPE_WARNING	Measured impedance between the Empty Pipe electrode and the Ground exceeded the set value.	<ul style="list-style-type: none"> <li>Make sure the pipe is filled.</li> <li>Check Empty Pipe threshold. It should be 60000 <math>\Omega</math> (corresponds with 20 <math>\mu\text{S}/\text{cm}</math>).</li> </ul>
	Empty detector.	
PULSE_OVERLOAD_WARNING	Overflow occurred on the flow output.	Lower the pulse number.
FLOW_OVERLOAD_WARNING	Flow exceeded the Full Scale of more than 100%.	Set the flow range properly.
LOW_POWER_WARNING	Battery voltage is smaller than 3.0V.	Consider replacing the battery.
EEPROM_ERROR	Configuration file is missing.	Replace the board.
CONFIG_ERROR	Configuration file is corrupted.	Replace the board.
PREAMPLIFIER_OVERLOAD	Input voltage exceeded the limits.	Maximum polarization is $\pm 227$ mV; maximum power line noise is 10.6 mV; maximum useful signal is 10.7 mV.
	Empty detector.	Switch Empty Pipe detection ON.
	Dirty electrodes.	Clean the electrodes.
COIL_ERROR	Coil/sensor is not connected.	<ul style="list-style-type: none"> <li>Make sure wiring is properly connected to the amplifier.</li> </ul>
	Coil shorted.	
	Issue with coil current.	<ul style="list-style-type: none"> <li>If that does not clear the alarm, contact Badger Meter Technical Support.</li> </ul>

## CONNECTING AN ORION RTR ENDPOINT TO THE M5000 METER

**NOTE:** Connect the endpoint as described. If there is a reading on the M5000, program the endpoint to match that reading or reset the totalizer. The endpoint will require programming per the endpoint user manual.

### Wiring

To connect the RTR endpoint to Output #1 on the M5000, connect the red wire to the positive (+) terminal and the black and green wire to the negative (-) terminal.

To connect the RTR endpoint to Output #2 on the M5000, connect the red wire to the positive (+) terminal and the black and green wire to the negative (-) terminal.

### Programming

To program the M5000 meter for the endpoint to Output #1 (forward flow):

1. Navigate to *IN/OUT > Simulat > Outputs > Puls/unit*.
2. Use the arrows to change the values, then press **EXIT/SAVE**.
3. Repeat steps 1 and 2 for *Width, Out 1 Func* and *Out 1 Type*.

To program the M5000 meter for the endpoint to Output #2 (forward flow):

1. Navigate to *IN/OUT > Simulat > Outputs > Puls/unit*.
2. Use the arrows to change the values, then press **EXIT/SAVE**.
3. Repeat steps 1 and 2 for *Width, Out 2 Func* and *Out 2 Type*.

## CONNECTING AN ORION ENCODER ENDPOINT TO THE M5000 METER

**NOTE:** Once connected, the endpoint automatically updates within one hour. You can force an update using the Endpoint Utility. See the Endpoint Utility user manual for programming information.

### Wiring

Connect the encoder endpoint to the meter:

Encoder Wire	M5000 Terminal
Red (Power/Clock)	Input +
Green (Data)	Out 4 +
Black (Ground)	Out 4 -

Connect a jumper wire from Out 4 negative (-) to INPUT negative (-).

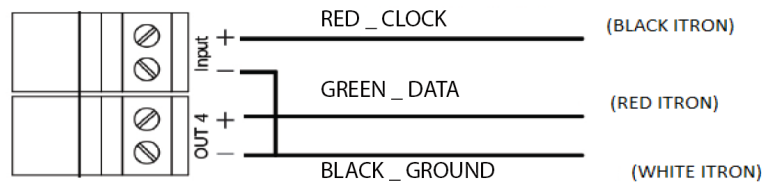

Figure 24: M5000 endpoint connection

### Adding Resistor with ORION Cellular LTE

When connected to an ORION Cellular LTE endpoint, additional resistance is required. Add a 15K resistor to the M5000 terminal block between Input + (red wire) and Out 4 + (green wire) as shown. The resistor is represented in red in *Figure 25*.



Figure 25: ORION Cellular LTE endpoint connection with resistor

Resistors, manufactured by Yageo, P/N MFR-25FBF52-15K, are available at these online electronic component distributors: [digkey.com](http://digkey.com) and [mouser.com](http://mouser.com).

### Programming

Changing the following settings automatically configures *Input* and *Output 4* for ADE.

To program the M5000 meter for the endpoint to Output #1 (forward flow):

1. Navigate to *METER SET > INTERFAC > ADE > CONTROL*.
2. Use the arrows to change the values, then press **EXIT/SAVE**.
3. Repeat steps 1 and 2 for *Control, Protocol, Dials* and *Resolution* (the *Resolution* range is 0.0001...10,000).
4. Press **EXIT/SAVE**.

## SPECIFICATIONS

<b>Flow Range</b>	0.1...32.8 ft/s (0.03...10 m/s)	
<b>Accuracy</b>	± 0.50 % rate for velocities greater than 1.64 ft/s (0.50 m/s), ± 0.008 ft/s (± 0.0025 m/s) for velocities less than 1.64 ft/s (0.50 m/s)	
<b>Minimum Fluid Conductivity</b>	≥ 20 micro siemens/cm	
<b>Pressure Limits</b>	Maximum allowable non-shock pressure and temperature ratings for steel pipe flanges, according to American National Standard ANSI B16.5. Examples: 150-lb flange, rated 285 psi at ambient temperature; 300-lb flange rated 740 psi at ambient temperature.	
<b>Fluid Temperature</b>	<b>With Remote Amplifier:</b> PTFE 302° F (150° C), Hard rubber 178° F (80° C)	<b>With Meter-Mounted Amplifier:</b> PTFE 212° F (100° C), Hard rubber 178° F (80° C)
<b>Ambient Temperature</b>	- 4...140° F (-20...60° C)	
<b>Flow Direction</b>	Uni-directional or bi-directional. Two separate programmable totalizers for uni-directional measurement.	
<b>Outputs (4 digital)</b>	Galvanically isolated open collector, 30V DC maximum, 20 mA each, maximum output frequency at 100 Hz	
<b>Outputs</b>	ADE, High/low flow alarm (0...100% of flow), error alarm, empty pipe alarm, flow direction	
<b>Communication</b>	RS232 Modbus RTU, IrDA	
<b>Empty Pipe Detection</b>	Field-tunable for optimum performance based on specific application	
<b>Min-Max Flow Alarm</b>	Programmable outputs 0...100% of flow	
<b>Low Flow Cut-Off</b>	Programmable 0...10% of maximum flow	
<b>Galvanic Separation</b>	Functional 50 volts	
<b>Pulse Width</b>	Programmable 5...500 ms	
<b>Coil Power</b>	Pulsed DC	
<b>Repeatability</b>	± 0.1%	
<b>Sampling Rate</b>	Programmable from 1 to 63 seconds. Standard sampling period is 15 seconds.	
<b>Display</b>	Two lines x 15 characters (7 on top + 8 on bottom), LCD display	
<b>Programming</b>	Three external buttons	
<b>Units of Measure</b>	Gallons, ounces, MGD, liters, cubic meters, cubic feet, imperial gallon, barrel, hectoliter and acre feet	
<b>Battery Life</b>	10 years	
<b>Power Supply</b>	Internal lithium batteries 3.6 volt	
<b>Processing</b>	Low power microcontroller (16 bit)	
<b>Amplifier Housing</b>	NEMA 4X (IP66), cast aluminum, powder-coated paint	
<b>Meter Housing Material</b>	Standard: Carbon steel welded	
<b>Pipe Spool Material</b>	316 stainless steel	
<b>Flanges</b>	Standard: ANSI B16.5 Class 150 RF Cast steel; <i>Optional</i> : 316 stainless steel & 300 lb cast steel	
<b>Liner Material</b>	PTFE 0.5...24 in., Hard rubber 1...24 in.	
<b>Electrode Materials</b>	Standard: Alloy C; <i>Optional</i> : 316 stainless steel	
<b>Mounting</b>	Detector-mount or remote wall mount (bracket supplied)	
<b>Meter Enclosure Classification</b>	NEMA 4X (IP66); <i>Optional</i> : Submersible NEMA 6P (IP67)-remote amplifier required	
<b>Junction Box Enclosure Protection</b>	For remote amplifier option: Powder coated die-cast aluminum, NEMA 4 (IP66)	
<b>NSF Listed</b>	Models with hard rubber liner 4 in. size and up; PTFE liner, all sizes.	
<b>Cable Entries</b>	1/2 in. NPT Cord Grip	
<b>Optional Stainless Steel Grounding Rings</b>	Meter Size	Thickness (of 1 ring)
	Up through 1 in.	0.135 in.
	12...24 in.	0.187 in.

**INTENTIONAL BLANK PAGE**

## Control. Manage. Optimize.

M-Series and ORION are registered trademarks of Badger Meter, Inc. Other trademarks appearing in this document are the property of their respective entities. Due to continuous research, product improvements and enhancements, Badger Meter reserves the right to change product or system specifications without notice, except to the extent an outstanding contractual obligation exists. © 2018 Badger Meter, Inc. All rights reserved.

**[www.badgermeter.com](http://www.badgermeter.com)**

---

**The Americas | Badger Meter** | 4545 West Brown Deer Rd | PO Box 245036 | Milwaukee, WI 53224-9536 | 800-876-3837 | 414-355-0400  
**México | Badger Meter de las Americas, S.A. de C.V.** | Pedro Luis Ogazón N°32 | Esq. Angelina N°24 | Colonia Guadalupe Inn | CP 01050 | México, DF | México | +52-55-5662-0882  
**Europe, Eastern Europe Branch Office (for Poland, Latvia, Lithuania, Estonia, Ukraine, Belarus) | Badger Meter Europe** | ul. Korfantego 6 | 44-193 Knurów | Poland | +48-32-236-8787  
**Europe, Middle East and Africa | Badger Meter Europa GmbH** | Nurtlinger Str 76 | 72639 Neuffen | Germany | +49-7025-9208-0  
**Europe, Middle East Branch Office | Badger Meter Europe** | PO Box 341442 | Dubai Silicon Oasis, Head Quarter Building, Wing C, Office #C209 | Dubai / UAE | +971-4-371 2503  
**Slovakia | Badger Meter Slovakia s.r.o.** | Racianska 109/B | 831 02 Bratislava, Slovakia | +421-2-44 63 83 01  
**Asia Pacific | Badger Meter** | 80 Marine Parade Rd | 21-06 Parkway Parade | Singapore 449269 | +65-63464836  
**Switzerland | Badger Meter Swiss AG** | Mittelholzerstrasse 8 | 3006 Bern | Switzerland | +41-31-932 01 11