



LectroCount LCR 600 | Setup and Operation



TABLE OF CONTENTS

INTRODUCTION	
Software License Agreement	3
LectroCount LCR 600 Overview	4
Instruments and Controls	6
LectroCount LCR 600 Navigation	11
Security	18
Point-of-Sale Activation	20

SETUP	
Setup Overview	22
General Setup	22
System Setup	24
Calibration Setup	27
Point-of-sale (POS) Setup	36
Tax Categories	37
Cash Discounting	38
Volume Discounting	39
Miscellaneous Charges	40
Setup POS (Creating Products)	41

OPERATION	
Operation Overview	44
Making a Delivery	44
Delivery Screens	45
Preset Deliveries	46
Packing the Hose	47
Tickets	48

DIAGNOSTICS AND TROUBLESHOOTING	
Diagnostics and Troubleshooting Overview	54
Error Messages	54
Diagnostics	56
Machine Status	57
Printer Status	58
Delivery Status	59
Delivery Code	60
Diagnostic Ticket	62
Troubleshooting	63
LectroCount LCR 600 Inputs & Outputs	66

Publication Updates and Translations

The most current English versions of all Liquid Controls publications are available on our web site, www.lcmeter.com. It is the responsibility of the local distributor to provide the most current version of LC manuals, instructions, and specification sheets in the required language of the country, or the language of the end user to which the products are shipping. If there are questions about the language of any LC manuals, instructions, or specification sheets, please contact your local distributor.

SOFTWARE LICENSE AGREEMENT

Read this license carefully. You agree that by using the itemized software package, you have agreed to the software license terms and conditions. This agreement constitutes complete and entire agreement between you and Liquid Controls with respect to this product.

1. Liquid Controls hereby grants to Licensee a non exclusive license to use SR60 and SR600POS (hereinafter referred to as "Licensed Software")
2. Under the License granted herein, Licensee may use the itemized machine readable (executable code) copy of the Software, including any subsequent updates which may be provided. Licensee shall not, without Liquid Controls' prior written consent, (a) rent, lease, lend, sublease or otherwise transfer the materials hereunder; (b) remove or obscure proprietary or copyright notices which may be set forth on the Licensed Software; or (c) alter, decompile, or disassemble the program.
3. One (1) copy of the Licensed Software, including any software distributed on disks may be made for backup purposes only. No other copies may be made or used without the written consent of Liquid Controls.
4. Title. No title to ownership of any Licensed Software is transferred to the Licensee.
5. Upgrades. License upgrades may become available for the Licensed Software. Any cost associated with such upgrades will solely be determined by Liquid Controls.
6. Warranty. Liquid Controls makes and licensee receives no warranty express or implied and there are expressly excluded all warranties of merchantability and fitness for a particular purpose.
7. Limitation of Liability. Licensee shall have the sole responsibility for adequate protection and backup of its data in connection with the Licensed Software. In no event shall Liquid Controls be liable for (a) special, indirect or consequential damages; (b) any damages whatsoever resulting from loss of use, data, or profits, product, inaccurate input or work delays, or any direct property damage arising out of or in connection with this agreement or the use or performance of the Licensed Software.
8. Termination. Liquid Controls may terminate this software license granted hereunder and require return of the Licensed Software if Licensee fails to comply with these license terms and conditions.
9. Licensee acknowledges that it has read this agreement, understands it, and agrees to be bound by its terms, and further agrees that this is the complete and exclusive statement of the agreement between Liquid Controls and Licensee, which supersedes and merges all prior proposals, understandings, and all other agreements, oral or written, between the parties relating to this agreement. This agreement may not be modified or altered except by written instrument duly executed by both parties.
10. This Agreement and performance hereunder shall be construed and interpreted under the laws of the State of Illinois.
11. If any provision of this agreement is invalid under any applicable statute or rule of law, it is to that extent to be deemed omitted.
12. Licensee may not assign or sublicense, without the prior written consent of Liquid Controls, its rights, duties, or obligations under this Agreement to any person or entity in whole or in part.
13. The waiver or failure of Liquid Controls to exercise in any respect any right provided herein shall not be deemed a waiver of any further right hereunder.

⚠ WARNING

- Before using this product, read and understand the instructions.
- Save these instructions for future reference.
- All work must be performed by qualified personnel trained in the proper application, installation, and maintenance of equipment and/or systems in accordance with all applicable codes and ordinances.
- Failure to follow the instructions set forth in this publication could result in property damage, personal injury, or death from fire and/or explosion, or other hazards that may be associated with this type of equipment.

LectroCount LCR 600 Overview

GENERAL INFORMATION

This manual provides instructions for the initial setup, the calibration, and the operation of the LectroCount LCR 600. The Liquid Controls LectroCount LCR 600 is a microprocessor-based electronic meter register. Its primary functions consists of configuring the meter system to the properties of the liquids to be measured, interfacing with the electronic components of the meter system components (and external components such as pumps, injectors, and shutdown devices), and performing Weights & Measures approved custody transfer actions.

The LCR 600 performs well in mobile and fixed installations. It can control a meter system as a stand-alone unit or used as a slave to a host controller such as a process controller or an in-cab data management system.

The LCR 600 is a self-contained unit. All operation, setup and configuration functions can be entered using the LCR 600's red selector switch and the alphanumeric keypad. No lap pads, laptops, or other data entry devices are required.

A point-of-sale upgrade or POS is available for the LCR 600. The POS upgrade gives the LCR 600 the ability to print tickets with pricing, taxes, discounts, and miscellaneous charges at delivery sites.

BASIC FUNCTIONS

- Calibration (single and multipoint)
- Weights & Measures custody transfer (product delivery and ticket generation)
- Metrological data collection
- Presetting by volume
- Multiple production selection
- Four delivery screens
- Security settings
- Air and vapor elimination (with proper accessories)
- Valve control (with proper accessories)
- Electronic temperature volume compensation (ETVC) (with proper accessories)

POS UPGRADE FUNCTIONS

- Cash and volume discounting
- Multiple tax structures
- Priced and taxed tickets
- 16 product calibrations
- 100 product names
- Presetting by price

LectroCount LCR 600 Inputs and Outputs

The LCR 600 can communicate with a number of components on a Liquid Controls meter system. The following pages provide a brief description of the components, a drawing identifying these components on the meter system, and a list of the LCR 600 commands and fields that correspond to each component.

INTERNAL PULSER

Typically, an internal pulser is mounted to the bottom of the LCR 600 housing. A small shaft extends from the bottom of the internal pulser through the LCR 600 housing where it attaches to a drive shaft. The drive shaft turns directly off of the rotors inside the Liquid Controls meter. When the internal pulser shaft spins, the pulser manufactures a two channel quadrature pulse output. The LCR 600 uses the pulse output to calculate flow measurements. The number of pulses equal to a unit of measurement is set during calibration and proving in the **Pulse/Unit <k-Factor>**: field.

TEMPERATURE PROBE

The optional temperature probe, part of the Electronic Temperature Volume Compensation (ETVC) kit, monitors the temperature of the product being measured. Because the volume of many products expand and constrict considerably according to temperature fluctuations, the LCR 600 corrects the volume measurement to a base temperature (60° F for example).

PRINTER

Together, the LCR 600 and the Epson printer can print out four types of tickets (delivery, duplicate delivery, shift, and diagnostic). With the LCR 600 POS upgrade, delivery tickets can be configured to print completely priced tickets with complex tax and discount structures. The LCR 600 provides a “require ticket feature” to meet Weights & Measures standards and prevent unrecorded deliveries.

S1 SOLENOID

When energized by the LCR 600, the S1 solenoid-operated valve opens the control valve on the outlet side of the meter, allowing product to flow through the valve. When the S1 is deenergized, the control valve shuts off the product flow. The LCR 600 switches the S1 solenoid via the selector switch (RUN and STOP positions) and during two stage preset deliveries (according to the **s1 Close:** value).

S2 SOLENOID

The S2 solenoid-operated valve is used by two stage meter systems to provide a dwell flow for preset deliveries. Near the end of a two stage preset delivery, the LCR 600 de-energizes the S1 solenoid-operated valve to stop product flow. At the same time, the LCR 600 energizes the S2 solenoid to open a bypass pipe through which the remainder of the preset delivery

passes. The solenoids are switched at a preset remaining volume or price determined by the value of the LCR 600 field **s1 Close:**.

S3 SOLENOID

The S3 solenoid opens and close the vent ports of the meter system’s optical air (or vapor) eliminator. The LCR 600 energizes and de-energizes the S3 according to the optical sensor’s reading.

OPTICAL SENSOR

An optical sensor detects the presence of liquid inside optical air (or vapor) eliminators. When the optical sensor does not detect liquid inside the optical air (or vapor) eliminator cavity, the LCR 600 de-energizes the S1 solenoid-operated valve and causes the control valve to close. At the same time, the optical sensor energizes the S3 solenoid-operated valve, opening the vent ports. As the air and vapor evacuates the cavity, the liquid level rises. When the level reaches the optical sensor, the sensor detects the liquid. The LCR 600 energizes the S1 solenoid, which opens the control valve, and deenergizes the S3 solenoid, sealing the vent ports.

ΔP TRANSDUCER

The differential pressure transducer, common in aviation applications, monitors the differential pressure (pressure drop) across a full flow fuel monitor/water coalescer. The highest differential pressure reached during the custody transfer is printed on the delivery ticket and displayed on the screen. If the differential pressure reaches a dangerous level, the LCR 600 can shut down the delivery. To set up a differential pressure shutdown value, a shutdown device (such as a valve or a dead-man) must be connected to the LCR 600, and a differential pressure shutdown value must be entered into the **dP Shutdown Value:** field.

AUXILIARY OUTPUTS

The LCR 600 provides three open drain transistor auxiliary outputs for different external devices such as pump controls and additive injectors. Two of the outputs have settings that can be set in the **Auxiliary 1 Output:** (Off, On, On During Delivery, and Monitor Flowrate) and **Auxiliary 2 Output:** (Off, On, On During Delivery, and Flow Direction) fields. The LCR 600 also provides auxiliary output connections for the LectroCount Remote Display (other types of displays are usually compatible). Signals from these outputs duplicate the volume data sent to the LCR 600 display.

INTRODUCTION - LCR 600 INSTRUMENTS AND CONTROLS

Red Selector Switch

The LCR 600 red selector switch, located at the bottom left of the LectroCount LCR 600, has five positions. The selector switch's primary purpose is to control everyday delivery and print functions. Functions include opening and closing the control valve in order to start and stop deliveries and prompting the printer to print delivery tickets and shift tickets.

THE FIVE POSITIONS ON THE SELECTOR SWITCH

- RUN** - opens the control valve to begin a delivery
- STOP** - closes the control valve to pause a delivery
- PRINT** - ends a delivery and prints a delivery ticket
- SHIFT PRINT** - ends a shift, prints a shift ticket, and resets shift data in the LCR 600
- Calibration Position** - allows access to calibration configuration settings.

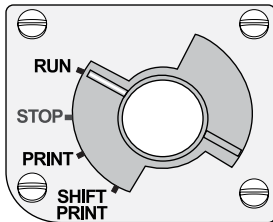

Red Selector Switch

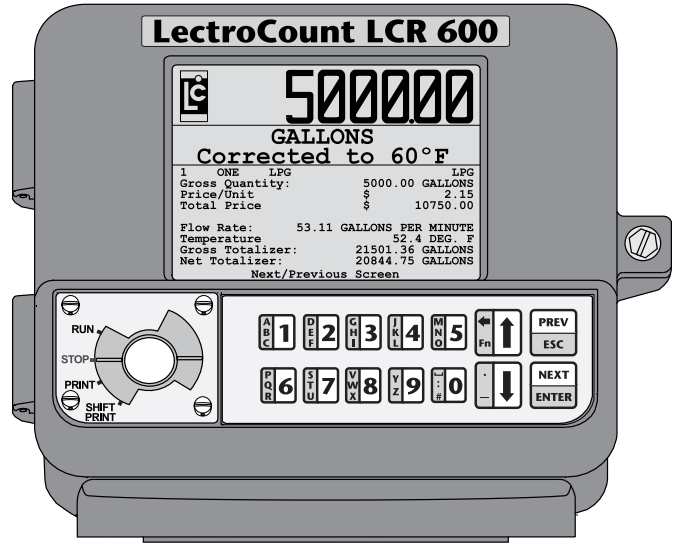

LCR 600

CALIBRATION POSITION

The red selector switch also provides a secure calibration position. When in the calibration position, the LCR 600 may be used to calibrate the meter and enter sensitive Weights & Measures data.

To turn the selector switch into the six o'clock calibration position, the LCR 600's switchplate must be removed. To take off the switchplate, remove the four screws holding it in place. If the LCR 600 has been previously calibrated and approved by Weights & Measures, you will need to remove the lead seal and the wire threaded through the switchplate screws.

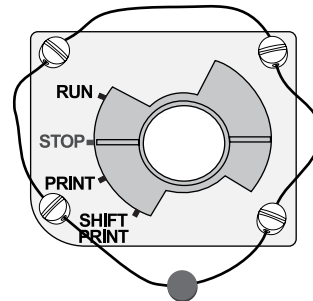

Selector Switch & Seal

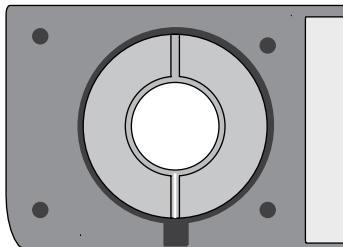

Six O'clock Calibration Position

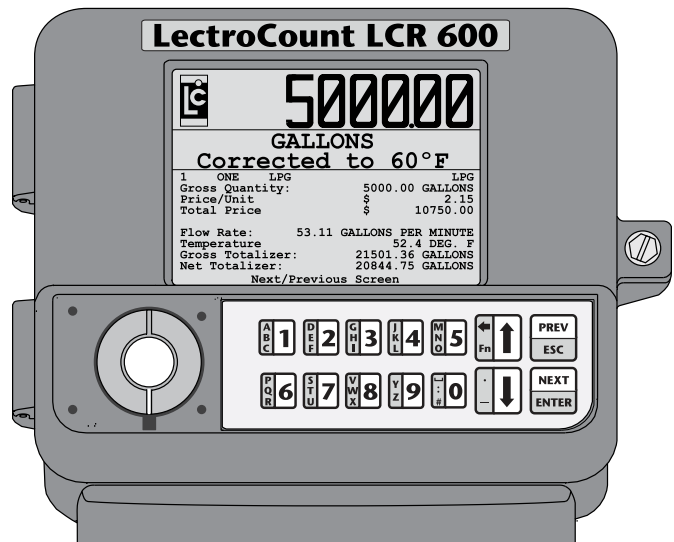

LCR 600 without Switchplate

Alphanumeric Keypad

The alphanumeric keypad serves as a navigation and data entry tool for the LCR 600. The four larger buttons on the right side of the keypad are used primarily for navigating to fields on the display screen and navigating from one display screen to the next. The ten smaller buttons on the left side are used to enter numbers, characters, and text when changing the value of a field.

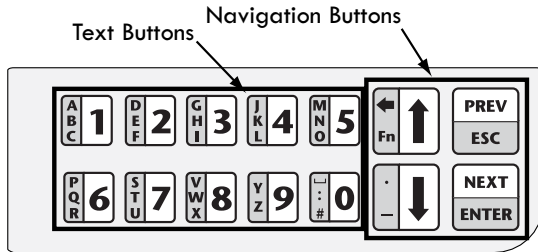

LCR 600 Alphanumeric Keypad

Display Screens

LCR 600 display screens can contain up to 16 fields. The values of most LCR 600 fields can be edited; however, some fields are shown for data monitoring and informational purposes only and can not be edited, for example **Temperature** and **Flow Rate**.

SELECTING FIELDS

To select a field for editing, the LCR 600 display screens use a pointer that scrolls up and down along the left side of the screen. If the field is not editable, the pointer will skip over it.

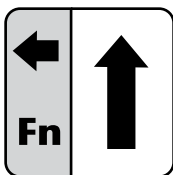
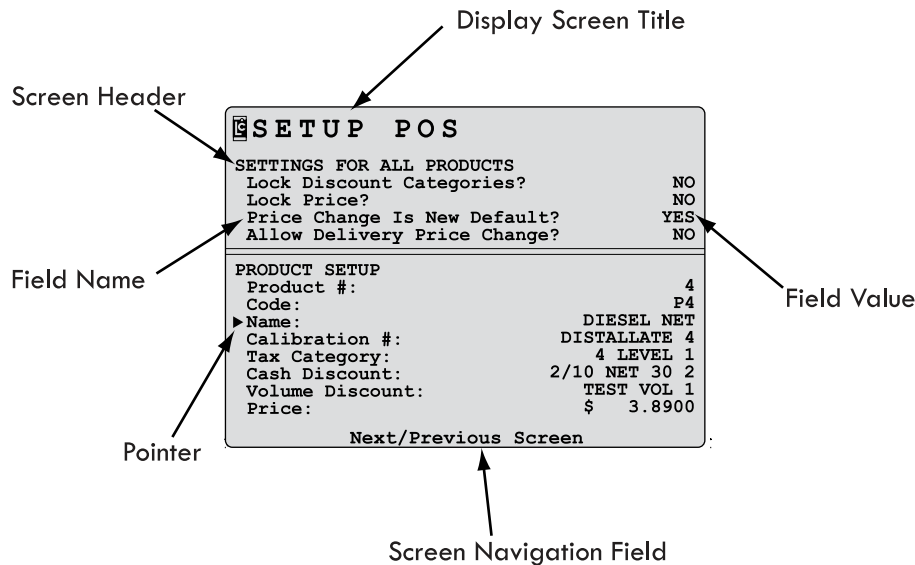

Arrow Button to scroll the pointer up the left side of the display

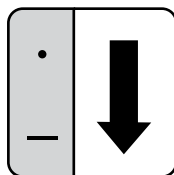

Arrow Button to scroll the pointer down the left side of the display

To select a field on a display screen:

1. Move the pointer ► on the far left of the display to the desired field using the ↑ and ↓ buttons.
2. Press the **ENTER** button to open a list box or a field edit box.

After a field is selected, the LCR 600 will bring up a list box or a field edit box, depending on the field, where the value of the field can be changed.

INTRODUCTION - LCR 600 INSTRUMENTS AND CONTROLS

LIST BOX WINDOWS

Some LCR 600 fields only have a limited number of possible values. These fields use list box windows to display all of the possible values.

To select a value in a list box:

1. Move the pointer ► to your desired value using the ↑ and ↓ buttons.
2. Press the **ENTER** button to accept the value.

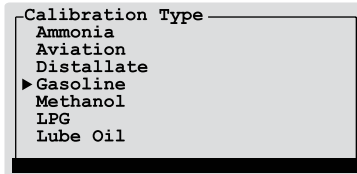

Calibration Type List Box



Press the **PREV/ESC** button to exit any list box or field edit window with changing its value

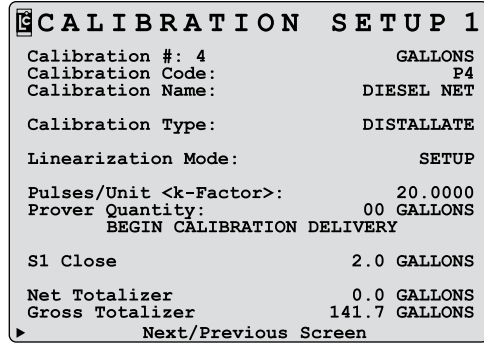

Calibration Screen
Pointer on the Calibration Type field

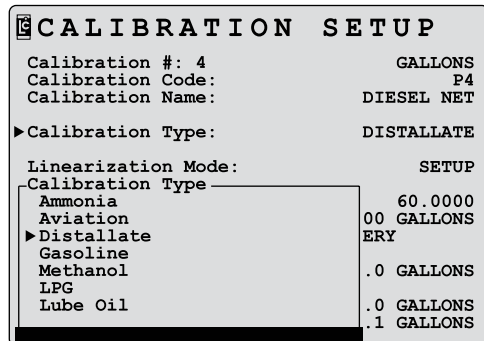

List Box Window after selecting Calibration Type field

Throughout this manual, the type of edit box for LCR 600 field is included with the field definition.

FE - Field Edit Box
LB - List Box

FIELD EDIT WINDOWS

Some LCR 600 fields require a specific alphanumeric entry. For these fields, the LCR 600 will open a small box at the bottom of the screen where text, numbers, and characters can be entered using the keypad.

To enter a value in a field edit box:

1. Enter text, numbers, or characters using the multitap functionality of the keypad's 10 alphanumeric buttons.
2. Press the **ENTER** button to accept the value.

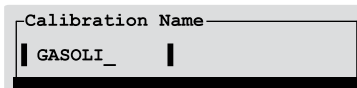

Calibration Name Field Edit Box

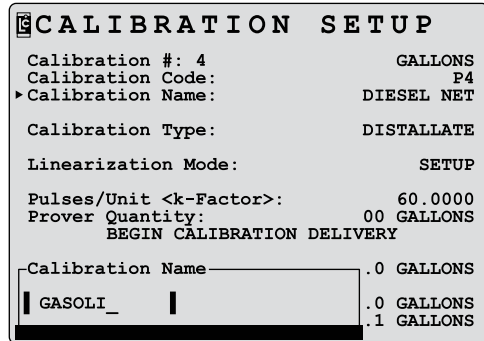

Field Edit Window after selecting Calibration Name field

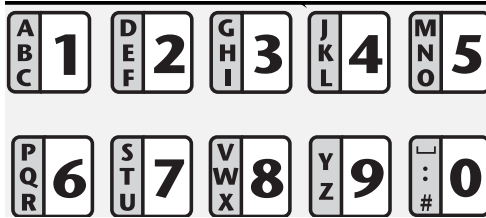

Alphanumeric Buttons

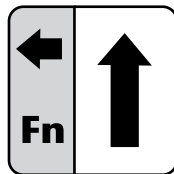

Press the  button to backspace in a field edit window

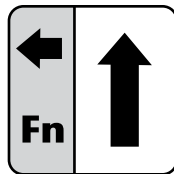

Fn Button

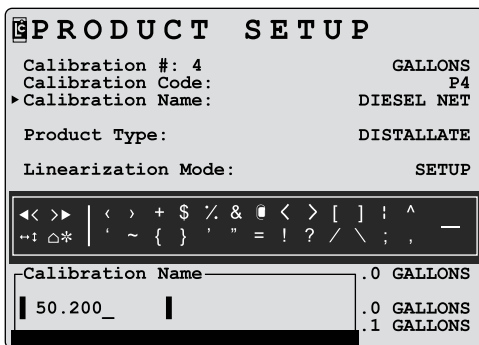

Display Screen with Fn Box

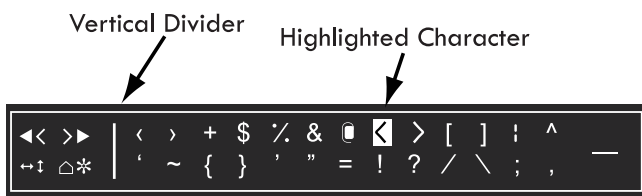

Fn Box

MULTITAP FUNCTIONALITY

While a field edit box is on the LCR 600 screen, the alphanumeric buttons and the down button can be used to enter characters in the field edit box. The character entered into the field edit box depends on the number of times the button is pressed successively, similar to text messaging on a cell phone.

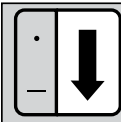

	TAPS	CHARACTER
	1	8
	2	V
	3	W
	4	X

	TAPS	CHARACTER
	1	.
	2	-









Fn BOX

The Fn command (on the up arrow button) provides a set of additional characters and commands that can be entered in a field edit box. The symbols on the left side of the Fn box are commands. The symbols on the right side are characters.

To activate an Fn command or insert an Fn **character**:

1. Tap the Fn button twice to bring up the Fn box.
2. Using the  and  buttons, move the highlighted cursor to the desired command or character
3. Press the **ENTER** button to accept the highlighted command or character.

FN COMMANDS

-  Moves cursor to the farthest left position
-  Moves cursor one space to the left
-  Moves cursor one space to the right
-  Moves cursor to the farthest right position
-  Insert toggle
-  Upper/Lower case toggle
-  Deletes character above cursor
-  Deletes entire field

INTRODUCTION - LCR 600 INSTRUMENTS AND CONTROLS

NAVIGATING FROM SCREEN TO SCREEN

The LCR 600 contains nine groups of screens: Delivery Setup, General Setup, System Setup, Calibration Setup, Diagnostics, Security, Setup POS, Advanced Features, and Machine Status. Once a group of screens is opened, you can rotate through the screens in the group using the **Next/Previous Screen** field at the bottom of the screen.

Two additional screens, independent of the nine groups, are essential to operating and navigating the LCR 600, the Delivery Screen and the Configuration Menu.

The Delivery Screen is opened when the red selector switch is turned to the RUN position. Once the Delivery Screen is open, the three Delivery Setup screens can be opened using the **Next/Previous Screen** field. The Configuration Menu serves as a hub for opening the other eight groups of screens. It is included in the rotation of each group of screens. The Configuration Menu also opens when the red selector switch is turned to the calibration position.

To move from one screen to another:

1. Move the pointer to the bottom line of the screen: **Next / Previous Screen**
2. Press the **NEXT** or the **PREV** button to navigate to the next screen or the previous screen.

----- OR -----

1. Move the pointer to any field in the Configuration Menu screen.
2. Press the **ENTER** button to open the screen.

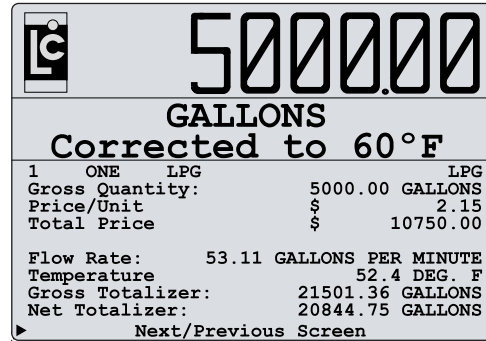

The screenshot shows a delivery screen with a large digital display at the top showing '5000.00' gallons. Below the display, it says 'GALLONS Corrected to 60°F'. The screen lists various fuel metrics:

1	ONE	LPG	LPG
Gross Quantity:	5000.00	GALLONS	
Price/Unit	\$	2.15	
Total Price	\$	10750.00	
Flow Rate:	53.11	GALLONS PER MINUTE	
Temperature	52.4	DEG. F	
Gross Totalizer:	21501.36	GALLONS	
Net Totalizer:	20844.75	GALLONS	

At the bottom, there is a field labeled 'Next/Previous Screen' with a right-pointing arrow.

*Delivery Screen Pointer
on the Next/Previous Screen line
in position for a screen change*



*Press NEXT/ENTER button while pointer
is on the Next/Previous Screen line
to navigate to the next screen*



*Press PREV/ESC button while pointer
is on the Next/Previous Screen line
to navigate to the previous screen*

Delivery Screen Fail-safe

*In any LCR 600 screen, turning the selector switch to RUN will
bring up the delivery screen and begin a delivery.*

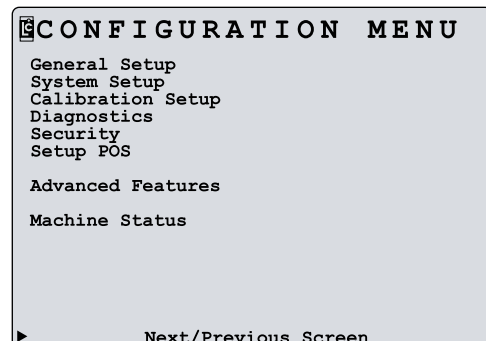

The screenshot shows the 'CONFIGURATION MENU' screen. It lists several menu options:

- General Setup
- System Setup
- Calibration Setup
- Diagnostics
- Security
- Setup POS
- Advanced Features
- Machine Status

At the bottom, there is a field labeled 'Next/Previous Screen' with a right-pointing arrow.

Configuration Menu

Delivery Screens

Detailed Pump & Print • Aviation • Volume & Preset

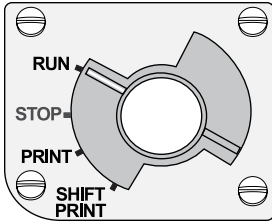

To navigate to the delivery screens:

1. Set the selector switch to RUN, and the delivery screen will appear and start a delivery. -OR- While the selector switch is set to STOP, PRINT, or SHIFT PRINT navigate to the Configuration Menu.
2. Move the pointer to the **Next/Previous Screen** field and press the **NEXT** or **PREV** button.

```

LC 116
GALLONS
Corrected to 60 ° F
3 PL1 LPG1          LPG
Net Preset:         0.00 GALLONS
Temperature:        72.9 DEG. F
Flow Rate:          0.0 GALLONS PER MINUTE
Net Totalizer:      1538.74 GALLONS
Gross Totalizer:   1601.11 GALLONS
Next/Previous Screen
    
```

```

LC DELIVERY SETUP 1
1 PT1 GAS 91          GASOLINE
Calibration Code:    PT1
Calibration Name:    GAS 91
Preset Type:         CLEAR
Net Preset:          0.0 GALLONS
Gross Preset:        20.0 GALLONS
Price/Unit:          2.7790
Tax/Unit:             0.0000
Percent Tax:         6.75
Total Price:         55.48
No-Flow Timer        180
Net Quantity:        0.0 GALLONS
Gross Quantity:      18.7 GALLONS
Next/Previous Screen
    
```

```

LC DELIVERY SETUP 2
1 PT1 GAS 91          GASOLINE
Auxiliary 1 Output:  ON DURING DELIVERY
Auxiliary 2 Output:  FLOW DIRECTION
Toggle Flow Rate:    0.0
Ticket Header Text
1: MURPHY TANK
2: 45557 HARWICK HIWAY
3: CONRAD, MONTANA 59425
4:
5:
6:
7:
8:
9:
10:
Next/Previous Screen
    
```

```

LC DELIVERY SETUP 3
1 PT1 GAS 91          GASOLINE
Shift Start:         06/29/09 17:36:57
Deliveries:          4
Shift Net:            0.0 GALLONS
Shift Gross:         62.8 GALLONS
Clear Shift?         NO
Net Totalizer:
Gross Totalizer:    141.77 GALLONS
Next/Previous Screen
    
```

```

LC CONFIGURATION MENU
General Setup
System Setup
Calibration Setup
Diagnostics
Security
Setup POS
Advanced Features
Machine Status
Next/Previous Screen
    
```

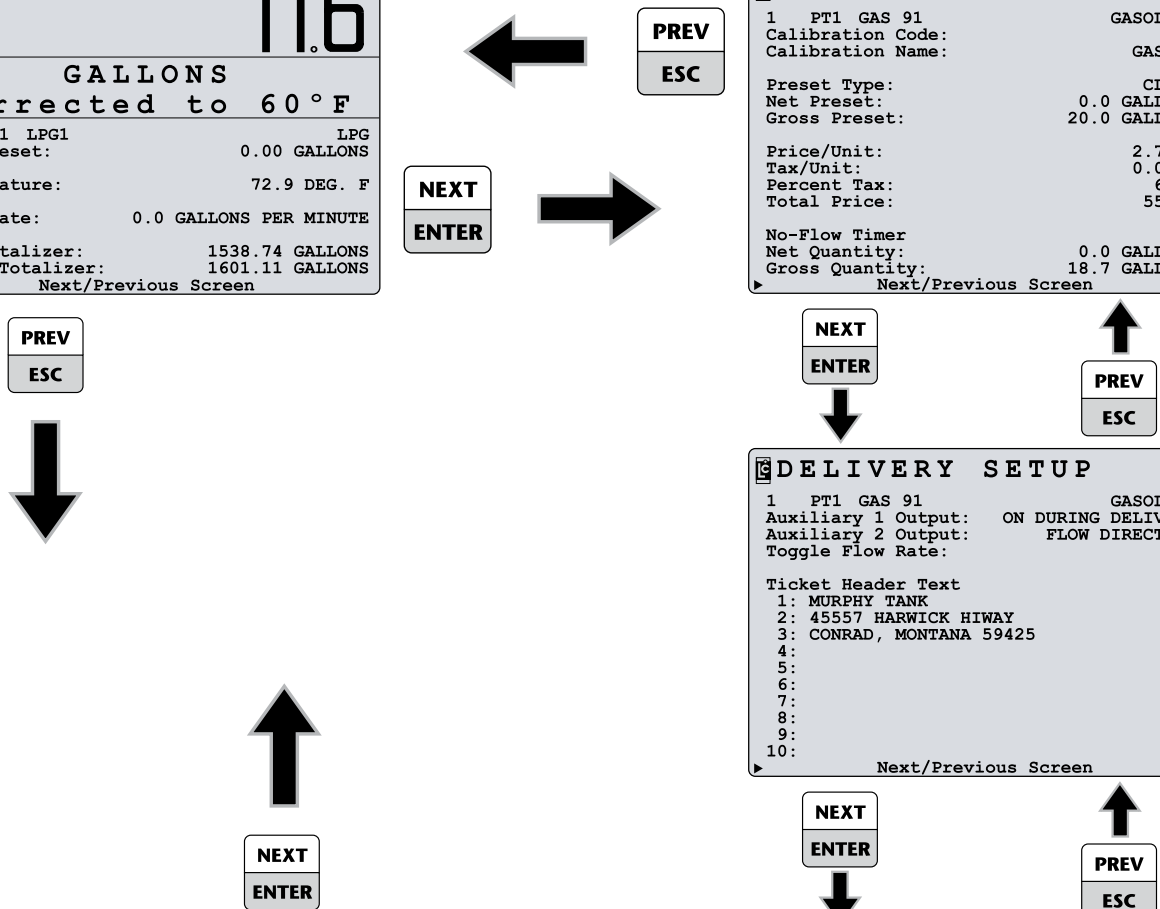

POS Delivery Screens

Detailed POS • Aviation • Volume & Preset

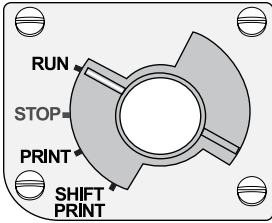

To navigate to the POS delivery screens:

1. Set the selector switch to RUN, and the delivery screen will appear and start a delivery. -OR- While the selector switch to STOP, PRINT, or SHIFT PRINT and navigate to the Configuration Menu.
2. Move the pointer to the **Next/Previous Screen** field and press the **NEXT** or **PREV** button.

```

LC 34.1
GALLONS

2 PD1 DIESEL          DISTALLATE
Product #: P4         DIESEL NET 4
Gross Preset:         0.0 GALLONS
Price Preset:         $ 0.00
Price/Unit:           $ 3.8900
Total Price Including Tax: $ 155.60

Flow Rate:           35.8 GALLONS PER MINUTE
Add Miscellaneous Charges
Next/Previous Screen
    
```

```

DELIVERY SETUP 1
Gross Quantity:      34.1 GALLONS
2 PD1 DIESEL NET    DISTALLATE
Product #: PD4      DIESEL NET 4
Gross Preset:       0.0 GALLONS
Price Preset:       $ 0.00
Price/Unit:         $ 3.8900
Tax Code:           DARK CO.
Volume Discount:    1
Cash Discount:      EARLY PAYMENT

Auxiliary 1 Output: ON DURING DELIVERY
Auxiliary 2 Output: FLOW DIRECTION
Toggle Flow Rate:   0.0
Preset Type:        CLEAR
No-Flow Timer:      180
Add Miscellaneous Charges
Next/Previous Screen
    
```



```

DELIVERY SETUP 2
Gross Quantity:      34.1 GALLONS
2 PD1 DIESEL        GASOLINE
Product #: P4       DIESEL NET 4
Gross Preset:       0.0 GALLONS
See All Product Pricing
Ticket Header Text
1: Murphy Tank
2: 45557 Harwick Hiway
3: Conrad, Montana 59425
4:
5:
6:
7:
8:
9:
10:
Next/Previous Screen
    
```



```

CONFIGURATION MENU
General Setup
System Setup
Calibration Setup
Diagnostics
Security
Setup POS

Advanced Features

Machine Status

Next/Previous Screen
    
```

```

DELIVERY SETUP 3
2 PD1 DIESEL          DISTALLATE

Shift Start:         06/29/09 17:36:57

Deliveries:         4
Shift Net:           0.0 GALLONS
Shift Gross:        152.8 GALLONS

Clear Shift?        NO

Net Totalizer:      0.0 GALLONS
Gross Totalizer:    1455.89 GALLONS
Next/Previous Screen
    
```

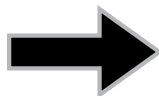

General Setup Screens

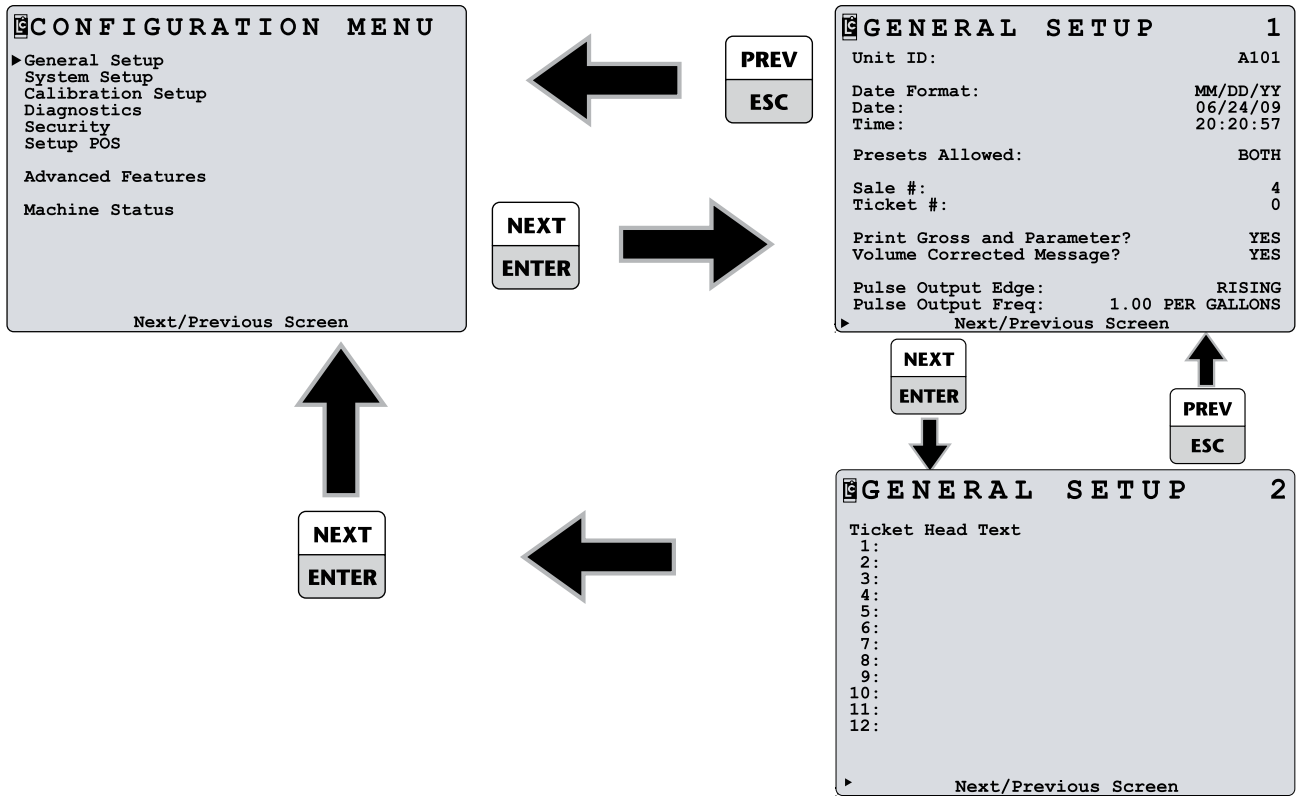

System Setup Screens

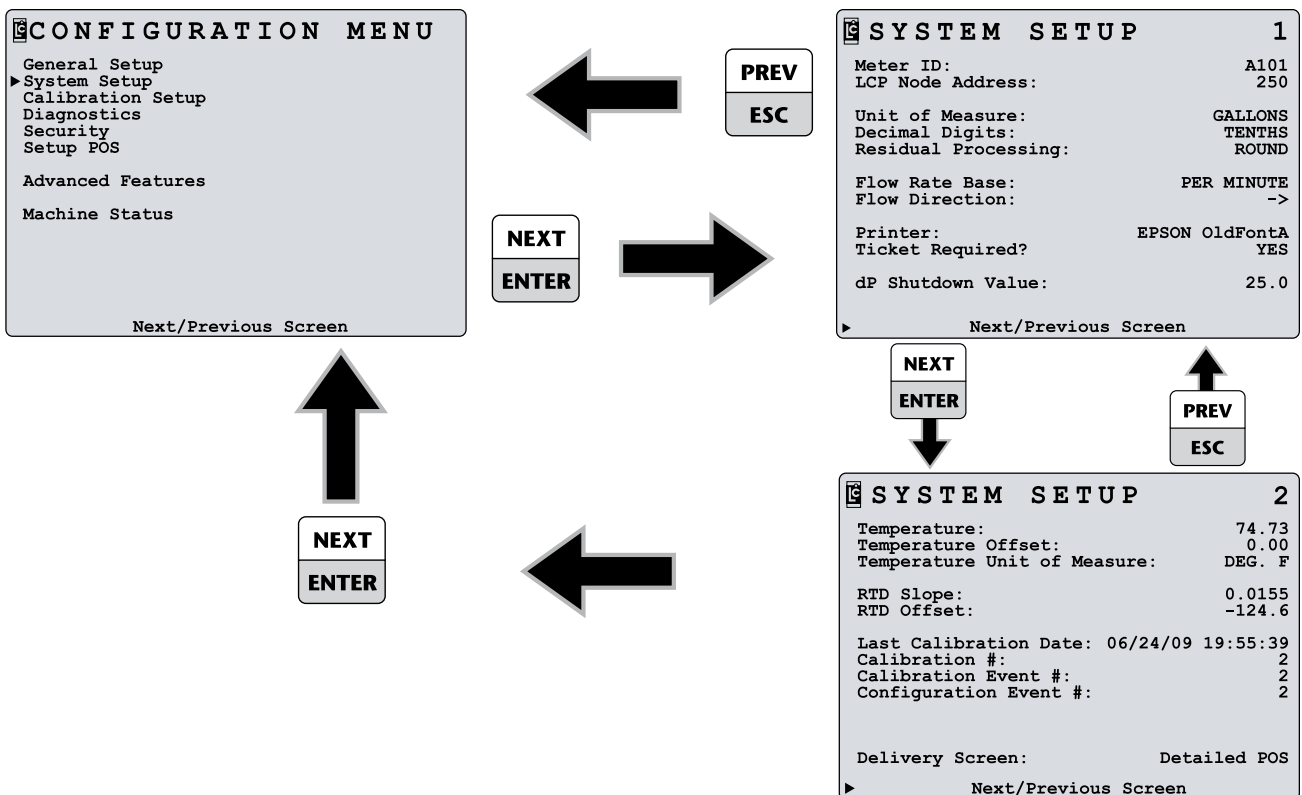

Calibration Setup Screens

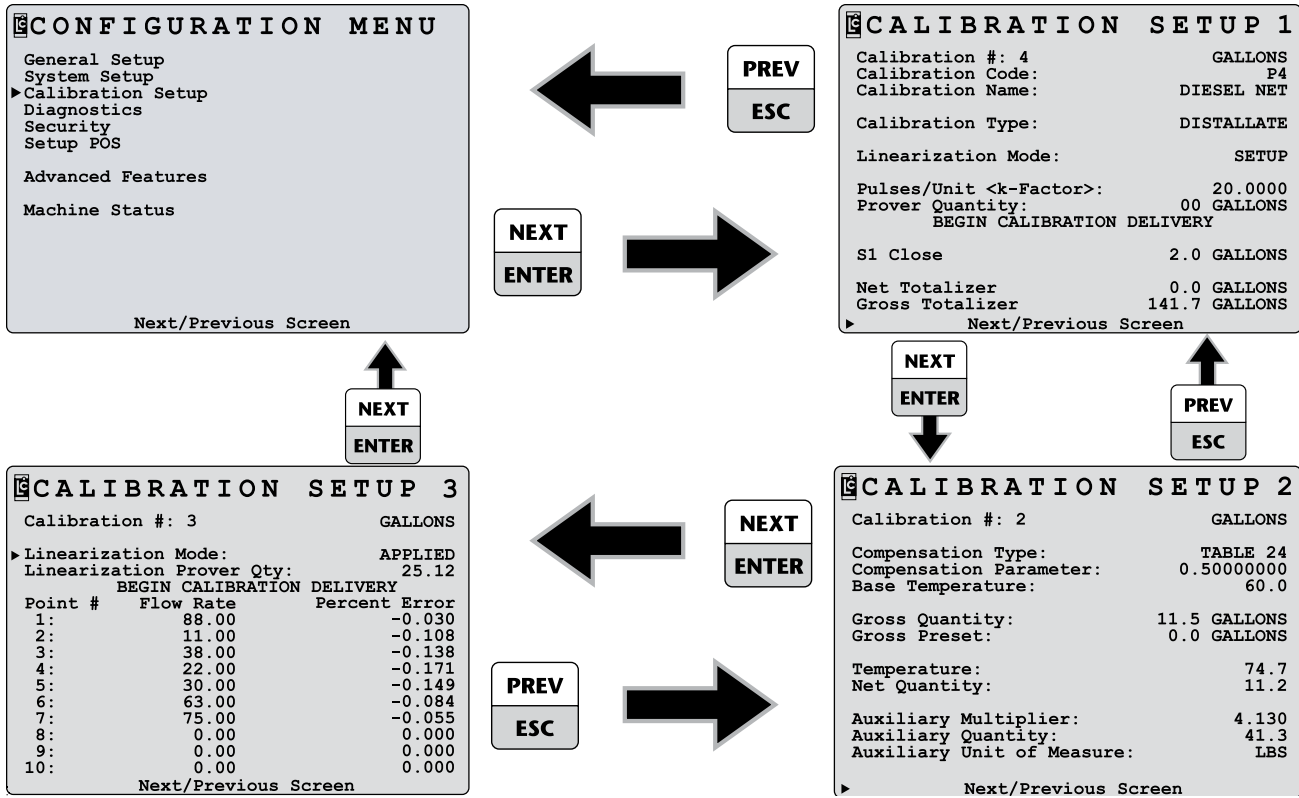

Diagnostics Screen

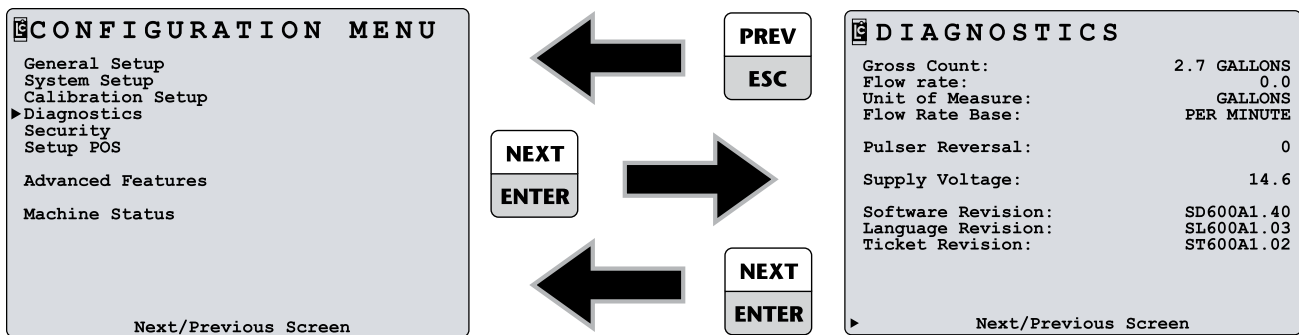

Security Screen

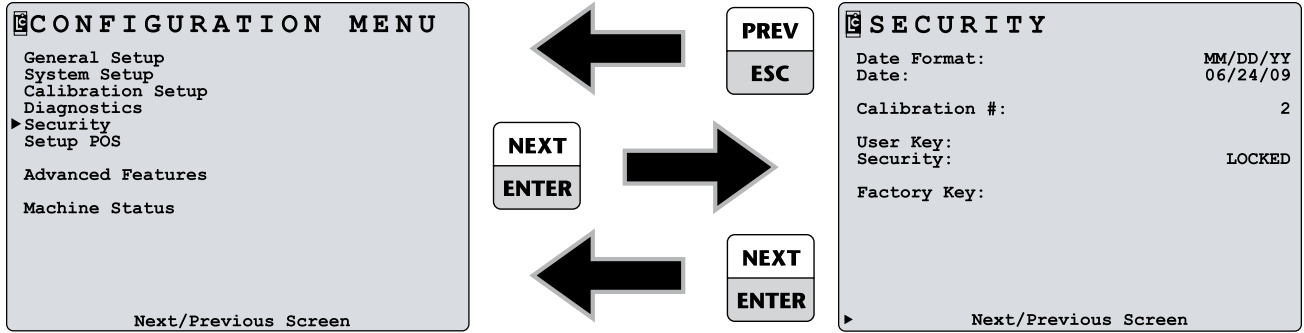

Setup POS Screens

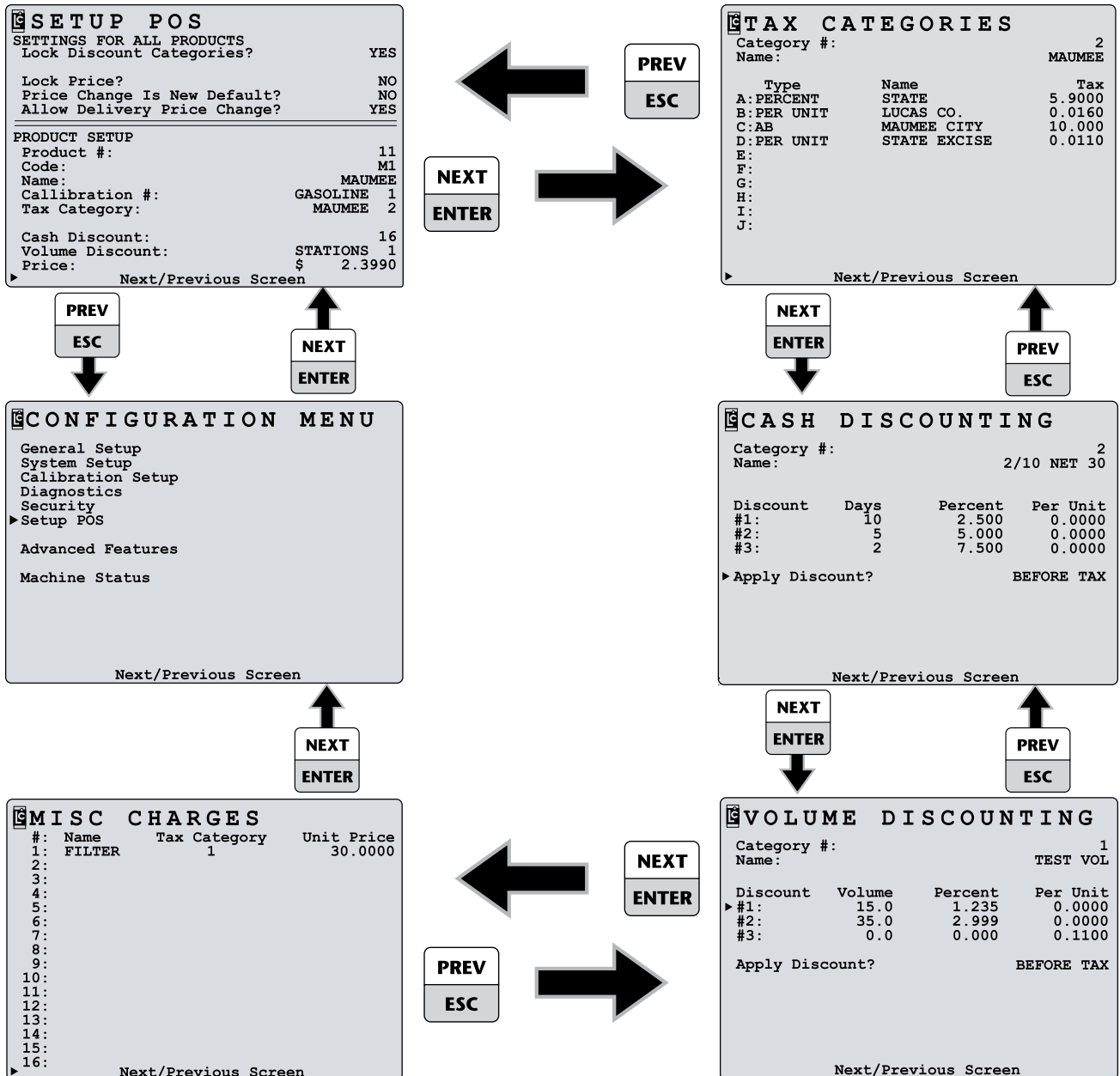

Advanced Features Screen

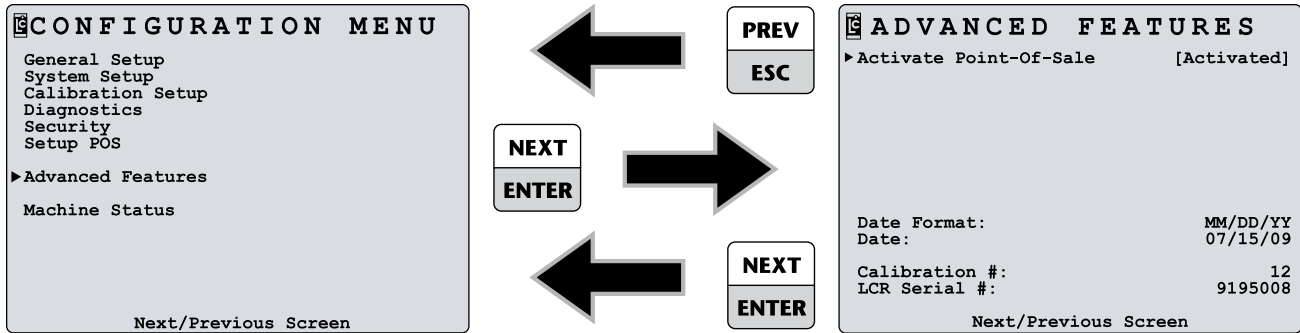

Machine Status Screen

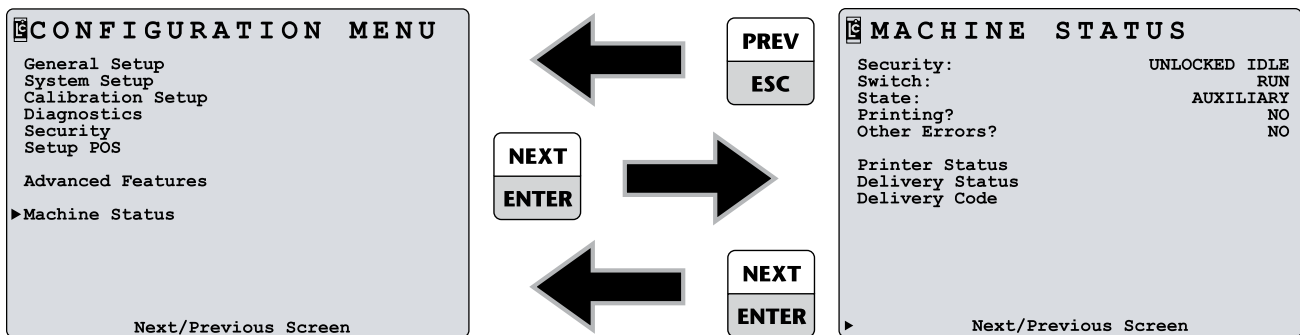

Printer Status Screen

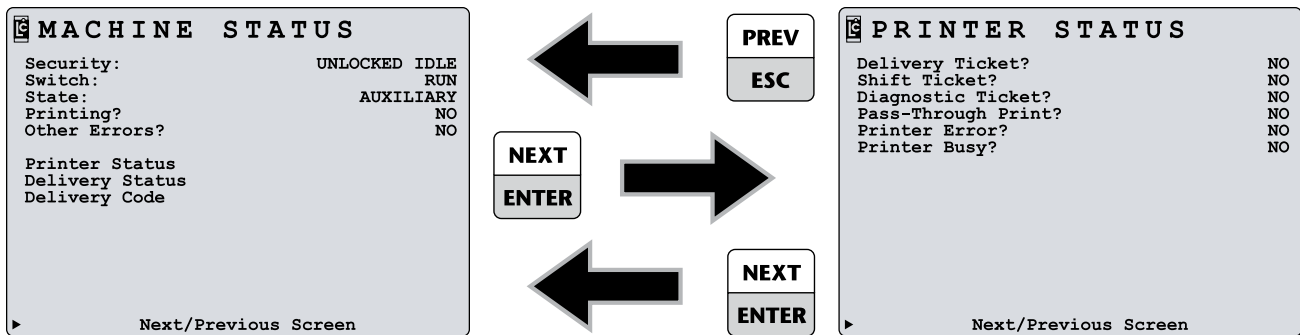

Delivery Status Screen

```

┌ MACHINE STATUS
Security:                UNLOCKED IDLE
Switch:                  RUN
State:                   AUXILIARY
Printing?                NO
Other Errors?           NO

Printer Status
▶ Delivery Status
Delivery Code

Next/Previous Screen
    
```

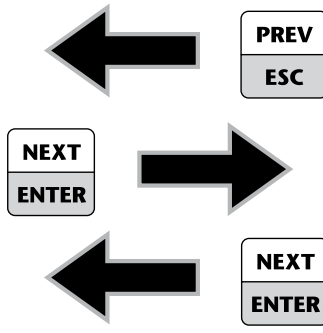

```

┌ DELIVERY STATUS
ROM Check Sum?          NO
Temperature?            NO
Watchdog?               NO
VCF Setup?              NO
VCF Domain?             NO
Meter Calibration?     NO
Pulsar Failure?        NO
Preset Stop?           NO
No-Flow Stop?          NO
Stop/Pause Request?    NO
Print/End Request?     NO
Power Failure?         NO
Preset Error?          NO
RS-232 Lap Pad?        NO
Printer?                YES
Data Access?           NO

▶ Next/Previous Screen
    
```

Delivery Code Screen

```

┌ MACHINE STATUS
Security:                UNLOCKED IDLE
Switch:                  RUN
State:                   AUXILIARY
Printing?                NO
Other Errors?           NO

Printer Status
Delivery Status
▶ Delivery Code

Next/Previous Screen
    
```

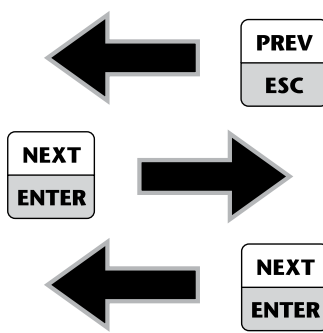

```

┌ DELIVERY CODE
Delivery Ticket?        NO
Shift Ticket?           NO
Flow Active?            NO
Delivery Active?        NO
Gross Preset Active?    NO
Net Preset Active?      NO
Stop/Gross Preset?     NO
Stop/Net Preset?       NO
VCF Active?             NO
S1 Closed?              NO
Delivery Beginning?     NO
New Delivery Queued?    NO
Init Warning?           NO
Config Event?           NO
Calib Event?            NO

▶ Next/Previous Screen
    
```

INTRODUCTION - SECURITY

Levels of Security

Many fields listed in the LCR 600 screens are accessible only while certain security levels are in place. The security levels provide the safeguards essential for Weights & Measures approval, and they give owners and operators a means of restricting drivers to certain functions. There are five levels of security on the LCR 600: Locked, Unlocked, Weights & Measures Calibration, Stop/Pause, and Factory.

LOCKED

An owner/office security setting that limits the access of drivers to a small number of delivery, system, and POS fields.

To lock the LCR 600

1. Select the Security screen from the Configuration Menu.
2. Move the pointer ► to **User Key:** field and press the **ENTER** button.
3. Enter an alphanumeric password in the field edit box and press the **ENTER** button
4. Move the pointer ► to the **security:** field and press the **ENTER** button.
5. Move the pointer ► to **Locked** in the list box and press the **ENTER** button.

UNLOCKED

An owner/office security setting that allows drivers access to a large number delivery, system, and POS fields.

To unlock the LCR 600

1. Select the Security screen from the Configuration Menu.
2. Move the pointer ► to **User Key:** field and press the **ENTER** button.
3. Enter the same alphanumeric password that was entered when the LCR 600 was locked. The value of the **security:** field will change to **UNLOCKED**.

Throughout this manual, the security levels that allow access to a each LCR 600 field is included with the field definition. The abbreviation for each security level is as follows:

- L - Locked
- U - Unlocked
- C - Weights & Measures Calibration
- P - Stop/Pause
- F - Factory

WEIGHTS & MEASURES CALIBRATION

The Weights & Measures Calibration security setting allows access to all fields and functions necessary for Weights & Measures approval and the complete configuration of the LCR 600 for service.

To enter the Weights & Measures Calibration mode

1. Remove the faceplate around the red selector switch. If the LCR 600 was Weights & Measures approved beforehand, you will need to remove the lead seal and wire threaded through the switchplate screws.

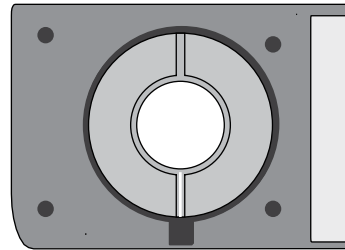

Six O'clock Calibration Position

2. Turn the selector switch to the six o'clock position.

STOP/PAUSE

During deliveries, there are certain fields that may be edited if the selector switch is turned to the STOP (pause) position, for example, preset and miscellaneous charges fields. After editing a field, the delivery can be continued by turning the selector switch back to RUN.

Active Delivery Status

When a delivery is active LCR 600 fields are not editable.

FACTORY

A security setting restricted to LC factory personnel.

SECURITY

Date Format: (LB) C - U

The format in which the date will be displayed and printed.

MM/DD/YY • DD/MM/YY

Date: (FE) C - U

The date according to the selected date format. Enter two digits for the day or month, a backslash, two digits for the month or day, a backslash, and two digits for the year.

Calibration #: *Display only*

The number of times the calibration switch position has been used.

User Key: (FE) C - U - L

The owner/office password. The password is required to unlock the system in order to gain access to secured menu and data entry fields.

Security: (LB) C - U

Locks and unlocks the system. If the system is locked, access is restricted to Gross Preset, Net Preset, Product Code, Product Code, and No-Flow Timer.

LOCKED • UNLOCKED

Factory Key: (FE) C - U - P - L

The pass key required for factory configurations.

SECURITY

Date Format:	MM/DD/YY
Date:	06/24/09
Calibration #:	2
User Key:	
Security:	LOCKED
Factory Key:	

Next/Previous Screen

Field Type

FE - Field Edit Box

LB - List Box

Security Clearance

- L - Locked
- U - Unlocked
- C - Weights & Measures Calibration
- P - Stop/Pause
- F - Factory

INTRODUCTION - POINT-OF-SALE ACTIVATION

Activating the LCR 600 Point-of-sale (POS)

If you ordered the LCR 600 with the POS upgrade, POS was activated in the Liquid Controls factory before shipment. However, the POS upgrade can also be added to a LCR 600 that was shipped without the POS upgrade.

To activate the POS upgrade:

1. Navigate to the Advanced Features screen.
2. Call the Liquid Controls inside sales department at 800-458-5262 and ask for part number SR600POS.
3. Give the representative the values in the **Date:**, **Calibration #:**, and **LCR Serial #:** displayed on the Advanced Features screen. The representative will give you an activation key.
4. Move the pointer ► to **Activate Point-Of-Sale** and enter the activation key.

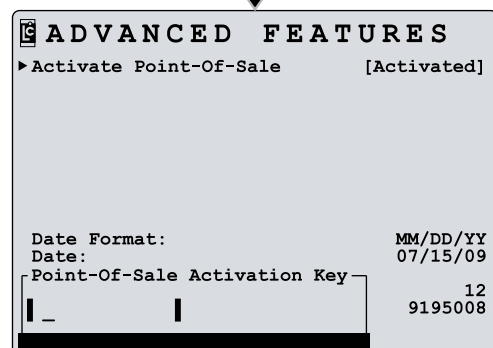
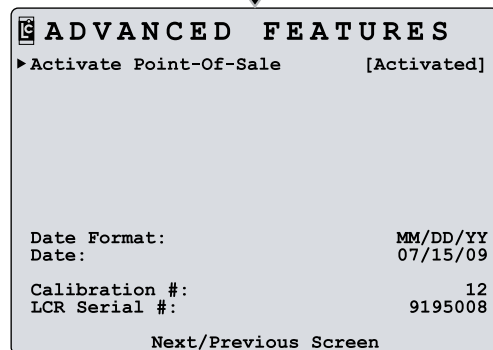
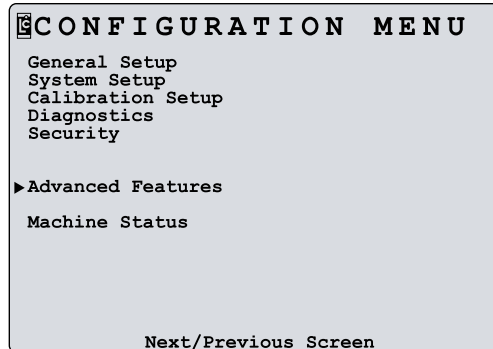



LCR 600 SETUP

LCR 600 Setup Overview

Before using the LCR 600 to deliver fuel, it must be setup to fit its specific application requirements.

A COMPLETE LCR 600 SETUP SHOULD

1. Configure the LCR 600 to all existing input and output components.
2. Calibrate the meter system for Weights and Measures approval.
3. Enter user information and preferences.
4. Enter all data needed to run the LCR 600 POS upgrade (optional).

The simplest and most comprehensive method of accomplishing these four tasks is to go through each field in each setup screen and make the necessary changes. Start with the General Setup and move down the Configuration Menu list through the System Setup, Calibration Setup, and Setup POS screens. The following pages provide an explanation of each field in these screens, calibration instructions, and instructions for setting up the LCR 600 POS.

GENERAL SETUP 1

Unit ID: (FE) C - U

A number used to identify the driver, location, or truck designated to the LCR 600.

Date Format: (LB) C - U

The format in which the date will be displayed and printed.

MM/DD/YY • DD/MM/YY

Date: (FE) C - U

The date in the selected date format. Enter two digits for the day or month, a backslash (or decimal point), two digits for the month or day, a backslash, and two digits for the year.

Time: (FE) C - U

The time of LCR 600's internal clock. The time is kept by the LCR 600 and printed on the delivery tickets. Enter the current hour, minutes, and seconds in military time, for example 13:01:15 for 1:01:15 PM.

Presets Allowed: (LB) C - U - L

Limits or allows preset options in the Delivery Screens.

None disables all presetting

Gross enables only gross presetting

Net enables only net presetting

Both enables gross and net presetting

Sale #: (FE) C

The number of transactions processed by the LCR 600. Any number entered in this field will restart the count and begin at the entered number. 0-999999 range.

Ticket #: (FE) C

The number of tickets printed by the LCR 600, including multiple and duplicate tickets. Any number entered will restart the count and begin at the entered number. 1-999999 range. If a 0 is entered, the ticket # will not print on the delivery ticket and the value will not increment.

Print Gross and Parameter? (LB) C

Determines if the gross volume and compensation parameter—if the product is temperature compensated—is printed on the ticket.

Volume Corrected Message? (LB) C

Determines if the message noting that the delivery volume has been corrected to a base temperature is printed on the ticket, for example "Gallons corrected to 60.0°F"

GENERAL SETUP		1
Unit ID:		A101
Date Format:		MM/DD/YY
Date:		06/24/09
Time:		20:20:57
Presets Allowed:		BOTH
Sale #:		4
Ticket #:		0
Print Gross and Parameter?		YES
Volume Corrected Message?		YES
Pulse Output Edge:		RISING
Pulse Output Freq:		1.00 PER GALLONS
▶ Next/Previous Screen		

Pulse Output Edge: (LB) C

Determines the signal of the calibrated pulse output waveform. Some external components function on rising pulse edges, others on falling pulse edges. Refer to the technical manual of the specific component to determine requirements.

Pulse Output Freq: (FE) C

Determines the frequency of the pulse output per unit of measure sent by the Auxiliary Output 3 on terminal 42 of the J12 terminal block. Common components include external counters and injection systems. The default value is 1.

GENERAL SETUP 2

Ticket Header Text: (FE) C - U (Lines 11 and 12 C only)

Supplies 12 lines where you can enter text for the ticket header. Every delivery ticket printed by the LCR 600 will print this text at the top of every ticket.

Field Type
FE - Field Edit Box
LB - List Box

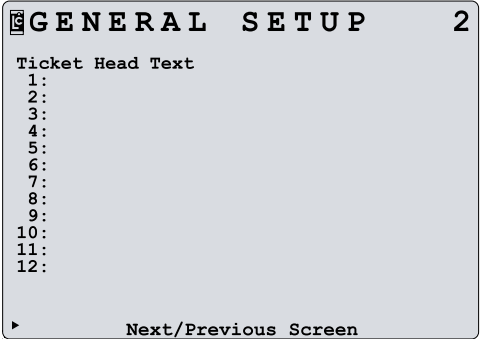

Security Clearance
L - Locked
U - Unlocked
C - Weights & Measures Calibration
P - Stop/Pause
F - Factory

SYSTEM SETUP

SYSTEM SETUP 1

Meter ID: (FE) C

The identification number of the meter the LCR 600 is mounted on. If the LCR 600 is installed in a multiple-meter system, it is important this number be unique. The number is printed on the calibration/diagnostic ticket. LC recommends entering the meter's serial number to ensure identification.

LCP Node Address: (FE) C - U

Node address used by a host application, like the DMS i1000, to communicate with the LCR 600.

Unit of Measure: (LB) C

The unit of flow measurement.

Gallons • Litres • Cubic M • Lbs (pounds) • Kgs • Barrels • Other

Decimal Digit: (LB) C

The decimal place of volume measurements shown on the display and printed tickets.

Hundredths • Tenths • Whole

Residual Processing: (LB) C

The treatment of excess decimal places when displaying and printing volume measurements

Round according to one half of the least significant digit

Truncate disregards the excess digits

Flow Rate Base: (LB) C

The time unit of the measured flow rate.

Per Second • Per Minute • Per Hour

Flow Direction: (LB) C

The direction of flow through the meter. If the LCR 600 is counting in reverse (decreasing numbers), select the opposite Flow Direction.

<- • ->

Printer: (LB) C

The type of printer connected to the LCR 600.

EPSON NewFontB EPSON 200 Roll and EPSON 220 Roll

EPSON NewFontA EPSON TM-T88iii

EPSON OldFontA EPSON 290 Slip and EPSON 295 Slip

EPSON OldFontB EPSON 300 Roll

OKIDATA ML184T OKIDATA ML184T

BLASTER Cognitive Solutions Thermal Printer.

SYSTEM SETUP		1
Meter ID:	A101	
LCP Node Address:	250	
Unit of Measure:	GALLONS	
Decimal Digits:	TENTHS	
Residual Processing:	ROUND	
Flow Rate Base:	PER MINUTE	
Flow Direction:	->	
Printer:	EPSON OldFontA	
Ticket Required?	YES	
dP Shutdown Value:	25.0	
Next/Previous Screen		

Security Clearance

L - Locked
U - Unlocked
C - Weights & Measures Calibration
P - Stop/Pause
F - Factory

Field Type

FE - Field Edit Box
LB - List Box

Ticket Required: (LB) C

Determines if the printer is required to be online and ready to print in order to start a delivery. Most Weights & Measures governed truck applications require a ticket.

Yes deliveries disabled unless a ticket is in the printer, the previous delivery ticket is completed, and the printer is operational.

No deliveries enabled without printer. Tickets will print if the printer is online and has paper.

ΔP Shutdown Value: (FE) C

The differential pressure amount that will shut down an active delivery. This feature pertains to meter systems with a differential pressure transducer and requires a shutdown device. If the value is set to 0, the feature is disabled. 0 to 59.9 range.

SYSTEM SETUP 2

Temperature: (FE) C

The current temperature reading of the RTD temperature probe. To calibrate, simply enter the Weights & Measures thermometer reading. If the LCR 600 does not have an ETVC Kit, this field will read "--".

Temperature Offset: (FE) C

The difference between the official Weights & Measures reading and the LCR 600 RTD reading. The offset is automatically calculated if an entry is made in the previous field. ±0.3°C or ±0.54°F range.

Temperature Unit of Measure: (LB) C

The unit of temperature measured, displayed, and printed.

Deg. C • Deg. F

RTD Slope: F

Factory calibration setting only.

RTD Offset: F

Factory calibration setting only.

Last Calibration Date: Display only

The date and time of the last calibration.

Calibration #: Display only

The number of times the calibration position has been entered. For Weights & Measures use only.

Calibration Event #: Display only

The number of times the calibration has been changed. For Weights & Measures use only. Calibration events include the following: Pulses Per Unit (k-Factor) • Linearization Flow Rate • Linearization Percent Error • Activating Linearization

Configuration Event #: Display only

The number of times the configuration has been changed. For Weights & Measures use only. Configuration events include the following: Sale Number • Gross Totalizer • Net Totalizer • Product Type • Compensation Type • Compensation Parameter • Base Temperature • Auxiliary Multiplier • Auxiliary Unit of Measure • S1 Close • Temperature Offset • Temperature Scale • Quantity Unit of Measure • Decimal Setting • Flow Rate Unit of Measure • Printer Type • Ticket Required Flag • Flow Direction • Meter ID • Ticket Number • Residual Processing • Print Gross and Parameter Flag • Print Volume Corrected Message Flag

Delivery Screen: (FE) C

The format of the active delivery screen, four predefined. The **Detailed POS** is only available LCR 600 POS upgrade. See the pg. 26 for illustrations.

User Defined • Detailed Pump & Print • Volume and Preset • Aviation • Detailed POS

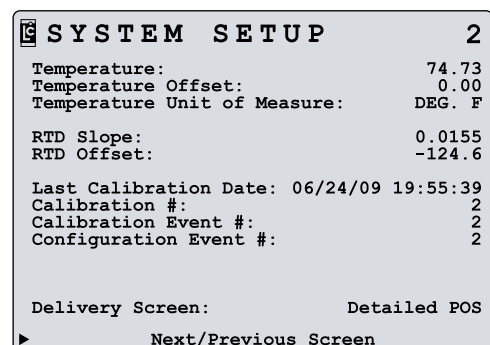

SYSTEM SETUP

Delivery Screens

	116
GALLONS	
Corrected to 60 ° F	
3 PL1 LPG1	LPG
Net Preset:	0.00 GALLONS
Temperature:	72.9 DEG. F
Flow Rate:	0.0 GALLONS PER MINUTE
Net Totalizer:	1538.74 GALLONS
Gross Totalizer:	1601.11 GALLONS
Next/Previous Screen	

DETAILED PUMP & PRINT

	67.2
GALLONS	
510	
GALLONS PER MINUTE	
dP:	18.6
Next/Previous Screen	

AVIATION

	SYSTEM SETUP	2
Temperature:		74.73
Temperature Offset:		0.00
Temperature Unit of Measure:		DEG. F
RTD Slope:		0.0155
RTD Offset:		-124.6
Last Calibration Date: 06/24/09 19:55:39		
Calibration #:		2
Calibration Event #:		2
Delivery Screen		2
User Defined		
Detailed Pump and Print		
▶ Aviation		
Volume and Preset		tailed POS
Detailed POS		

DELIVERY SCREEN LIST BOX

	116
GALLONS	
200	
Remaining Preset	
Product #:	1
Next/Previous Screen	

VOLUME AND PRESET

	34.1
GALLONS	
2 PD1 DIESEL	DISTALLATE
Product #: P4	DIESEL NET 4
Gross Preset:	0.0 GALLONS
Price Preset:	\$ 0.00
Price/Unit:	\$ 3.8900
Total Price Including Tax:	\$ 155.60
Flow Rate:	35.8 GALLONS PER MINUTE
Add Miscellaneous Charges	
Next/Previous Screen	

DETAILED POS

Preparing for Calibration

Before the LCR 600 is put into daily operation, the liquid(s) meant to be measured must be defined and proved. The Calibration Setup screens provide the means to do so. The LCR 600 can hold a total of 16 different calibrations. Calibrations must be defined according to type, and they can be named and coded for easy recognition. If the meter system is equipped with electronic temperature volume compensation, Weights & Measures temperature calibration can be made on Calibration Setup screen 2. The Calibration Setup screens also provide a field to set the dwell flow (**S1 Close:**) and to calculate a second volume in an additional unit of measurement (**Auxiliary Multiplier:** and **Auxiliary Unit of Measure:**). To prove the meter, you will use one of the **BEGIN CALIBRATION DELIVERY** fields and the **Pulses/Unit <k-Factor>** field.

CALIBRATION AND PRODUCT TERMINOLOGY

Previous LectroCount models used the terms Product Code, Product Name, and Product Type for calibration purposes. The LCR 600 has redefined these terms for the POS application and replaced them in the calibration setup with Calibration Code, Calibration Name, and Calibration Type. The definition of "product" has expanded to include not only calibration characteristics but also pricing and tax information.

To setup a calibration for a product (before **proving**):

1. Remove the switchplate and move the selector switch to the calibration position.
2. Navigate to the Calibration Setup 1 screen.
3. Choose a calibration number (1-16) from the **Calibration #:** field.
4. Define the calibration #. Enter the **Calibration Code**, **Calibration Name**, and **Calibration Type**.
5. Navigate to the Calibration Setup 2 screen.
6. If using electronic temperature volume compensation, enter the correct **Compensation Type**. The **Compensation Parameter** and the **Base Temperature** fields will default to the values listed in the table on page 28. Ensure these values are correct for your application. Change them when necessary.
7. Make sure the hose is packed. See *instructions on page 29*.
8. You are now ready to prove the meter system.

Be Careful

Calibration #'s can be overwritten and reproved. Don't accidentally overwrite a Calibration # currently in use.

The Unit of Measurement: field is on the System Setup 1 screen .

```

CALIBRATION SETUP 1
Calibration #: 4           GALLONS
Calibration Code:         P4
Calibration Name:        DIESEL NET
Calibration Type:        DISTALLATE
Linearization Mode:       SETUP
Pulses/Unit <k-Factor>:   20.0000
Prover Quantity:          00 GALLONS
BEGIN CALIBRATION DELIVERY

S1 Close                  2.0 GALLONS

Net Totalizer             0.0 GALLONS
Gross Totalizer          141.7 GALLONS
Next/Previous Screen
    
```

```

CALIBRATION SETUP 2
Calibration #: 2           GALLONS
Compensation Type:        TABLE 24
Compensation Parameter:   0.50000000
Base Temperature:         60.0
Gross Quantity:           11.5 GALLONS
Gross Preset:             0.0 GALLONS
Temperature:              74.7
Net Quantity:             11.2
Auxiliary Multiplier:     4.130
Auxiliary Quantity:       41.3
Auxiliary Unit of Measure: LBS
Next/Previous Screen
    
```

Compensation Types and Parameters

Product	VCF Type	Parameter Coefficient	Range	°Celsius/ °Fahrenheit	Tbase	Tmin	Thold	Tmax
General	Linear	Linear	0 to 0.003	°C	15	-90	N/A	+100
General	Linear	Linear	0 to 0.005	°F	60	-130	N/A	+212
LPG <i>USA</i>	API Table 24	Specific Gravity	0.5 to 0.550	°F	60	-50	-50	+140
LPG <i>Europe & Canada</i>	API Table 54	Density kg/L	0.5 to 0.600	°C	15	-46	-46	+60
Refined Petro- leum Products <i>Europe & Canada</i>	API Table 54B	Density kg/m ³	653.0 to 1075.0	°C	15	-50	-40	+95
Refined Petro- leum Products <i>USA</i>	API Table 6B	API Gravity	0 to 85	°F	60	-50	-40	+200
General	API Table 54C	Coefficient	0.000486 to 0.001674	°C	15	-50	-40	+95
Lube Oil <i>Europe & Canada</i>	API Table 54B	Density kg/m ³	800 to 1164	°C	15	-50	-40	+95
Ammonia <i>Canada</i>	NH ₃	N/A	N/A	°C	15	-30	-30	+40

Single Point or Multi-Point Calibration

The LCR 600 provides two means of calibration, single point or multi-point calibration. A “point” corresponds to a particular flow rate along the meter’s accuracy curve. Single point calibration adjusts one point along the accuracy curve to zero percent error—typically at a flow rate representative of a normal delivery. Multi-point calibration zeroes the percent error at multiple flow rates in order to flatten out the accuracy curve across the meter’s range of flow rates. Multi-point calibration is ideal for applications in which deliveries are made at many different flow rates, while single point calibration is appropriate for applications where a high flow rate is typical for most deliveries.

Single Point and Multi-Point Calibration Accuracy Curves

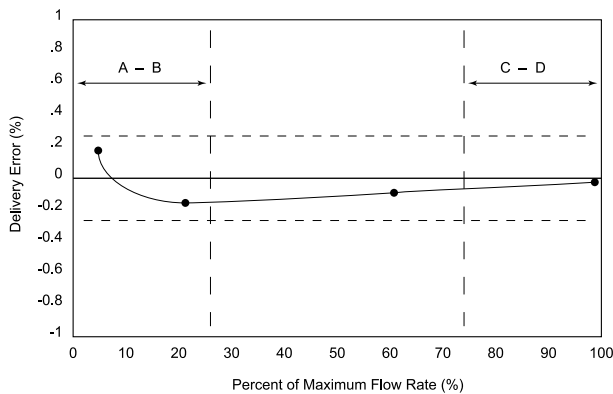

Single Point Calibration Accuracy Curve

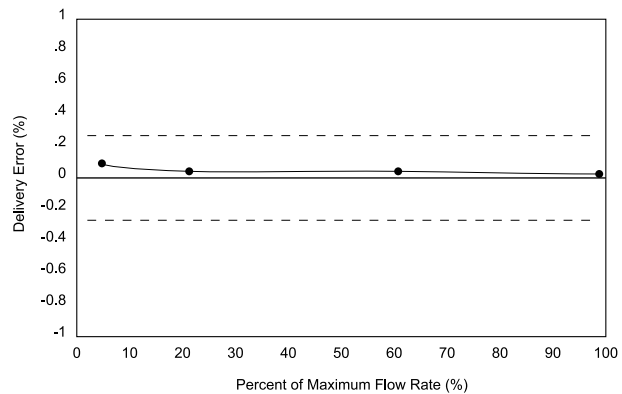

Multi-point Calibration Accuracy Curve

Packing the Hose

If you are proving the meter with a hose and a nozzle, you will want to make sure the hose is packed before beginning the proving delivery. This will ensure the same shut off point at the beginning and end of the delivery.

To pack the hose:

1. Turn the selector switch to RUN—do not open the hose nozzle. The display will reset and the solenoid will open the valve, packing the hose.
2. When the display has stopped incrementing, the hose is packed.
3. Turn the selector switch to STOP. This will de-energize the solenoid, close the valve, and reset the display.
4. Turn the selector switch to the calibration position and follow the proving instructions.

Single Point Calibration Proving

To single point calibrate a product, the LCR 600 must make a delivery into a volumetric prover. The measurement indicated by the volumetric prover is then entered into the LCR 600 to set the k-factor (pulses/unit). The new k-factor establishes the number of pulses the LCR 600's internal pulser registers for each unit of measurement that passes through the meter (for example, 205.8 pulses for every gallon). When proving for use in Weights and Measures applications, a qualified Weights and Measures technician must prove the meter.

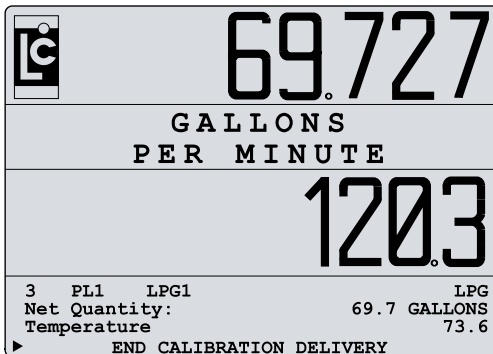

Calibration Delivery Screen

Keep Flow Rates Even
Run the calibration delivery at the same flow rate of a typical delivery.

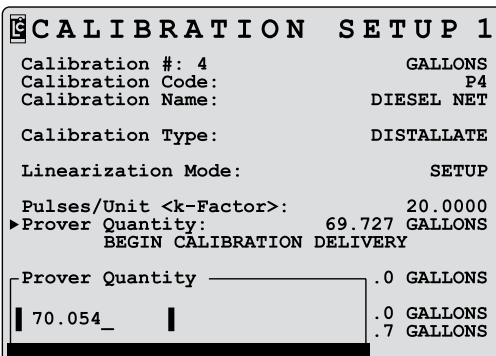

Prover Quantity list box with volumetric prover measurement

To prove a meter system with single point **calibration:**

1. With the selector switch in the calibration position, navigate to the Calibration Setup 1 screen.
2. Select the **Calibration #:** to be proved.
3. Move the pointer ► to **Linearization Mode:** and select **Setup**.
4. Enter a k-Factor that approximates the size of the meter being calibrated. See table on page 30.
5. Move the pointer ► to the **BEGIN CALIBRATION DELIVERY** field.
6. Press the **ENTER** button to begin the calibration delivery into a volumetric prover. A delivery screen will appear that shows the gross volume and flow rate.
7. Move the pointer ► to the **END CALIBRATION DELIVERY** field, at the bottom of the calibration delivery screen, and press **ENTER** to end the delivery.
8. Move the pointer ► to the **Prover Quantity:** and enter the quantity indicated by the volumetric prover. The LCR 600 will automatically adjust the value in the **Pulses/Unit <k-Factor>** field to the correct value.
9. Repeat step 5 through 8. Check the prover volume and the LCR 600 volume. If they are not within tolerance limits, reprove the meter.

Proving can only be done in gross volume.

Approximate k-Factors

VALUES ARE FOR PROVING USE ONLY. NOT TO BE USED AS ACTUAL K-FACTORS.

LC Meter Size	Max Flow Rate/Gallon	Revs / Gallon	Pulses / Gallon	Pulses / Litre
P	60	12.237	4894.8	1293.11
M/MA 5	60	4.079	1631.6	431.04
M/MA 7/10	150	5.555	2222.0	587.01
M/MA 15/25	300	2.058	823.2	217.47
M 30/40	450	0.742	296.8	78.41
M 60/80	800	0.398	159.2	42.06
MS-75	700	0.255	102.0	26.95
MS-120	1200	0.158	63.2	16.70

Multi-Point Calibration Proving

Multi-point calibration improves the overall meter accuracy by flattening out the accuracy curve across flow rates. Although accuracy tends to lessen at lower flow rates, the repeatability of the meter remains consistent. The meter might not be perfectly accurate at low flow rates, but it is inaccurate the same amount each time. Multi-point calibration takes advantage of the steadfast repeatability of a Liquid Controls meter by identifying the amount of inaccuracy and correcting it with a linearizing algorithm during deliveries. In order to apply the linearizing algorithm, the degree of error for points along the accuracy curve must be identified by making a number of deliveries at different flow rates into a volumetric prover. Multi-point calibration is very beneficial for meter systems that experience a wide range of flow rates (for example, trucks that fill tanks of varying sizes) and for meter systems that have recently undergone maintenance or other alterations that could change the accuracy curve itself.

To prove a meter system to a product with multi-point calibration:

1. With the selector switch in the calibration position, navigate to the Calibration Setup 1 screen.
2. Use the instructions on the page 29 to run a single point calibration.
3. Navigate to Calibration Setup 3. Move the pointer ► to **Linearization Mode:** and select **Setup**.
4. Move the pointer ► to the **BEGIN CALIBRATION DELIVERY** field.
5. Press the **ENTER** button to begin the calibration delivery into a volumetric prover. A delivery screen will appear that shows the gross volume and flow rate.
6. To end the delivery, move the pointer ► to the **END CALIBRATION DELIVERY** field at the bottom of the calibration delivery screen.
7. Move the pointer ► to the **Prover Quantity:** and enter the quantity indicated by the volumetric prover.
8. The LCR 600 will automatically display a **Point #:** list box with the numbers 1-10. Select a number.
9. The LCR 600 will then display a **Linearization Flow Rate** field edit box. Enter the flow rate of the proving run. The percent error is calculated automatically.

Multi-Point Calibration Tip

For the first two proving runs, one should be near the maximum flow rate and one near the minimum flow rate of the meter. When choosing flow rates after the initial two proving runs, split the difference until all points are within 0.25% of each other.

Keep Flow Rates Even

Run the first multi-point calibration delivery at the same flow rate used in step 2.

Proving runs are in gross volume only.

Multi-Point Calibration Proving - continued

CALIBRATION SETUP 3			
Calibration #: 3		GALLONS	
► Linearization Mode:		APPLIED	
Linearization Prover Qty:		25.12	
	BEGIN	CALIBRATION	DELIVERY
Point #	Flow Rate	Percent Error	
1:	88.00	-0.030	
2:	11.00	-0.108	
3:	38.00	-0.138	
4:	22.00	-0.171	
5:	30.00	-0.149	
6:	63.00	-0.084	
7:	75.00	-0.055	
8:	0.00	0.000	
9:	0.00	0.000	
10:	0.00	0.000	
Next/Previous Screen			

To prove a meter system to a product with multi-point calibration:

10. Repeat steps 4 through 10 using a new flow rate for the next Point #: until all the points between the lowest flow rate and the maximum flow rate are within 0.25% of each other.
11. Navigate to Calibration Setup 1. Move the pointer ► to Linearization Mode: and select Applied.

The LCR 600 will not allow you to enter the Applied setting of the Linearization Mode: until all adjacent calibration points are within 0.25% of each other.

LCR-600: 60011
Adjacent linearization points out of 0.25% range.

The linearization points on Calibration Setup 3 will automatically sort by flow rate after the Applied setting is selected.

CALIBRATION SETUP

CALIBRATION SETUP 1

Calibration #: (LB) C - U - L

The active calibration of four possible calibrations (16 calibrations possible with POS upgrade). The fields shown on the Calibration Setup 1 screen represent the values of the Calibration # shown. Any edits made to the fields are attributed to the calibration # shown.

Calibration Code: (FE) C - U

The code assigned to the active calibration. This code can be used to correspond with an office code.

Calibration Name: (FE) C - U

The text designation of the active calibration.

Calibration Type: (LB) C

The type of product of the active calibration.

Ammonia • Aviation • Distillate • Gasoline • Methanol • LPG • Lube Oil • blank

Linearization Mode: (LB) C

Disables and enables single and multi-point calibration.

Setup allows the setting of single and multi-point calibration. Disables single and multi-point calibration settings in deliveries.

Applied enables multi-point calibration settings in delivery .

Pulses/Unit <k-Factor>: (FE) C

The number of pulse edges per unit of measure. Applies only to gross volume. This number scales the prover quantity. A unit of 20.0000 is entered on all factory shipments. Changing the k-factor moves the entire meter accuracy curve either up or down.

Prover Quantity: (FE) C

The metered volume of the prover after a calibration delivery. When the prover volume is entered, the LCR 600 adjusts the k-factor to calibrate the pulses/unit. See calibration instructions.

BEGIN CALIBRATION DELIVERY

Starts a calibration delivery.

S1 Close: (FE) C

The point during a preset delivery when the valve switches from full flow to a dwell flow. The value is set according volume units remaining in the delivery. 0 to 500 range.

Net Totalizer: C

Net volume delivered by the LCR 600. In the calibration position, the field can be set to any positive value. The value resets after a clear all.

Gross Totalizer: C

Gross volume delivered by the LCR 600. In the calibration position, the field can be set to any positive value. The value resets after a clear all.

CALIBRATION SETUP 1	
Calibration #: 4	GALLONS
Calibration Code:	P4
Calibration Name:	DIESEL NET
Calibration Type:	DISTALLATE
Linearization Mode:	SETUP
Pulses/Unit <k-Factor>:	20.0000
Prover Quantity:	00 GALLONS
BEGIN CALIBRATION DELIVERY	
S1 Close	2.0 GALLONS
Net Totalizer	0.0 GALLONS
Gross Totalizer	141.7 GALLONS
Next/Previous Screen	

Security Clearance

L - Locked
U - Unlocked
C - Weights & Measures Calibration
P - Stop/Pause
F - Factory

Field Type

FE - Field Edit Box
LB - List Box

CALIBRATION SETUP 2

Calibration #: (LB) C-U-L

The active calibration of four possible calibrations (16 calibrations possible with POS upgrade). The fields shown on the Calibration Setup 1 screen represent the values of the Calibration # shown. Any edits made to the fields are attributed to the Calibration # shown.

Compensation Type: (LB) C

The type of temperature volume compensation applied to the active calibration #. Refer to the Compensation Types and Parameters table on page 28 to find the correct compensation. If NONE is selected, deliveries will be in gross quantities only.

CALIBRATION SETUP 2	
Calibration #: 2	GALLONS
Compensation Type:	TABLE 24
Compensation Parameter:	0.50000000
Base Temperature:	60.0
Gross Quantity:	11.5 GALLONS
Gross Preset:	0.0 GALLONS
Temperature:	74.7
Net Quantity:	11.2
Auxiliary Multiplier:	4.130
Auxiliary Quantity:	41.3
Auxiliary Unit of Measure:	LBS
▶ Next/Previous Screen	

Linear F • Linear C • API Table 24 • API Table 54 • API Table 6B • API Table 54B •
API Table 54C • API Table 54D • NH3 • NONE

Compensation Parameter: (FE) C

The coefficient of expansion, the standard density, API gravity, or the specific gravity applied to the Compensation Type. This field has default values that are set when Compensation Type changes. Ensure the default value is correct. Refer to the Compensation Types and Parameters table on page 30 for ranges.

Base Temperature: (FE) C

The base temperature for temperature compensated deliveries. Although this field is editable for some Compensation Type values, it defaults to 60°F or 15°C according to the selected Compensation Type.

Gross Quantity: *Display only*

The gross volume of the latest calibration delivery.

Gross Preset: (FE) C-U-L-P

The gross preset for the next calibration delivery.

Temperature: *Display only*

The current temperature reading of the RTD temperature probe.

Net Quantity: *Display only*

The net volume of the latest calibration delivery.

Auxiliary Multiplier: (FE) C

The factor used to convert the measured volume of a delivery to an alternate volume or mass unit. If this field is 0, it will not print on the delivery ticket. Users must furnish a conversion factor.

EXAMPLE Auxiliary Multiplier = (SpGr) x (8.345 lbs/gal)
SpGr = specific gravity

Auxiliary Quantity: (FE) C

The alternate volume or mass delivered using the Auxiliary Multiplier.

Auxiliary Unit of Measure: (LB) C

The auxiliary unit of measure printed on the delivery ticket.

Gallons • Litres • Cubic M • LBS • KGS • Barrels • Other

Security Clearance

L - Locked
U - Unlocked
C - Weights & Measures Calibration
P - Stop/Pause
F - Factory

Field Type

FE - Field Edit Box
LB - List Box

CALIBRATION SETUP

CALIBRATION SETUP 3

Calibration #: (LB) C - U - L

The active calibration of four possible calibrations (16 calibrations possible with POS upgrade). The fields shown on the Calibration Setup 1 screen represent the values of the Calibration # shown. Any edits made to the fields are attributed to the Calibration # shown.

Linearization Mode: (LB) C

Disables and enables multi-point calibration.

Setup disables multi-point calibration during normal deliveries.

Used when proving and setting multi-point calibrations.

Applied enables multi-point calibration.

Linearization Prover Qty: (FE) C

The metered volume of the prover after a calibration delivery. When the prover volume is entered, the LCR 600 will prompt you to select a linearization point number and a flow rate. After these values are entered, the LCR 600 will assign the error accordingly. See calibration instructions.

BEGIN CALIBRATION DELIVERY

Starts a calibration delivery.

Point #: (FE) C

The fields under **Point #:** are used to calibrate the meter/register at up to 10 different flow rates for each product type/calibration.

Flow Rate: (FE) C

The flow rate at which the calibration point was measured.

Percent Error: (FE) C

This field contains the percent difference between the register volume and the prover volume.

$$\text{Percent Error} = \frac{[(\text{Prover Qty.} - \text{Meter Qty.}) \div \text{Prover Qty.}] \times 100}{1}$$

CALIBRATION SETUP 3			
Calibration #: 3		GALLONS	
▶ Linearization Mode:		APPLIED	
Linearization Prover Qty:		25.12	
BEGIN CALIBRATION DELIVERY			
Point #	Flow Rate	Percent Error	
1:	88.00	-0.030	
2:	11.00	-0.108	
3:	38.00	-0.138	
4:	22.00	-0.171	
5:	30.00	-0.149	
6:	63.00	-0.084	
7:	75.00	-0.055	
8:	0.00	0.000	
9:	0.00	0.000	
10:	0.00	0.000	
Next/Previous Screen			

Field Type

FE - Field Edit Box

LB - List Box

Security Clearance

L - Locked

U - Unlocked

C - Weights & Measures Calibration

P - Stop/Pause

F - Factory

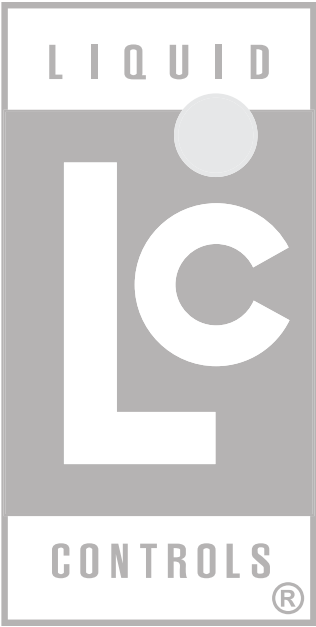

POINT-OF-SALE SETUP

Point-of-Sale (POS) Overview

The LCR 600 POS upgrade enables the LCR 600 to deliver fuel and print delivery tickets with prices, taxes, and discounts. At the delivery site, drivers can add miscellaneous charges to the delivery total, make preset deliveries according to price, and print a priced delivery ticket. To do this, prices, discounts, taxes, and charges need to be loaded into the LCR 600. Once these are loaded, they can be combined into “products”. “Products” are created to match the needs of your customers. Since customers require, for example, different tax structures, a “product” can be created that suits any type of customer you have. The LCR 600 can hold up to 100 “product” configurations.

CALIBRATION AND PRODUCT TERMINOLOGY

*Previous LectroCount models used the terms **Product Code**, **Product Name**, and **Product Type** for calibration purposes. The LCR 600 has redefined these terms for the POS application and replaced them in the calibration setup with **Calibration Code**, **Calibration Name**, and **Calibration Type**. A “product” on the LCR 600 is the combination of a price, a tax, discounts, and a calibration.*

POS SETUP OVERVIEW

The LCR 600 POS was designed to be flexible during setup and easy to use at the delivery site. When a driver reaches a delivery site, he simply selects the preprogrammed “product” that matches that customer’s price, tax, and discount requirements. After delivering the customer’s fuel, the LCR 600 prints a perfectly priced ticket. A copy of the ticket can be given to the customer and another copy can be held for the drivers delivery records.

In the LCR 600 POS, a “product” is the combination of a calibration, a tax structure, a cash discount, a volume discount, and a price. Often, a specific combination of these characteristics will apply to more than one customer; therefore, a driver can use one preprogrammed product for many customers. Before the products can be programmed, four of the five characteristics—calibration, tax category, cash discount, an volume discount—must be programmed. 16 structures can be programmed for each characteristic. Tax structure, cash and volume discounts, and additional charges are programmed in the Setup POS screens. Calibrations are defined in the Calibration Setup screens. The price is entered alphanumerically in the Setup POS screen. LCR 600 POS also provides a Miscellaneous Charges screen where any additional products or services can be loaded into the LCR 600. Drivers can add any of these products or services to the delivery ticket during delivery.



For typical deliveries, drivers will select the correct POS product for the customer, begin the delivery, add any miscellaneous charges, finish the delivery, and give a copy of the priced and taxed ticket to the customer. Certain LCR 600 security settings (at the top of the Setup POS screen) allow drivers to edit the price and discounts of the product; however, the taxing and calibration characteristics of the product can only be changed in the Setup POS screens.

Tax Categories

You can setup 16 different tax categories (or tax structures) in the LCR 600 POS. Each tax category has ten blank lines where you can enter taxes and build a tax structure. The LCR 600 will apply a tax as either a percent of the delivery total, a numerical quantity applied per unit delivered, or a percent tax on other taxes. When a tax category is completed, it can be added to a product in the Setup POS screen, and when that product is selected for a delivery, the LCR 600 will apply the tax category to the delivery total and print a short summary of the taxation on the delivery ticket.

Be careful. Category #s can be overwritten. Don't accidentally overwrite a Category # currently in use.

To setup a tax category:

1. Navigate to the Tax Categories screen in the Setup POS application.
2. Select a category number (1-16) from the **Category #:** field.
3. Enter a name for the category number in the **Name:** field.
4. Move the pointer ► to **A:** field and press enter. The LCR 600 will bring up the **Tax Type** list box (followed by the **Tax Header Text** field edit box and the **Tax Value** field edit box).
5. Select the tax type from the **Tax Type** list box. The LCR 600 will then bring up the **Tax Header Text** field edit box.
- 5a. If **Tax on Tax** is selected from the **Tax Type** list box, a window will appear on the screen asking you to select which taxes should receive the **Tax on Tax**. The letter of the fields receiving the will be displayed in the **Type** column.
6. Enter a name for the tax type in the **Tax Header Text**. The LCR 600 will then bring up the **Tax Value** field edit box.
7. Enter the value of the tax in the **Tax Value** field edit box.
8. Move the pointer ► to **B:** and press enter. Repeat steps 5 to 7.
9. Complete the lettered fields until you have built your entire tax structure.

```

TAX CATEGORIES
Category #:          2
Name:              MAUMEE

Type      Name      Tax
A: PERCENT STATE    5.9000
B: PER UNIT LUCAS CO. 0.0160
C:
► D:
E:
F:
G:
H:
Tax Type
Not Used
Percent
Per Unit
► Tax on Tax
    
```

Tax Type List Box

```

TAX CATEGORIES
Category #:          2
Name:              MAUMEE

Type      Name      Tax
A: PERCENT STATE    5.9000
B: PER UNIT LUCAS CO. 0.0160

Select the taxes that will be taxed
by using the arrow key to move the
cursor to the tax letter.

Press ENTER to select/deselect tax.

      A B C D E F G H I J
      ◆ ◆

Press ESC when done with selections.
    
```

Tax on Tax - Application to Other Taxes

```

TAX CATEGORIES
Category #:          2
Name:              MAUMEE

Type      Name      Tax
A: PERCENT STATE    5.9000
B: PER UNIT LUCAS CO. 0.0160
C:
► D:
E:
F:
G:
H:

Tax Header Text
| MAUMEE CIT |
    
```

Tax Header Text Field Edit Box

```

TAX CATEGORIES
Category #:          2
Name:              MAUMEE

Type      Name      Tax
A: PERCENT STATE    5.9000
B: PER UNIT LUCAS CO. 0.0160
C:
► D:
E:
F:
G:
H:

Tax Value
| 10.00 |
    
```

Tax Value List Box

TAX TYPES

Not Used typically used to erase an existing tax line item.

Percent a percentage, the **Tax Value**, of the delivery subtotal added to the total.

Per Unit a fixed amount, the **Tax Value**, charged per unit of delivered product.

Tax on Tax a percentage, the **Tax Value**, of the delivery subtotal and other selected taxes added to the total.

POINT-OF-SALE SETUP

TAX CATEGORIES

Category #: (LB) C - U - L

The active tax category number. Enter an unused number to create a new tax category or the number of an existing tax category to edit.

Name: (FE) C - U

The name or description of the selected tax category.

Type: (Tax Type) (FE) C - U

The type of tax to apply to the tax value. There are four options:

Not Used typically used to erase an existing tax line item.

Percent a percentage, the **Tax Value**, of the delivery subtotal added to the total.

Per Unit a fixed amount, the **Tax Value**, charged per unit of delivered product.

Tax on Tax a percentage, the **Tax Value**, of the delivery subtotal and other selected taxes added to the total.

Name: (Tax Header Text) (FE) C - U

A name or description of the type of tax.

Tax: (Tax Value) (FE) C - U

The value applied according to the type of tax.

TAX CATEGORIES		
Category #:		2
Name:		MAUMEE
Type	Name	Tax
A: PERCENT	STATE	5.9000
B: PER UNIT	LUCAS CO.	0.0160
C: AB	MAUMEE CITY	10.0000
D: PER UNIT	STATE EXCISE	0.0110
E:		
F:		
G:		
H:		
I:		
J:		

Next/Previous Screen

Security Clearance

- L - Locked
- U - Unlocked
- C - Weights & Measures Calibration
- P - Stop/Pause
- F - Factory

Field Type

- FE - Field Edit Box
- LB - List Box

PURCHASE QTY		171.45	GALLONS
SUBTOTAL	@	2.8990	\$ 411.91
STATE	=	5.9000%	\$ 24.30
LUCAS CO.	=	0.0160	\$ 2.75
CITY	=	10.0000%	\$ 43.90
STATE EXCISE	=	0.0110	\$ 1.89

Tax Section of Delivery Ticket

Cash Discounting

Like the tax categories, the LCR 600 has 16 different cash discounting categories where discounts based on early payment can be outlined. Each cash discounting category has three blank lines where an early payment time period (entered as days from delivery) and a discount (entered as either a percentage of the delivery or a dollar amount per unit) can be entered. When the cash discounting category is completed, it can be added to a product, and when that product is selected for a delivery, the LCR 600 will calculate the discounted price and print them on the delivery ticket.

To setup cash discounting:

1. Navigate to the Cash Discounting screen in the Setup POS application.

2. Select a category number (1-16) from the **Category #:** field.

Be careful. Category #s can be overwritten. Don't accidentally overwrite a Category # currently in use.

3. Name the cash discount in the **Name:** field.

4. Move the pointer ► to the **#1:** field and press enter. The LCR 600 will bring up the **Cash Discount Days** field edit box. Enter the number of days after the delivery the discount will remain valid.

5. The LCR 600 will then bring up the **Percent Cash Discount** field edit box. If you want to offer a discount based on a percentage of the total delivery charge, enter the percentage.

6. The LCR 600 will then bring up the **Per Unit Cash Discount** field edit box. If you want to offer a discount based on a per unit of the total delivery volume, enter the amount.

7. Move the pointer ► to the **#2:** and/or the **#3:** field and press enter. Repeat steps 4 to 6, if you want to offer additional discounts for longer or shorter periods of time.

8. Move the pointer ► to the **Apply Discount** field and select **After Tax** or **Before Tax**.

CASH DISCOUNTING

Category #: (LB) C - U - L
 The active cash discount category number. Enter an unused number to create a new cash discount or the number of an existing cash discount category to edit.

Name: (FE) C - U
 The name or description of the selected cash discount category.

Discount: Display Only
 One of three available levels of cash discounts.

Days: (FE) C - U
 The maximum number of days after delivery in which the percent or per unit discount is valid.

Percent: (FE) C - U
 The discount, if paid within the allotted days, in percentage of the subtotal.

Per Unit: (FE) C - U
 The discount, if paid within the allotted days, in per unit of the volume.

Apply Discount?: (LB) C - U
 Determines when the discount value is applied: **BEFORE TAX** or **AFTER TAX**.

CASH DISCOUNTING

Category #: 2
 Name: 2/10 NET 30

Discount	Days	Percent	Per Unit
#1:	10	2.500	0.0000
#2:	5	5.000	0.0000
#3:	2	7.500	0.0000

▶ Apply Discount? BEFORE TAX

Next/Previous Screen

TOTAL DUE	\$	514.11
IF PAID BY 08/28/09	\$	493.51
IF PAID BY 08/23/09	\$	483.22

Cash Discount Section of Delivery Ticket

Field Type

FE - Field Edit Box

LB - List Box

Security Clearance

L - Locked

U - Unlocked

C - Weights & Measures Calibration

P - Stop/Pause

F - Factory

Volume Discounting

The LCR 600 has 16 different volume discounting categories where discounts based on the delivery volume can be outlined. Each volume discounting category has three blank lines where a volume and a discount (entered as either a percentage of the delivery or a cash amount per unit) can be entered. When the volume discounting category is completed, it can be added to a product, and when that product is selected for a delivery, the LCR 600 will calculate the discounted prices and print them on the delivery ticket.

To setup volume discounting:

1. Navigate to the Volume Discounting screen in the Setup POS application.
2. Select a category number (1-16) from the **Category #:** field.
3. Name the volume discount in the **Name:** field.
4. Move the pointer ▶ to the **#1:** field and press enter. The LCR 600 will bring up the **Discount Volume** field edit box. Enter the delivery volume needed to obtain the discount.
5. The LCR 600 will then bring up the **Percent Volume Discount** field edit box. If you want to offer the discount as a percentage of the total delivery charge, enter the percentage.

6. The LCR 600 will then bring up the **Per Unit Volume Discount** field edit box. If you want to offer the discount as a cash amount per unit of the delivery volume, enter the amount.
7. Move the pointer ▶ to the **#2:** and/or the **#3:** field and press enter. Repeat steps 4 to 6 if you want to offer additional discounts for larger or smaller volumes.

Be careful. Category #s can be overwritten. Don't accidentally overwrite a Category # currently in use.

POINT-OF-SALE SETUP

VOLUME DISCOUNTING

Category #: (LB) C - U - L
The active volume discount category number. Enter an unused number to create a new cash discount or an existing volume discount category number to edit.

Name: (FE) C - U
The name or description of the selected cash discount category.

Discount: Display Only
One of three available levels of volume discounts.

Volume: (FE) C - U
The minimum volume necessary to receive the percent or per unit discount.

Percent: (FE) C - U
The discount, if paid within the allotted days, in percentage of the subtotal.

Per Unit: (FE) C - U
The discount, if paid within the allotted days, in per unit of the volume.

Apply Discount?: (LB) C - U
Determines when the discount value is applied: **BEFORE TAX** or **AFTER TAX**.

```

VOLUME DISCOUNTING
Category #: 1
Name: TEST VOL

Discount Volume Percent Per Unit
#1: 15.0 1.235 0.0000
#2: 35.0 2.999 0.0000
#3: 0.0 0.000 0.1100

Apply Discount? BEFORE TAX

Next/Previous Screen
    
```

Field Type
FE - Field Edit Box
LB - List Box

```

Security Clearance
L - Locked
U - Unlocked
C - Weights & Measures Calibration
P - Stop/Pause
F - Factory
    
```

```

STATE EXCISE : 0.0110 $ 1.89
VOLUME DISCOUNT $ -3.09
-----
    
```

Volume Discount Section of Delivery Ticket

Miscellaneous Charges

The Miscellaneous Charges screen is a list of any additional services or products your company offers. There are 16 possible miscellaneous charges that can be programmed into the LCR 600 POS. Drivers can select the charges from the list during deliveries, and the LCR 600 will add the charge to the delivery total and print each miscellaneous charge onto the delivery ticket.

```

-----
1 FILTER @ 30.0000 $ 30.00
1 LATE DEL@ 75.0000 $ 75.00
TAX $ 8.57
-----
    
```

Miscellaneous Charges Section of Delivery Ticket

To create a miscellaneous charge:

1. Navigate to the Misc Charges screen in the Setup POS application.
2. Move the pointer ► to the a blank field and press **ENTER**. The LCR 600 will bring up the **Misc Charge Name** field edit box. Enter the name of the charge. *Only eight characters are allowed, so you might need to abbreviate.*
3. The LCR 600 will then bring up the **Misc Charge Tax Category** list box. Select the tax category that applies to the charge.
4. The LCR 600 will then bring up the **Misc Charge Unit Price** field edit box. Enter the amount of the product or service.
5. Move the pointer ► to other blank fields and repeat steps 2 to 4 until all possible miscellaneous charges are on the list.

```

DELIVERY SETUP 1
Gross Quantity: 34.1 GALLONS
2 PD1 DIESEL NET DISTALLATE
Product #: PD4 DIESEL NET 4
Gross Preset: 0.0 GALLONS
Price Preset: $ 0.00
Price/Unit: $ 3.8900
Tax Code: DARK CO.
Volume Discount: 1
Cash Discount: EARLY PAYMENT
Auxiliary 1 Output: ON DURING DELIVERY
Auxiliary 2 Output: FLOW DIRECTION
Toggle Flow Rate: 0.0
Preset Type: CLEAR
No-Flow Timer: 180
Add Miscellaneous Charges
Next/Previous Screen
    
```

```

34.1
GALLONS
2 PD1 DIESEL DISTALLATE
Product #: P4 DIESEL NET 4
Gross Preset: 0.0 GALLONS
Price Preset: $ 0.00
Price/Unit: $ 3.8900
Total Price Including Tax: $ 155.60
Flow Rate: 35.8 GALLONS PER MINUTE
Add Miscellaneous Charges
Next/Previous Screen
    
```

Add Miscellaneous Charges at the Bottom of Delivery Setup 1 and the POS Delivery Screen

MISC CHARGES

Name: (FE) C - U

The name or description of the selected cash discount category.

Tax Category: (LB) C - U

The tax category applied to the miscellaneous charge. Choices include tax categories 1 through 16, no tax, same tax as product.

1 through 16 • None • Same as Product

Unit Price: (FE) C - U

The price per unit of the miscellaneous charge.

MISC CHARGES		
#:	Name	Unit Price
1:	FILTER	30.0000
2:		
3:		
4:		
5:		
6:		
7:		
8:		
9:		
10:		
11:		
12:		
13:		
14:		
15:		
16:		

Next/Previous Screen

Setup POS (Creating Products)

After the tax structures and discounts are entered, you can begin creating products. A product is a unique combination of a calibration, a tax structure, a volume discount, a cash discount, and a price. On the setup POS screen, under **PRODUCT SETUP**, the fields below the double line allow you to name the product and assign a calibration a tax structure, discounts, and a price. The LCR 600 provides for 100 different products. All 100 products are all available for selection in the delivery screens.

To create a product:

1. Move the pointer ► to the **Product #:** field and press **ENTER**. Enter a number between 1-100. Make sure the number has not been used for a previous product.
2. Move the pointer ► to the **Code:** field and press **ENTER**. Enter a code unique to this product.
3. Move the pointer ► to the **Name:** field and press **ENTER**. Enter a name unique to the product.
4. Move the pointer ► to the **Calibration #:** field and press **ENTER**. Enter the number of the calibration used to prove the product.
5. Move the pointer ► to the **Tax Category:** field and press **ENTER**. Select one of the preset tax categories for the product.
6. Move the pointer ► to the **Cash Discount:** field and press **ENTER**. Select one of the preset cash discounts for the product.
7. Move the pointer ► to the **Volume Discount:** field and press **ENTER**. Select one of the preset volume discounts for the product.
8. Move the pointer ► to the **Price:** field and press **ENTER**. Enter the price of the product.

Be careful. Product #s can be overwritten. Don't accidentally overwrite a Product # currently in use.

Code #s are often the same as codes employed by company's office records.

SETUP POS	
SETTINGS FOR ALL PRODUCTS	
Lock Discount Categories?	YES
Lock Price?	NO
Price Change Is New Default?	NO
Allow Delivery Price Change?	YES

PRODUCT SETUP	
Product #:	11
Code:	M1
Name:	MAUMEE
Callibration #:	GASOLINE 1
Tax Category:	MAUMEE 2

Cash Discount:	16
Volume Discount:	STATIONS 1
Price:	\$ 2.3990

Next/Previous Screen

No Discounts?

If you don't want to apply a cash discount, volume discount or a tax structures to a product, select a number that has not been programmed with a discount or a tax. See Cash Discounting on page 44.

POINT-OF-SALE SETUP

Setup POS (Creating Products)

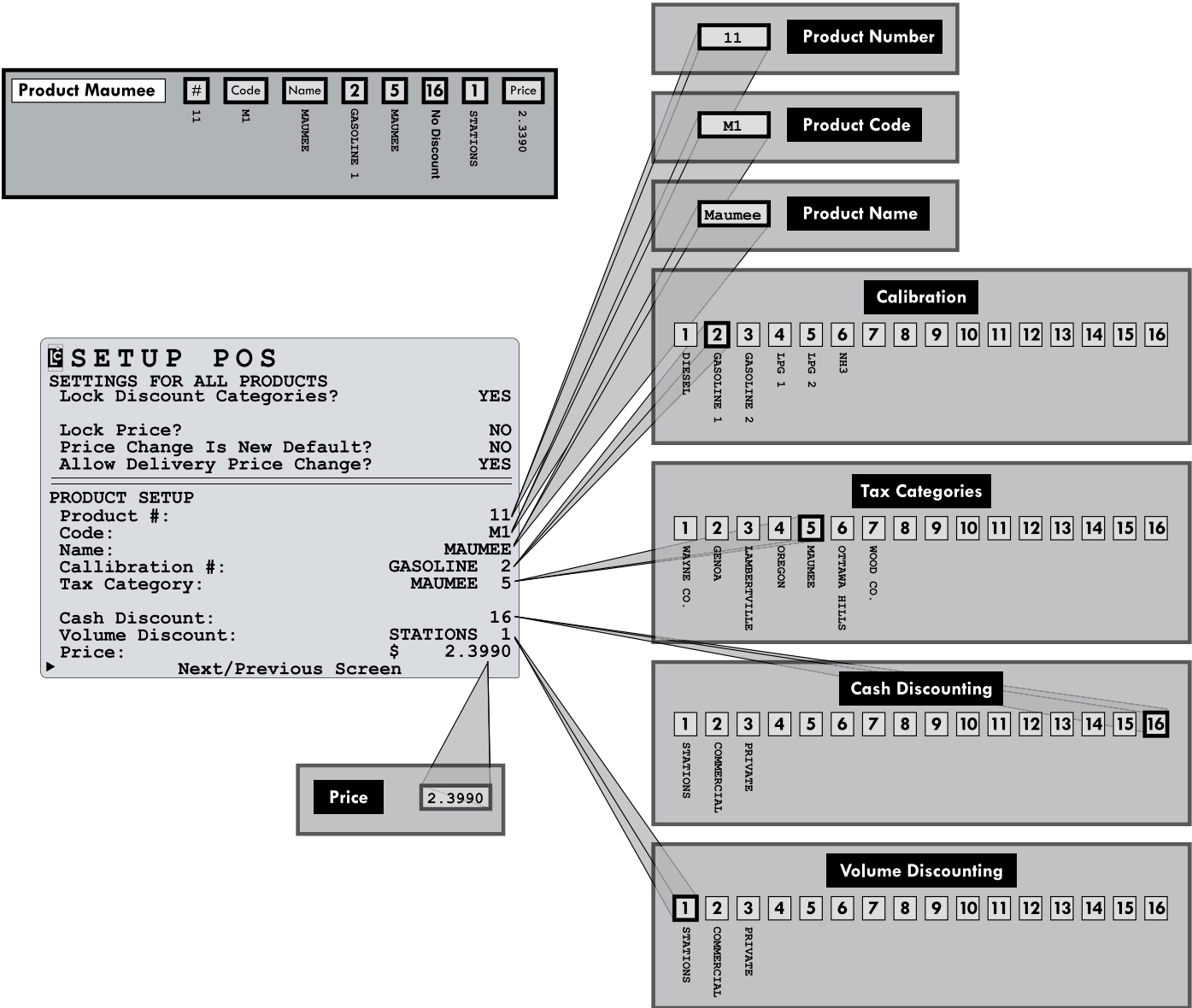

SETUP POS

Lock Discount Categories?: (LB) C - U

Allows or prevents access to the **Volume Discount:** and **Tax Discount:** fields in the POS Delivery Setup 1 screen. If **NO** is selected, the fields default to the values assigned to the product in Setup POS.

Lock Price?: (LB) C - U

Allows or prevents access to the **Price:** field in the POS Delivery Setup 1 screen. If **NO** is selected, the field defaults to the value assigned to the product in Setup POS.

Price Change Is New Default?: (LB) C - U

If **YES** is selected, any price change in the POS Delivery Setup 1 screen will become the default price for all subsequent deliveries. If **NO** is selected, the default price will revert to the value assigned in Setup POS. The **Lock Price?:** setting must be **NO** to activate this setting.

Allow Delivery Price Change?: (LB) C

Allows or prevents a price change while a delivery is active. If **YES** is selected, operators can change the price by turning the selector switch to **STOP** and changing the value in the **Price:** field. This is not allowed in most regions. Consult your local authorities for regulations.

Product #: (FE) C - U - L

The active product number. Enter an unused number to create a new product or an existing product number to edit.

Code: (FE) C - U

The code of the active product number.

Name: (FE) C - U

The name of the active product number.

Calibration #: (LB) C - U

The calibration selected for the active product number.

Tax Category: (LB) C - U

The tax category selected for the active product number.

Cash Discount: (LB) C - U

The cash discount selected for the active product number.

Volume Discount: (LB) C - U

The volume discount selected for the active product number.

Price: (FE) C - U

The price for the active product number.

SETUP POS	
SETTINGS FOR ALL PRODUCTS	
Lock Discount Categories?	YES
Lock Price?	NO
Price Change Is New Default?	NO
Allow Delivery Price Change?	YES
PRODUCT SETUP	
Product #:	11
Code:	M1
Name:	MAUMEE
Callibration #:	GASOLINE 1
Tax Category:	MAUMEE 2
Cash Discount:	16
Volume Discount:	STATIONS 1
Price:	\$ 2.3990
Next/Previous Screen	

Security Clearance

- L - Locked
- U - Unlocked
- C - Weights & Measures Calibration
- P - Stop/Pause
- F - Factory

Field Type

- FE - Field Edit Box**
- LB - List Box**

OPERATION - OVERVIEW/MAKING A DELIVERY

Operation Overview

After setting up the LCR 600 to your specifications, the selector switch faceplate must be fastened and sealed before the LCR 600 is ready for everyday use. While the faceplate is on, the calibration position is not accessible. Still, the LCR 600 can perform all necessary delivery functions including: beginning deliveries, pausing deliveries, ending and printing delivery tickets, setting and making preset deliveries, printing duplicate tickets, printing diagnostic tickets, ending shifts, and printing shift tickets.

Making a Delivery

Making a delivery with the LCR 600 is a simple matter of turning the selector switch to RUN, taking the nozzle to the fueling point, and filling the tank. When the selector switch is turned to RUN, the LCR 600 opens the control valve, product flows through the meter (if the system pump is on), and the LCR 600 displays the delivery volume as it increases. When the delivery is completed, turn the switch to PRINT to print the delivery ticket and close the control valve. If you have an Epson slip printer, make sure the printer has a new delivery ticket loaded in the printer for each delivery. Epson roll printers do not require paper replacement until the paper roll runs out.

The LCR 600 will not begin a delivery without a ticket engaged in the slip printer.

To make a delivery with an Epson slip printer:

1. Press RELEASE on the printer. Insert a blank delivery ticket.
2. Press FORWARD on the printer to engage the ticket.
3. Turn the LCR 600 selector switch to RUN.
4. Take the nozzle to the fueling point and fill the tank.
5. Turn the LCR 600 selector switch to PRINT to print a delivery ticket.
6. When the ticket finishes printing, press RELEASE on the printer. Remove the ticket.
7. Insert a blank delivery ticket and press FORWARD on the printer to engage the new ticket

To make a delivery with an Epson roll printer:

1. Check for paper in the roll printer.
2. Turn the LCR 600 selector switch to RUN.
4. Take the nozzle to the fueling point and fill the tank.
5. Turn the LCR 600 selector switch to PRINT to print a record of the delivery.

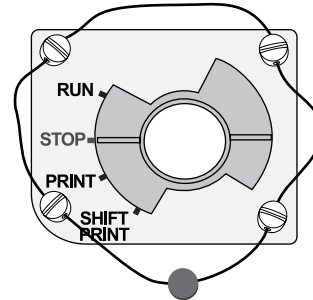

POSITIONS ON THE SELECTOR SWITCH

RUN - opens the control valve to begin a delivery

STOP - closes the control valve to pause a delivery

PRINT - ends a delivery and prints a delivery ticket

SHIFT PRINT - ends a shift, prints a shift ticket, and resets shift data in the LCR 600

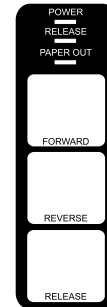

SLIP PRINTER BUTTONS AND INDICATOR LIGHTS

POWER light - light indicates power is on

RELEASE light - light indicates ticket can be removed

PAPER OUT light - light indicates no paper in printer

FORWARD button - moves paper forward

REVERSE button - moves paper backward

RELEASE button - release ticket for removal



ROLL PRINTER BUTTONS AND INDICATOR LIGHTS

ERROR light - light indicates printer unable to print (see printer manual)

POWER light - light indicates power is on

PAPER OUT light - light indicates no paper in printer

FEED button - moves paper forward

Delivery Screens

After switching the selector switch to RUN, one of four delivery screens will appear on the screen—Detailed Pump & Print, Volume and Preset, Aviation, and POS Delivery. Most fields in the delivery screens are display only. Without the LCR 600 POS upgrade, the only editable fields are the preset fields. With the POS upgrade, the POS Delivery screen contains editable fields that effect the pricing configuration printed on the delivery ticket. To change the delivery screen, use the **Delivery Screen** field on the System Setup 2 screen.

	11.6
GALLONS	
Corrected to 60 ° F	
3 PL1 LPG1	LPG
Net Preset:	0.00 GALLONS
Temperature:	72.9 DEG. F
Flow Rate:	0.0 GALLONS PER MINUTE
Net Totalizer:	1538.74 GALLONS
Gross Totalizer:	1601.11 GALLONS
◀ Next/Previous Screen ▶	

DETAILED PUMP & PRINT

DETAILED PUMP & PRINT

Calibration details - Display Only

The calibration number, calibration code, calibration name, and calibration type of the active calibration

Net Preset: (FE) U - L - P

Preset value according to net volume. *This field will be named Gross Preset when the active calibration is not temperature compensated.*

Temperature: Display only

The current temperature reading of the RTD temperature probe.

Flow Rate: Display Only

The current flow rate through the meter.

Net Totalizer: Display only

Net volume delivered by the LCR 600. In the calibration position, the field can be set to any positive value. The value resets after a clear all. *This field only appears when the calibration is temperature compensated.*

Gross Totalizer: Display only

Gross volume delivered by the LCR 600. In the calibration position, the field can be set to any positive value. The value resets after a clear all.

	11.6
GALLONS	
200	
Remaining Preset	
Product #:	1
◀ Next/Previous Screen ▶	

VOLUME AND PRESET

VOLUME AND PRESET

Product #: Display only

The active product number.

	67.2
GALLONS	
510	
GALLONS PER MINUTE	
dP:	18.6
◀ Next/Previous Screen ▶	

AVIATION

AVIATION

ΔP: Display only

The current differential pressure. Field only shown if the LCR 600 is connected to a ΔP transducer.

OPERATION - DELIVERY SCREENS

Delivery Screens (continued)

POS DELIVERY

Product #: (FE) C - U - L

The active product number. Select the field to change the product for the next delivery.

Gross Preset: (FE) U - L - P

Preset value according to gross volume. *This field will be Net Preset when the active product is temperature compensated.* See preset directions on pg. 46.

Price Preset: (FE) U - L - P

Preset value according to gross volume. See preset directions below.

Total Price Excluding Tax: Display Only

The total price according to the current volume and price per unit

Flow Rate: Display Only

The current flow rate through the meter.

Add Miscellaneous Charges U - L - P

Opens the Add Miscellaneous Charges screen where you can select products and services and add their price to the total.

To add a miscellaneous charge to a delivery:

1. Turn the selector switch to RUN to start a delivery.
2. Turn the selector switch to STOP to pause the delivery.
3. Move the pointer ► to the **Add Miscellaneous Charges** field and press **ENTER**.
4. Move the pointer ► to a charge, press **ENTER**, enter an amount into the filed box, and press **ENTER**.
5. Move the pointer ► to **Next/Previous Screen** and press **ENTER**.
6. Turn the selector switch to RUN to resume the delivery.

Preset Deliveries

A preset delivery automatically closes the control valve and ends a delivery when the LCR 600 reaches a predetermined volume. Preset volumes can be entered before in the **Gross Preset**, **Net Preset**, or **Price Preset** (POS upgrade only) fields. When the selector switch is turned to RUN and the nozzle opened, the LCR 600 will automatically end the delivery volume reaches the preset volume.

The location of preset fields varies according to the type delivery screen activated. There are preset fields on the Detailed Pump & Print delivery screen, Detailed POS delivery screen, the Delivery Setup 1 screen, and the Delivery Setup 1 (POS).

LC 34.1
GALLONS

2	PD1	DIESEL	DISTALLATE
Product #:	P4	DIESEL NET	4
Gross Preset:		0.0	GALLONS
Price Preset:		\$	0.00
Price/Unit:		\$	3.8900
Total Price Including Tax:		\$	155.60
Flow Rate:		35.8 GALLONS PER MINUTE	
Add Miscellaneous Charges			
Next/Previous Screen			

POS Delivery Screen

LC ADD MISC CHARGES

Qty	Name	Unit Price	Charge
0	FILTER	\$ 30.0000	\$ 0.00
0	LATE DEL	\$ 75.0000	\$ 0.00
0	WILLCALL	\$ 75.0000	\$ 0.00
0	MIN VOL	\$ 75.0000	\$ 0.00
2	ADDITIVE	\$ 22.5000	\$ 45.00
0	BRNRCHK	\$ 40.0000	\$ 0.00

Next/Previous Screen

Add Miscellaneous Charges Screen

LC 11.6
GALLONS
Corrected to 60 ° F

3	PD1	LPG1	LPG
Net Preset:		0.00	GALLONS
Temperature:		72.9	DEG. F
Flow Rate:		0.0	GALLONS PER MINUTE
Net Totalizer:		1538.74	GALLONS
Gross Totalizer:		1601.11	GALLONS
Next/Previous Screen			

Detailed Pump & Print Preset Field

LC 34.1
GALLONS

2	PD1	DIESEL	DISTALLATE
Product #:	P4	DIESEL NET	4
Gross Preset:		0.0	GALLONS
Price Preset:		\$	0.00
Price/Unit:		\$	3.8900
Total Price Including Tax:		\$	155.60
Flow Rate:		35.8 GALLONS PER MINUTE	
Add Miscellaneous Charges			
Next/Previous Screen			

POS Delivery Preset Fields

```

DELIVERY SETUP 1
1 PT1 GAS 91          GASOLINE
Calibration Code:    PT1
Calibration Name:    GAS 91

Preset Type:        CLEAR
Net Preset:         0.0 GALLONS
Gross Preset:       20.0 GALLONS

Price/Unit:         2.7790
Tax/Unit:           0.0000
Percent Tax:        6.75
Total Price:        55.48

No-Flow Timer       180
Net Quantity:       0.0 GALLONS
Gross Quantity:     18.7 GALLONS
Next/Previous Screen
    
```

Delivery Setup 1 Preset Fields

```

DELIVERY SETUP 1
Gross Quantity:     34.1 GALLONS
2 PD1 DIESEL NET    DISTALLATE
Product #:          PD4    DIESEL NET 4
Gross Preset:       0.0 GALLONS
Price Preset:       $ 0.00
Price/Unit:         $ 3.8900
Tax Code:           DARK CO.
Volume Discount:    1
Cash Discount:      EARLY PAYMENT

Auxiliary 1 Output: ON DURING DELIVERY
Auxiliary 2 Output: FLOW DIRECTION
Toggle Flow Rate:  0.0
Preset Type:        CLEAR
No Flow Timer:     180
Add Miscellaneous Charges
Next/Previous Screen
    
```

Delivery Setup 1 (POS) Preset Fields

What's in a Price Preset?

LCR 600 price presets add taxes into the total preset value but it does not account for discounts or miscellaneous charges. The LCR 600 will deliver the volume as close to the price as possible without exceeding the preset price

GROSS, NET, AND PRICE PRESETS

The LCR 600 will deliver gross and net presets. LCR 600s with the POS upgrade will deliver price presets as well. If the active calibration is not temperature compensated, the LCR 600 will only deliver gross volume presets. If the active calibration is temperature compensated, both gross and net presets can be delivered (depending on system settings).

PRESET TYPES

The LCR 600 provides four settings for preset deliveries. The **Preset Type** field is on the Delivery Setup 1 screen for the base and POS LCR 600 software.

Clear resets the preset values to 0 after the current delivery is ended.

Retain maintains the preset values to be used again on the next delivery.

Multiple allows more than one preset to be run before a delivery ticket is printed. Delivery ticket printed with PRINT command.

Inventory maintains the remaining preset amount between deliveries. *This option is typically used to indicate the remaining volume in the vehicle tank.*

S1 CLOSE

The **s1 close** field sets the duration, in volume, of the dwell flow before the end of a preset delivery. For example, if the S1 close value is two gallons and the preset volume is 20 gallons, the dwell flow will begin 18 gallons into the delivery. A dwell flow slows the flow rate before the end of a delivery to lessen the hydraulic shock incurred upon shut off. The **s1 close** field is on the Calibration Setup 1 screen.

Packing the Hose

To comply with Weights & Measures requirements, it is necessary to start and stop each delivery with a fully packed hose. Normally, this will be the case. However, there are times where the hose is not fully packed (e. g., after a preset delivery). In those instances, the hose must be packed and the register zeroed before making the next delivery.

To pack the hose:

1. Turn the selector switch to RUN—do not open the hose nozzle. The display will reset and the solenoid will open the valve, packing the hose.
2. When the display has stopped incrementing, the hose is packed.
3. Turn the selector switch to STOP. This will de-energize the solenoid and close the valve.
4. Turn the selector switch back to RUN. The display will reset to zero, and the solenoid will energize again and open the valve. *If more than one gallon or five litres register on the LCR 600, the display will not zero out.*
5. Open the hose nozzle and begin the delivery.

This procedure will not work for an empty or dry hose. If more than 1 gallon or 5 litres of liquid is required to pack the hose, a delivery ticket must be printed.

The selector switch can only be turned to STOP one time per delivery, at the start of the delivery, to pack the hose.

OPERATION - TICKETS

Duplicate Delivery Tickets

To print a duplicate delivery ticket:

1. Press RELEASE on the printer. Insert a blank delivery ticket.
2. Press FORWARD on the printer to engage the ticket.
3. Turn the LCR 600 selector switch to PRINT and then to STOP.
4. When the ticket finishes printing, press RELEASE on the printer. Remove the ticket.
5. Insert a blank delivery ticket and press FORWARD on the printer to engage the new ticket

```
TICKET NUMBER                23
HE'S OILS
5531 VAN DRIVE
SKOKIE, IL 60454
START          07/10/09 14:44:02
FINISH        07/10/09 14:44:35

START COUNT          0.0 GALLONS
END GROSS COUNT     11.0 GALLONS
END NET COUNT       10.7 GALLONS
GROSS DELIVERY      11.0 GALLONS
NET DELIVERY        10.7 GALLONS
PL1 LPG1            LPG      3
TABLE 24 SG 60/60    0.5
SALE NUMBER          16
METER NUMBER        S1900

-----
PURCHASE QTY        10.7 GALLONS
SUBTOTAL @ 3.3390   $ 35.78
STATE : 4.0000%    $  1.43
CO.   : 15.0000%   $  5.57
-----
TOTAL DUE           $ 42.78

IF PAID BY 07/15/2011 $ 40.60

** DUPLICATE TICKET **
```

Duplicate Delivery Ticket

Shift Tickets

To print a shift ticket:

1. Press RELEASE on the printer. Insert a blank delivery ticket.
2. Press FORWARD on the printer to engage the ticket.
3. Turn the LCR 600 selector switch to SHIFT PRINT.
4. When the ticket finishes printing, press RELEASE on the printer. Remove the ticket.
5. Insert a blank delivery ticket and press FORWARD on the printer to engage the new ticket

```
SHIFT START          07/14/09 10:44:02
SHIFT FINISH        07/14/09 16:11:35
UNIT ID

CALIBRATION NUMBER 3      LPG
SHIFT NET            399.2 GALLONS
SHIFT GROSS          403.6 GALLONS
TOTAL NET            11695.3 GALLONS
TOTAL GROSS          11774.3 GALLONS
DELIVERIES          3
```

Shift Ticket

*Shift tickets can run over the length of a standard slip printer ticket especially if more than one product was delivered during the shift. Two tickets may be required. When the printer stops printing, replace the ticket and press **ENTER** on the LCR 600.*

DELIVERY SETUP 1

Product & Calibration details (FE) U - L

C1 PT1 GAS 91 Gasoline

The calibration number, calibration code, calibration name and calibration type of the active calibration

Calibration Code: (FE) U - L

The code assigned to the active calibration. Often, this code corresponds with an office code.

Calibration Name: (FE) U - L

The text designation of the active calibration.

Preset Type: (LB) U

Provides four options for handling preset deliveries.

Clear resets the preset values to 0 after the current delivery is ended.

Retain maintains the preset values to be used again on the next delivery.

Multiple allows more than one preset to be run before a delivery ticket is printed. Delivery ticket printed with PRINT command.

Inventory maintains the remaining preset amount between deliveries. Typically used to indicate the remaining volume in the vehicle tank.

Net Preset: (FE) U - L - P

Preset value according to net volume.

Gross Preset: (FE) U - L - P

Preset value according to gross volume.

Price/Unit: (FE) U - L - P

The active price per unit of measure.

Tax/Unit: (FE) U - L

The active tax per unit of measure.

Percent Tax: (FE) U - L

The percentage of the total price added to the total price as a tax.

Total Price: *Display Only*

The total price of the active delivery.

No-Flow Timer: (FE) U - L

The amount of time until the LCR 600 ends a delivery and prints a ticket after it senses that no product is flowing through the meter. The time can be set from 0 to 3600 seconds. If the time is set as 0, the feature is deactivated and the message "Multiple Deliveries at One Site" will be printed on the delivery ticket. If the value is greater than 180, the message "Multiple Deliveries at One Site" will be printed on the delivery ticket. The No-Flow Timer protects product from being delivered to unauthorized locations sometimes referred to as "riding the ticket". Increasing the value allow fuelers to deliver fuel to more than one tank (or fueling point) at a single site and print one ticket that includes every tank at that site. The No-Flow Timer is not active in the calibration mode.

Net Quantity: *Display Only*

The net quantity of the active delivery.

Gross Quantity: *Display Only*

The gross quantity of the active delivery.

DELIVERY SETUP		1
1	PT1 GAS 91	GASOLINE
	Calibration Code:	PT1
	Calibration Name:	GAS 91
	Preset Type:	CLEAR
	Net Preset:	0.0 GALLONS
	Gross Preset:	20.0 GALLONS
	Price/Unit:	2.7790
	Tax/Unit:	0.0000
	Percent Tax:	6.75
	Total Price:	55.48
	No-Flow Timer	180
	Net Quantity:	0.0 GALLONS
	Gross Quantity:	18.7 GALLONS
	Next/Previous Screen	

Field Type

FE - Field Edit Box

LB - List Box

Security Clearance

L - Locked

U - Unlocked

C - Weights & Measures Calibration

P - Stop/Pause

F - Factory

OPERATION - DELIVERY SETUP

DELIVERY SETUP 2

Calibration details - *Display Only*

The calibration number, calibration code, calibration name and calibration type of the active calibration

Auxiliary 1 Output: (LB) U

Determines when to activate the Auxiliary 1 component. Common Auxiliary 1 components are pump controls, additive injectors, and alarms. The value of this field is unique to each product. The options include:

- Off
- On
- On During Delivery

Monitor Flow Rate activates Auxiliary 1 at the beginning of the delivery and deactivates at 40 units/time flowrate

Toggle Flow Rate activates Auxiliary 1 at flowrate designated in the **Toggle Flow Rate** field

Auxiliary 2 Output: (LB) U

Determines when to activate the Auxiliary 2 component. Common Auxiliary 2 components are pump controls, additive injectors, and alarms. The value of this field is unique to each product. The options include:

- off
- On
- On During Delivery

Flow Direction activates Auxiliary 2 according to the Flow Direction field on the System Setup 1 screen

Toggle Flow Rate: (FE) U

The flow rate value at which Auxiliary 1 activates in the **Toggle Flow Rate** mode. Auxiliary 1 remains activated above the set flow rate value and deactivates when the flow rate falls below the value. A common output is an air operated valve (AOV) on the pump. When the flow rate value is attained, the AOV is activated switching the pump from low bypass pressure mode to full flow fuel mode (high bypass pressure). When the flow rate falls below the set value, the AOV deactivates and the pump returns to low flow. Another possible output is the engine throttle—to increase and decrease the RPM of the pump shaft. In applications such as these, the flow rate value in this field should be below the low flow rate with a fully open nozzle or the output will never turn on. Another application of this field is to set the value as a maximum flow rate at which a valve should be closed. On fuel delivery trucks, flow valves often activate an internal switch at approximately 18 GPM (68 LPM). The value of this field is unique to each product.

Ticket Header Text: (FE) U (*Lines 11 and 12 are Weights & Measures protected*)

Supplies 10 lines where you can enter text for the ticket header. Every delivery ticket printed by the LCR 600 will print this text at the top of every ticket. Lines 11 and 12 must be edited in General Setup 2 while in the calibration position.

DELIVERY SETUP 3

Calibration details - *Display Only*

The calibration number, calibration code, calibration name and calibration type of the active calibration.

Shift Start: *Display Only*

Date and time when the active shift started.

Deliveries: *Display Only*

Number of deliveries for the active shift.

Shift Net: *Display Only*

Net volume delivered during the active shift.

Shift Gross: *Display Only*

Gross volume delivered during the active shift.

```
DELIVERY SETUP 2
1 PT1 GAS 91 GASOLINE
Auxiliary 1 Output: ON DURING DELIVERY
Auxiliary 2 Output: FLOW DIRECTION
Toggle Flow Rate: 0.0

Ticket Header Text
1: MURPHY TANK
2: 45557 HARWICK HIWAY
3: CONRAD, MONTANA 59425
4:
5:
6:
7:
8:
9:
10:
Next/Previous Screen
```

Field Type

FE - Field Edit Box
LB - List Box

```
DELIVERY SETUP 3
1 PT1 GAS 91 GASOLINE
Shift Start: 06/29/09 17:36:57
Deliveries: 4
Shift Net: 0.0 GALLONS
Shift Gross: 62.8 GALLONS
Clear Shift? NO

Net Totalizer:
Gross Totalizer: 141.77 GALLONS
Next/Previous Screen
```

DELIVERY SETUP 3 (continued)

Clear Shift: (LB) U
Resets active shift data.

Net Totalizer: Display Only
Net volume delivered by the LCR 600. Can only be reset in calibration position or with a clear all.

Gross Quantity: Display Only
Gross volume delivered by the LCR 600. Can only be reset in calibration position or with a clear all.

DELIVERY SETUP 1 (POS)

Delivery Setup screen for LCR 600's with the POS upgrade

Gross Quantity: Display Only
The quantity according to gross volume. *This field will be Net Quantity when the active product is temperature compensated.* See preset directions on pg. 46.

Calibration details - Display Only
The calibration number, calibration code, calibration name, and calibration type of the active calibration.

Product #: (FE) U - L
The product code, product name, and product number of the active product.

Gross Preset: (FE) U - L - P
Preset value according to gross volume. *This field will be Net Preset when the active product is temperature compensated.* See preset directions on pg. 46.

Price Preset: (FE) U - L - P
Preset value according to price.

Price/Unit: Display Only
The active price per unit of measure. This field can be locked in the Setup POS screen **Lock Price?** field.

Tax Code: Display Only
The tax code designated to the active product.

Volume Discount: Display Only
The volume discount designated to the active product. This field can be locked in the Setup POS screen **Lock Discount Categories?** field.

Cash Discount: Display Only
The cash discount designated to the active product. This field can be locked in the Setup POS screen **Lock Discount Categories?** field.

Auxiliary 1 Output: (LB) U - L
Determines when to activate the Auxiliary 1 component. Common Auxiliary 1 components are pump controls, additive injectors, and alarms. The options include:

off

On

On During Delivery

Monitor Flowrate activates Auxiliary 1 at the beginning of the delivery. Auxiliary 1 stays active below a 40 units/time flowrate and deactivates over 40 units/time flowrate

DELIVERY SETUP		1
Gross Quantity:	34.1 GALLONS	
2 PD1 DIESEL NET	DISTALLATE	
Product #:	PD4	DIESEL NET 4
Gross Preset:	0.0 GALLONS	
Price Preset:	\$ 0.00	
Price/Unit:	\$ 3.8900	
Tax Code:	DARK CO.	
Volume Discount:	1	
Cash Discount:	EARLY PAYMENT	
Auxiliary 1 Output:	ON DURING DELIVERY	
Auxiliary 2 Output:	FLOW DIRECTION	
Toggle Flow Rate:	0.0	
Preset Type:	CLEAR	
No-Flow Timer:	180	
Add Miscellaneous Charges		
Next/Previous Screen		

OPERATION - DELIVERY SETUP (POS)

DELIVERY SETUP 1 (POS) (continued)

Auxiliary 2 Output: (LB) U - L

Determines when to activate the Auxiliary 2 component. Common Auxiliary 2 components are pump controls, additive injectors, and alarms. The options include:

- Off
- On
- On During Delivery

Flow Direction activates Auxiliary 2 according to the Flow Direction field on the System Setup 1 screen

Toggle Flow Rate: (FE) U - L

The flow rate value at which Auxiliary 1 activates in the **Toggle Flow Rate:** mode. Auxiliary 1 remains activated above the set flow rate value and deactivates when the flow rate falls below the value. A common output is an air operated valve (AOV) on the pump. When the flow rate value is attained, the AOV is activated switching the pump from low bypass pressure mode to full flow fuel mode (high bypass pressure). When the flow rate falls below the set value, the AOV deactivates and the pump returns to low flow. Another possible output is the engine throttle—to increase and decrease the RPM of the pump shaft. In applications such as these, the flow rate value in this field should be below the low flow rate with a fully open nozzle or the output will never turn on. Another application of this field is to set the value as a maximum flow rate at which a valve should be closed. On fuel delivery trucks, flow valves often activate an internal switch at approximately 18 GPM (68 LPM).

Preset Type: (LB) U - L

Provides four options for handling preset deliveries.

- Clear** resets the preset values to 0 after the current delivery is ended.
- Retain** maintains the preset values to be used again on the next delivery.
- Multiple** allows more than one preset to be run before a delivery ticket is printed. Delivery ticket printed with PRINT command.
- Inventory** maintains the remaining preset amount between deliveries. Typically used to indicate the remaining volume in the vehicle tank.

No-Flow Timer: (FE) U - L

The amount of time until the LCR 600 ends a delivery and prints a ticket after it senses that no product is flowing through the meter. The time can be set from 0 to 3600 seconds. If the time is set as 0, the feature is deactivated and the message “Multiple Deliveries at One Site” will be printed on the delivery ticket. If the value is greater than 180, the message “Multiple Deliveries at One Site” will be printed on the delivery ticket. The No-Flow Timer protects product from being delivered to unauthorized locations sometimes referred to as “riding the ticket”. Increasing the value allow fuelers to deliver fuel to more than one tank (or fueling point) at a single site and print one ticket that includes every tank at that site. The No-Flow Timer is not active in the calibration mode.

Add Miscellaneous Charges: S

Opens the Miscellaneous Charges list box.

Security Clearance

- L - Locked
- U - Unlocked
- C - Weights & Measures Calibration
- P - Stop/Pause
- F - Factory

Field Type

- FE - Field Edit Box**
- LB - List Box**

DELIVERY SETUP 2 (POS)

Delivery Setup screen for LCR 600's with the POS upgrade

Gross Quantity: *Display Only*

The quantity according to gross volume. *This field will be Net Quantity when the active product is temperature compensated.* See preset directions on pg. 46.

Calibration details - Display Only

The calibration number, calibration code, calibration name, and calibration type of the active calibration.

Product #: (FE) U - L

The product code, product name, and product number of the active product.

Set All Product Pricing: U - L - P

Opens the Product Price Entry Screen where the prices for all products can be changed.

Ticket Header Text: (FE) U

Supplies 12 lines where you can enter text for the ticket header. Every delivery ticket printed by the LCR 600 will print this text at the top of every ticket.

```

DELIVERY SETUP 2
Gross Quantity:          34.1 GALLONS
2 PDI DIESEL            GASOLINE
Product #: P4           DIESEL NET 4
Gross Preset:          0.0 GALLONS
See All Product Pricing
Ticket Header Text
1: Murphy Tank
2: 45557 Harwick Hiway
3: Conrad, Montana 59425
4:
5:
6:
7:
8:
9:
10:
Next/Previous Screen
    
```

DELIVERY SETUP 3 (POS)

Delivery Setup screen for LCR 600's with the POS upgrade

Product & Calibration details (FE) U - L

C1 PT1 GAS 91 Gasoline
 The calibration number, calibration code, calibration name and calibration type of the active calibration

Shift Start: Display Only

Date and time when the active shift started.

Deliveries: Display Only

Number of deliveries for the active shift.

Shift Net: Display Only

Net volume delivered during the active shift.

Shift Gross: Display Only

Gross volume delivered during the active shift.

Clear Shift: (LB) U - L

Resets active shift data.

Net Totalizer: Display Only

Net volume delivered by the LCR 600. Can only be reset in calibration position or with a clear all.

Gross Quantity: Display Only

Gross volume delivered by the LCR 600. Can only be reset in calibration position or with a clear all.

```

DELIVERY SETUP 3
1 PT1 GAS 91            GASOLINE
Shift Start:          06/29/09 17:36:57
Deliveries:          4
Shift Net:           0.0 GALLONS
Shift Gross:         62.8 GALLONS
Clear Shift?          NO

Net Totalizer:
Gross Totalizer:     141.77 GALLONS
Next/Previous Screen
    
```

Security Clearance
 L - Locked
 U - Unlocked
 C - Weights & Measures Calibration
 P - Stop/Pause
 F - Factory

Field Type
FE - Field Edit Box
LB - List Box

Diagnostics and Troubleshooting Overview

The LCR 600 provides tools for diagnosing and troubleshooting itself as well as other aspects of the meter system. The three main diagnostic tools are error messages, diagnostic and status screens, and diagnostic tickets. Error messages will pop up on the LCR 600 when the register can not continue its current function without an adjustment in the current settings. The diagnostic and status screens provide a detailed account of the status of the LCR 600. Diagnostic tickets provide a rundown of calibration data, system identification information, temperature probe data, error messages, and other useful bits of information. These three tools can help you pinpoint any issues occurring within the system and the LCR 600 and maintain an accurate, efficient, and safe fluid measurement system.

Error Messages

The LCR 600 identifies entry errors and system errors as soon as they occur. When an error occurs, a shaded box with a short description of the error will appear on the display. The error might also include additional instructions or options. If necessary, the additional options will give you the opportunity to open the diagnostic screens. In many error cases, you will also want to print a diagnostic ticket (see page 63). The list below explains LCR 600's error messages and possible corrective actions. If the suggestions listed are not successful, consult the troubleshooting section. If the troubleshooting tips do not help, call an authorized Liquid Controls service provider.

DELIVERY ERROR MESSAGES

These messages may be displayed when the LCR 600 is attempting to start, in the midst, or finishing a delivery.

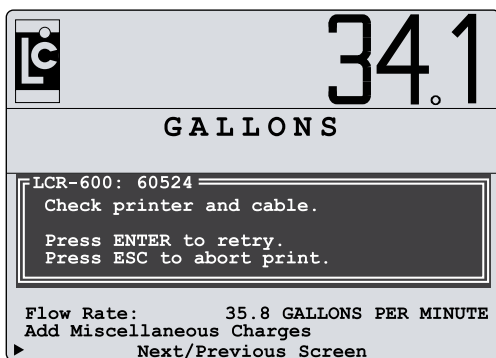

Delivery ticket pending

A new delivery was attempted but the previous delivery ticket was not printed in its entirety. Turn the selector switch to the PRINT position. Once the previous delivery ticket is printed, a new delivery can begin.

Check printer and cable

The printer is not responding. The most common cause is no ticket in the printer. Epson slip printers have a built in photo eye to detect if a ticket is in position. Other causes include faulty data cable or power cable and LCR 600 circuit board failure.

ROM CHECKSUM ERROR

The program memory space of the LCR 600 has been corrupted. If this error occurs, the unit must be reflashed with the control software before any deliveries can be made. Flash instructions are available on the www.lcmeter.com website.

TEMPERATURE ERROR

The temperature circuit returned an error or the temperature calibration data is in error. Check the temperature probe and its connections. A broken temperature probe wire is the most common cause of this error. See the troubleshooting section for more information (see page 65).

VCF DOMAIN ERROR

The calculated temperature falls outside the allowable range for the current compensation parameter. Verify that the product compensation type is correct on the Calibration Setup 2 screen (See page 35).

PULSER FAILURE

The number of pulser faults exceeds the allowable amount. Pulser faults typically occur in high vibration environments or when the flow rate is highly throttled. The LCR 600 allows a maximum of five times the number of pulses required for the least significant displayed digit or 0.1% of the pulses generated for the current delivery. This equation can not be altered. Liquid Controls is not responsible for pulser failures caused by excessive system vibrations. See the troubleshooting section for more information (see page 66).

METER CALIB ERROR

The product selected for delivery has not been calibrated. Select a calibrated product.

NO FLOW STOP ERROR

The no flow timer expired and terminated the delivery. This is not an error condition. See the Delivery Setup 1 to change the no flow timer.

POWER FAIL ERROR

The delivery ended due to a loss of input voltage. Check the power supply and wiring to the LCR 600. Check the in-line fuse. See the troubleshooting section for more information (see page 65).

PRESET ERROR

When accessing a preset field, a flash memory error was detected.

TERMINAL NOT CONNECTED

A terminal connection was disconnected during a delivery. Check the cables and connectors for broken wires and loose connections.

DATA ACCESS ERROR

A flash memory error occurred.

INIT WARNING

This message appears when **No-Flow Timer** or the **Ticket Required?** fields return an error. If this error occurs, the delivery can continue but default values **180** and **Yes** are used.

RUN TIME ERROR MESSAGES

These messages may be displayed if an error occurs while the system is running.

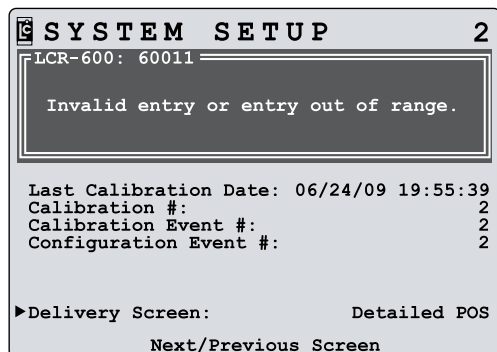

Invalid entry or entry out of range

The value entered into the field edit box is outside of the range specified for the field. Reenter the value.

FLASH CRC FAILURE

The CRC stored with an LCR 600 data block indicates the data or CRC has been corrupted. A rebuild operation could possibly fix the problem. If not, try a clear all (Call Liquid Controls for clear all instructions). If that does not work, hardware may be at fault and the unit should be returned to Liquid Controls for more analysis. Before starting a clear all operation, print a calibration ticket.

FLASH WRITE FAILURE

A failure detected while a data block was being written to the flash memory. See Flash CRC Failure above for corrective actions

FLASH NOT INITIALIZED

The selector switch was not in the CALIBRATION position when a **Clear All** or **Rebuild** was attempted.

Invalid entry or entry out of range

The data entered was not within the required range limits for the specific field.

Duplicate flow rates not allowed

This message only appears when setting up multi-point calibration. When calibrating a multi-point meter, each linearization point must have a unique flow rate. This message is displayed if a duplicate flow rate is entered.

Adjacent linearization points out of 0.25% range

This message only appears when setting up multi-point calibration. When calibrating a multi-point meter, adjacent linearization points must be within a 0.25% correction of each other. To avoid this error, select an additional flow rate and correction factor between the two points. More than one additional point may be required.

DIAGNOSTICS

DIAGNOSTICS

Gross Count: *Display Only*

The gross volume of the active delivery.

Flow Rate: *Display Only*

The current flow rate of the active delivery.

Unit of Measure: (LB) C

The unit of flow measurement.

Gallons • Litres • Cubic M • Lbs (pounds) •
Kgs • Barrels • Other

Flow Rate Base: (LB) C

The time unit of the flow rate.

Per Second • Per Minute • Per Hour

Pulser Reversals: *Display Only*

The number of pulser reversal occurrences.

Supply Voltage: *Display Only*

The current voltage being supplied to the LCR 600.

Software Revision: *Display Only*

The current version of LCR 600 software installed.

Language Revision: *Display Only*

The current version of language software installed on the LCR 600.

Ticket Revision: *Display Only*

The current version of ticket revision software installed on the LCR 600.

DIAGNOSTICS	
Gross Count:	2.7 GALLONS
Flow rate:	0.0
Unit of Measure:	GALLONS
Flow Rate Base:	PER MINUTE
Pulser Reversal:	0
Supply Voltage:	14.6
Software Revision:	SD600A1.40
Language Revision:	SL600A1.03
Ticket Revision:	ST600A1.02

Next/Previous Screen

Field Type

FE - Field Edit Box

LB - List Box

MACHINE STATUS

Security: *Display Only*

A description of the active security level.

Idle • Unlocked Idle • Delivery Paused • Delivery
Active • W&M Idle • Factory Idle

Switch: *Display Only*

The position of the selector switch.

Run • Stop • Print • Shift Print • Calibrate

State: *Display Only*

The current processing activity of the LCR 600.

Run • Stop • End Delivery • Auxiliary • Shift • Calibrate • Waiting for No-Flow • Unknown

Printing? *Display Only*

Is the printer currently printing?

Other Errors? *Display Only*

Are there any other errors being reported by the LCR?

Printer Status C - U - L - P

Select this field to open the Printer Status screen. Pg. 58.

Delivery Status C - U - L - P

Select this field to open the Delivery Status screen. Pg. 59.

Delivery Code C - U - L - P

Select this field to open the Delivery Code screen. Pg. 60.

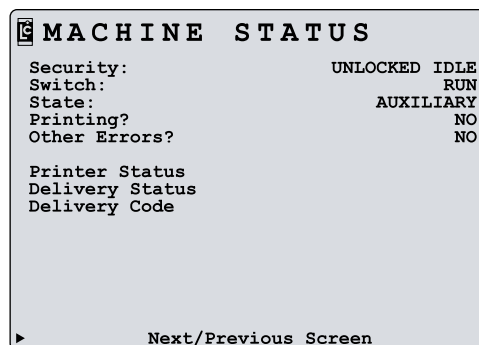

Security Clearance

L - Locked
U - Unlocked
C - Weights & Measures Calibration
P - Stop/Pause
F - Factory

DIAGNOSTICS - PRINTER STATUS

PRINTER STATUS

Delivery Ticket? *Display Only*
Has a delivery ticket been requested?

Shift Ticket? *Display Only*
Has a shift ticket been requested?

Diagnostic Ticket? *Display Only*
Has a diagnostic ticket been requested?

Pass-Through Print? *Display Only*
Is text from the host in the LCR print buffer?

Printer Error? *Display Only*
Has an error been detected with the printer?

Printer Busy? *Display Only*
Has the print processor began to print a ticket?

PRINTER STATUS	
Delivery Ticket?	NO
Shift Ticket?	NO
Diagnostic Ticket?	NO
Pass-Through Print?	NO
Printer Error?	NO
Printer Busy?	NO

▶ Next/Previous Screen

DELIVERY STATUS

ROM Check Sum? *Display Only*

Has a delivery not started due to the checksum of the LectroCount program code space failing?

Temperature? *Display Only*

Has the current delivery not started (or was terminated) due to an error with the temperature reading hardware?

Watchdog? *Display Only*

Was the processor reset due to a LectroCount watchdog time out error?

VCF Setup? *Display Only*

Was there an error setting up the volume compensation factor for the current product?

VCF Domain? *Display Only*

Did the temperature of the product go outside the valid range for the compensation type of the product?

Meter Calibration? *Display Only*

Did an error occur while setting up the meter calibration for the current delivery?

Pulser Failure? *Display Only*

Did the current delivery terminate due to too many pulser faults?

Preset Stop? *Display Only*

Was the gross or net preset volume reached?

No-Flow Stop? *Display Only*

Was the current delivery stopped due to no-flow being detected through the meter for a specified amount of time?

Stop/Pause Request? *Display Only*

Was a stop activated by the selector switch during an active delivery?

Print/End Request? *Display Only*

Was a print activated by the selector switch during an active delivery?

Power Failure? *Display Only*

Did a delivery end due to a power fail condition for more than 15 seconds?

Preset Error? *Display Only*

Did a delivery end due to an error condition while attempting to set up a gross or net preset?

Printer? *Display Only*

Does the current delivery require a printed ticket but the printer is off-line or busy?

Data Access? *Display Only*

Did a data access error occur during the delivery which was critical to the delivery?

DELIVERY STATUS	
ROM Check Sum?	NO
Temperature?	NO
Watchdog?	NO
VCF Setup?	NO
VCF Domain?	NO
Meter Calibration?	NO
Pulser Failure?	NO
Preset Stop?	NO
No-Flow Stop?	NO
Stop/Pause Request?	NO
Print/End Request?	NO
Power Failure?	NO
Preset Error?	NO
RS-232 Lap Pad?	NO
Printer?	YES
Data Access?	NO
Next/Previous Screen	

DIAGNOSTICS - DELIVERY CODE

DELIVERY CODE

Delivery Ticket? *Display Only*

Is a delivery ticket is pending?

A new delivery cannot be started until this field is cleared by successfully printing the last delivery ticket.

Shift Ticket? *Display Only*

Has a shift ticket been requested and waiting to be printed?

Flow Active? *Display Only*

Is the flow active during a delivery?

*This field changes with the **Delivery Active?** field, but it also turns off when a delivery is paused and turned on when the delivery is resumed.*

Delivery Active? *Display Only*

Is a delivery active?

Gross Preset Active? *Display Only*

Is the current delivery a gross preset?

Net Preset Active? *Display Only*

Is the current delivery a net preset?

Stop/Gross Preset? *Display Only*

Has the current delivery been stopped by reaching a gross preset value?

Stop/Net Preset? *Display Only*

Has the current delivery been stopped by reaching a net preset value?

VCF Active? *Display Only*

Is the volume of the current delivery compensated according to temperature?

S1 Closed? *Display Only*

Is the S1 solenoid closed?

During preset deliveries, the S1 solenoid should be open at full product flow and closed at dwell flow.

Delivery Beginning? *Display Only*

Is a delivery in the process of being started?

New Delivery Queued? *Display Only*

Has a new delivery has been queued in the LCR 600?

DELIVERY CODE	
Delivery Ticket?	NO
Shift Ticket?	NO
Flow Active?	NO
Delivery Active?	NO
Gross Preset Active?	NO
Net Preset Active?	NO
Stop/Gross Preset?	NO
Stop/Net Preset?	NO
VCF Active?	NO
S1 Closed?	NO
Delivery Beginning?	NO
New Delivery Queued?	NO
Init Warning?	NO
Config Event?	NO
Calib Event?	NO

Next/Previous Screen

Diagnostic Tickets and Error Message Examples

To print a diagnostic ticket:

1. Press RELEASE on the printer. Insert a blank delivery ticket.
2. Press FORWARD on the printer to engage the ticket.
3. Turn the LCR 600 selector switch to SHIFT PRINT for less than 2 seconds and turn the switch to PRINT.
4. When the ticket finishes printing, press RELEASE on the printer. Remove the ticket.
5. Insert a blank delivery ticket and press FORWARD on the printer to engage the new ticket

*Diagnostic tickets can run over the length of a standard slip printer ticket. Two tickets may be required. When the printer stops printing, replace the ticket and press **ENTER** on the LCR 600.*

```

CALIBRATION TICKET #          28
CALIBRATION EVENT #          2
CONFIGURATION EVENT #        17
CALIBRATION DAT      07/13/11 15:02:54
METER IDENTIFIER      S1900
SERIAL NUMBER        9280055
CALIBRATION NUMBER 1    GASOLINE
  COMP TYPE          NONE
  NONE
  PULSES            33.1996 GALLONS
CALIBRATION NUMBER 2    DISTILLATE
  COMP TYPE          NONE
  NONE
  PULSES            553.3996 GALLONS
CALIBRATION NUMBER 3    LPG
  COMP TYPE          NONE
  NONE
  PULSES            242.9572 GALLONS
RATE %ERROR   RATE %ERROR
60.00 -0.122  40.00 -0.300
20.00 -0.451
CALIBRATION NUMBER 4
  COMP TYPE          NONE
  NONE
  PULSES            0.0000 GALLONS
CALIBRATION NUMBER 5
  COMP TYPE          NONE
  NONE
  PULSES            0.0000 GALLONS
CALIBRATION NUMBER 6
  COMP TYPE          NONE
  NONE
  PULSES            0.0000 GALLONS
CALIBRATION NUMBER 7
  COMP TYPE          NONE
  NONE
  PULSES            0.0000 GALLONS
CALIBRATION NUMBER 8
  COMP TYPE          NONE
  NONE
  PULSES            0.0000 GALLONS
CALIBRATION NUMBER 9
  COMP TYPE          NONE
  NONE
  PULSES            0.0000 GALLONS
    
```

Diagnostic Ticket (Calibration Ticket)

```

CALIBRATION NUMBER 10
  COMP TYPE          NONE
  NONE
  PULSES            0.0000 GALLONS
CALIBRATION NUMBER 11
  COMP TYPE          NONE
  NONE
  PULSES            0.0000 GALLONS
CALIBRATION NUMBER 12
  COMP TYPE          NONE
  NONE
  PULSES            0.0000 GALLONS
CALIBRATION NUMBER 13
  COMP TYPE          NONE
  NONE
  PULSES            0.0000 GALLONS
CALIBRATION NUMBER 14
  COMP TYPE          NONE
  NONE
  PULSES            0.0000 GALLONS
CALIBRATION NUMBER 15
  COMP TYPE          NONE
  NONE
  PULSES            0.0000 GALLONS
CALIBRATION NUMBER 16
  COMP TYPE          NONE
  NONE
  PULSES            0.0000 GALLONS
FIRMWARE
SD600v1.00
SL600v1.00
SL600v1.00
TEMPERATURE          71.96 DEG. F
ADC OFFSET           -124.57 DEG. C
ADC SLOPE            0.0155 /BIT
TEMP ZERO            0.00 DEG. F
PULSER FAULTS        0
LAST GROSS           16.9 GALLONS
LAST NET              0.0 GALLONS
    
```

Diagnostic Ticket (Calibration Ticket) continued

TROUBLESHOOTING

Troubleshooting the LCR 600

The troubleshooting section of this manual covers the common problem situations. Call your local authorized Liquid Controls service provider or the Liquid Controls electronics service department if the troubleshooting section does not address the situation.

When troubleshooting the LCR 600 follow these guidelines:

- Check for proper operating voltages before changing the circuit board. If the circuit board needs to be changed, be sure to remove all power to the LCR 600.
- The error message or a diagnostic ticket will contain an error message that can be useful in troubleshooting. Examine the diagnostic screens on the LCR 600 or the diagnostic ticket to make sure all set-up fields are accurate, e.g. pulses per unit volume, temperature coefficient and base temperature. Print a diagnostic ticket by moving the red selector switch to "SHIFT PRINT" for less than two seconds.
- Never remove a terminal block or jumper with the power on.
- Never install a terminal block or jumper with the power on.
- Never force a terminal block into its location.
- Never exchange or reposition terminal blocks on the circuit board.
- In case of a major problem such as a burned or water-damaged circuit board, evaluate possible causes before replacing it and turning the power back on.
- Isolate the problem before changing the circuit board.
- Return faulty circuit boards with the proper forms, concisely completed.

PROBLEM	PROBABLE CAUSE	SOLUTION
Unit will not power up or no display.	1. Inadequate supply voltage. +9 to 28VDC is required for operation.	<ol style="list-style-type: none"> 1. With the key in the accessory position, check the battery voltage to the circuit board at J6. Use terminal #11 as positive and terminal #12 as DC ground. While the LCR 600 will power-up at +9VDC, it is recommended that the input be at least +12.6VDC. 2. Check the 7.5A, in-line fuse (PN 70985) for continuity. It is located on the accessory power line. Replace if necessary.
Unit blows 7.5A fuse.	1. +12VDC Battery line is shorted to ground.	<ol style="list-style-type: none"> 1. For safety reasons, remove the 7.5A in-line fuse from the accessory power cable. 2. Remove the J6 terminal block. Inspect for stray wire stands and visible shorts. 3. Using a multimeter, take a reading across terminal 11 and terminal 12 on the J6 terminal block. The terminals should be open. If the multimeter shows a short, replace the power cable (PN 81512). 4. Inspect the power cable for damaged insulation that could cause a short between the wire and the chassis (or other nearby metal). If the cable is damaged, replace it. 5. Replace the 7.5A fuse (PN 70985) and re-install the J6 connector. 6. If the 7.5A fuse blows again, replace the LCR 600 circuit board.

PROBLEM	PROBABLE CAUSE	SOLUTION										
“Power Failure” appears diagnostic ticket or LCR 600 shuts down unexpectedly.	<ol style="list-style-type: none"> 1. Power to LCR 600 interrupted during delivery. 2. Static discharge. 	<ol style="list-style-type: none"> 1. Check accessory power cable for damage. Ensure that the power, common and ground wires (11, 12 and 13) on power connector J6 are secure. 2. Turn on all truck accessories (head lamps, 2-way radio, heater, etc.). Engage the hose reel and monitor the DV voltage at J6 using terminal 11 as positive and terminal 12 as ground. If the voltage drops below +10VDC, the truck electrical system may not 3. Verify proper grounding of the LCR 600. Refer to the installation manual for proper grounding procedures. 										
Epson printer release light flashes.	<ol style="list-style-type: none"> 1. Low voltage to the Epson printer. 	<ol style="list-style-type: none"> 1. Check the battery voltage for a minimum of +12.6VDC. 2. Under extreme cold conditions, the printer may not operate. Warm up the cab of the vehicle. 3. If the release light continues to flash, replace the Epson 295 Printer (PN E49001). 										
No power indicator lights to the Epson printer.	<ol style="list-style-type: none"> 1. No power to the Epson printer. 	<ol style="list-style-type: none"> 1. Verify that the power switch is in the ON position. This switch is located on the left-hand side of the Epson 295 printer. 2. Check the printer power cable (PN 825001) to ensure that it is seated in the port properly. If the problem persists, replace the power cable. If the problem continues replace the Epson printer (PN E49001). 										
“Temperature Error” appears on diagnostic ticket or on the LCR 600.	<ol style="list-style-type: none"> 1. Open or shorted circuit between the RTD probe and LCR 600. 	<ol style="list-style-type: none"> 1. Remove terminal block J14 from the circuit board. On the terminal block, measure and record the resistance between the following pins: <table style="margin-left: 40px; border: none;"> <thead> <tr> <th style="text-align: left;">TERMINAL #</th> <th style="text-align: left;">CONTINUITY</th> </tr> </thead> <tbody> <tr> <td>J14 #20 to #22</td> <td>100Ω ±20Ω</td> </tr> <tr> <td>J14 #20 to #23</td> <td>100Ω ±20Ω</td> </tr> <tr> <td>J14 #21 to #22</td> <td>100Ω ±20Ω</td> </tr> <tr> <td>J14 #21 to #23</td> <td>100Ω ±20Ω</td> </tr> </tbody> </table> 2. If the readings are not within the above tolerances, replace the RTD probe (PN 71130). 	TERMINAL #	CONTINUITY	J14 #20 to #22	100Ω ±20Ω	J14 #20 to #23	100Ω ±20Ω	J14 #21 to #22	100Ω ±20Ω	J14 #21 to #23	100Ω ±20Ω
TERMINAL #	CONTINUITY											
J14 #20 to #22	100Ω ±20Ω											
J14 #20 to #23	100Ω ±20Ω											
J14 #21 to #22	100Ω ±20Ω											
J14 #21 to #23	100Ω ±20Ω											
Product flow does not register on LCR 600 display.	<ol style="list-style-type: none"> 1. Pulser shaft is not turning with product flow. 2. Pulser failure. 	<ol style="list-style-type: none"> 1. Manually spin the pulser shaft and monitor the LCR 600 display. 2. If the LCR 600 display counter increments, this may indicate a mechanical problem. Contact your local Liquid Controls distributor or the Liquid Controls service department for assistance. 3. If the LCR 600 display counter does not increment, see “Pulser Failure” in the following troubleshooting section. 										

TROUBLESHOOTING

PROBLEM	PROBABLE CAUSE	SOLUTION																																
<p>“Pulser Failure” appears on the diagnostic ticket or on the LCR 600 display.</p>	<p>1. Missing pulse counts. 2. Excessive reversals.</p> <p><i>Pulser faults generally occur in a high vibration environment. Liquid Controls is not responsible for pulser failures caused by excessive system vibrations.</i></p>	<p>1. Using a multimeter, measure the following DC voltages on terminal block J8, while J8 is connected to the circuit board. Use terminal 37 as ground reference.</p> <table border="0"> <thead> <tr> <th>TERMINAL #</th> <th>VOLTAGE</th> </tr> </thead> <tbody> <tr> <td>J8 #32</td> <td>+5 VDC</td> </tr> <tr> <td>J8 #33</td> <td>0 or +5VDC</td> </tr> <tr> <td>J8 #34</td> <td>0 or +5VDC</td> </tr> </tbody> </table> <p>2. If the terminals show the preceding voltages, check for loose pulser wiring connections. If no loose connections are found, replace the encoder harness. (PN 81584 – for Series E2611X and E2612X) (PN 81412 – for Series E2605X and E2606X) or (Hard wires for POD pulser.)</p> <table border="0"> <thead> <tr> <th>TERMINAL #</th> <th>VOLTAGE</th> </tr> </thead> <tbody> <tr> <td>J8 #32</td> <td>0 VDC</td> </tr> <tr> <td>J8 #33</td> <td>+1-3VDC</td> </tr> <tr> <td>J8 #34</td> <td>+1-3VDC</td> </tr> </tbody> </table> <p>4. If the LCR 600 still shows a pulser failure, insert a ticket into the Epson printer and begin a delivery. With product flowing through the meter, measure the following DC voltages on the terminal block.</p> <table border="0"> <thead> <tr> <th>TERMINAL #</th> <th>VOLTAGE</th> </tr> </thead> <tbody> <tr> <td>J8 #32</td> <td>0 VDC</td> </tr> <tr> <td>J8 #33</td> <td>+1-3VDC</td> </tr> <tr> <td>J8 #34</td> <td>+1-3VDC</td> </tr> </tbody> </table> <p>5. If the voltages shown below are observed, ensure that the pulser shaft is rotating. Look for any mechanical problems that may cause either the meter or the pulser shaft to lock up. If the Lap Pad continues to indicate a pulser failure, replace the pulser (Part # 81582 for Series E2611X and E2612X) (Part # 81170 for Series E2605X and E2606X) or (Part # 81159 for POD pulser)</p> <table border="0"> <thead> <tr> <th>TERMINAL #</th> <th>VOLTAGE</th> </tr> </thead> <tbody> <tr> <td>J8 #32</td> <td>+5 VDC</td> </tr> <tr> <td>J8 #33</td> <td>0 or +5VDC</td> </tr> <tr> <td>J8 #34</td> <td>0 or +5VDC</td> </tr> </tbody> </table>	TERMINAL #	VOLTAGE	J8 #32	+5 VDC	J8 #33	0 or +5VDC	J8 #34	0 or +5VDC	TERMINAL #	VOLTAGE	J8 #32	0 VDC	J8 #33	+1-3VDC	J8 #34	+1-3VDC	TERMINAL #	VOLTAGE	J8 #32	0 VDC	J8 #33	+1-3VDC	J8 #34	+1-3VDC	TERMINAL #	VOLTAGE	J8 #32	+5 VDC	J8 #33	0 or +5VDC	J8 #34	0 or +5VDC
TERMINAL #	VOLTAGE																																	
J8 #32	+5 VDC																																	
J8 #33	0 or +5VDC																																	
J8 #34	0 or +5VDC																																	
TERMINAL #	VOLTAGE																																	
J8 #32	0 VDC																																	
J8 #33	+1-3VDC																																	
J8 #34	+1-3VDC																																	
TERMINAL #	VOLTAGE																																	
J8 #32	0 VDC																																	
J8 #33	+1-3VDC																																	
J8 #34	+1-3VDC																																	
TERMINAL #	VOLTAGE																																	
J8 #32	+5 VDC																																	
J8 #33	0 or +5VDC																																	
J8 #34	0 or +5VDC																																	

PROBLEM	PROBABLE CAUSE	SOLUTION										
Valve will not open.	<ol style="list-style-type: none"> 1. Solenoids are inactive or inoperative. 2. Foreign debris in system. 	<ol style="list-style-type: none"> 1. Insert a delivery ticket into the Epson printer and start a delivery. 2. Move the selector switch from RUN to STOP and back to RUN. Listen for an audible clicking sound from the solenoids. 3. If there is an audible click from the solenoid (but still no flow), this may be an indication of a mechanical problem with the main valve or its associated components. Contact your local Liquid Controls distributor or the Liquid Controls service department for assistance. 4. If there is no audible click from the solenoid, check the voltage to pin #s 14, 15, 16 and 17 of terminal block J13. While still in RUN mode, use a multimeter to measure the following DC voltages on the circuit board. Use J8 pin #38 as a ground. <table style="margin-left: 20px; border: none;"> <thead> <tr> <th style="text-align: left;">TERMINAL #</th> <th style="text-align: left;">VOLTAGE</th> </tr> </thead> <tbody> <tr> <td>J13 #14</td> <td>12.0VDC ±1.5VDC</td> </tr> <tr> <td>J13 #15</td> <td>1.0VDC ± 0.5VDC</td> </tr> <tr> <td>J13 #17</td> <td>12.0VDC ±1.5VDC</td> </tr> <tr> <td>J13 #18</td> <td>1.0VDC ±0.5VDC</td> </tr> </tbody> </table> 5. If the above voltages are correct, this may be an indication of a problem with the valve or its associated components. Contact your local Liquid Controls distributor or the Liquid Controls service department for assistance. 6. If the above voltage are incorrect, replace the solenoids (PN varies depending on system). If the valve problem persists, replace the LCR 600 circuit board (PN 84040). 	TERMINAL #	VOLTAGE	J13 #14	12.0VDC ±1.5VDC	J13 #15	1.0VDC ± 0.5VDC	J13 #17	12.0VDC ±1.5VDC	J13 #18	1.0VDC ±0.5VDC
TERMINAL #	VOLTAGE											
J13 #14	12.0VDC ±1.5VDC											
J13 #15	1.0VDC ± 0.5VDC											
J13 #17	12.0VDC ±1.5VDC											
J13 #18	1.0VDC ±0.5VDC											

LCR 600 INPUTS AND OUTPUTS

LectroCount LCR 600 Fields for Inputs/Outputs			
Input/Output Component	Related Settings and Fields	Screen Locations	Selector Switch Commands
ETVC PROBE	Temperature:	Delivery - System Setup 2	
	Temperature Offset:	System Setup 2	
	Temperature Offset:	Calibration 2	
	Compensation Type: Delivery Ticket - Shift Ticket Compensation Parameter: Delivery Ticket - Shift Ticket Base Temperature: Delivery Ticket - Shift Ticket	Calibration 2	
S1 SOLENOID	Net Preset:	Delivery - Delivery Setup 1	RUN, STOP, PRINT
	Gross Preset:		
	Price Preset:		
	S1 Close:	Calibration Setup 1	
	No-Flow Timer:	Delivery Setup 1	
S2 SOLENOID	Net Preset:	Delivery - Delivery Setup 1	
	Gross Preset:		
	Price Preset:		
	S1 Close:	Calibration Setup 1	
S3 SOLENOID	No Related Fields		
OPTICAL SENSOR	No Related Fields		
DP TRANSDUCER	dP Shutdown Value:	System Setup 1	
INJECTOR, PUMP, SHUTDOWN DEVICE, ETC..	Auxiliary 1 Output:	Delivery Setup 1 or 2	
	Auxiliary 2 Output:		
	Toggle Flow Rate:		
INTERNAL PULSER	Flow Rate:	Delivery	
	Pulse Output Edge:	General Setup 1	
	Pulse Output Freq:		
	Pulses/Unit <k-Factor>:	Calibration Setup 1	
Prover Quantity:			

LectroCount LCR 600 Input and Output Devices

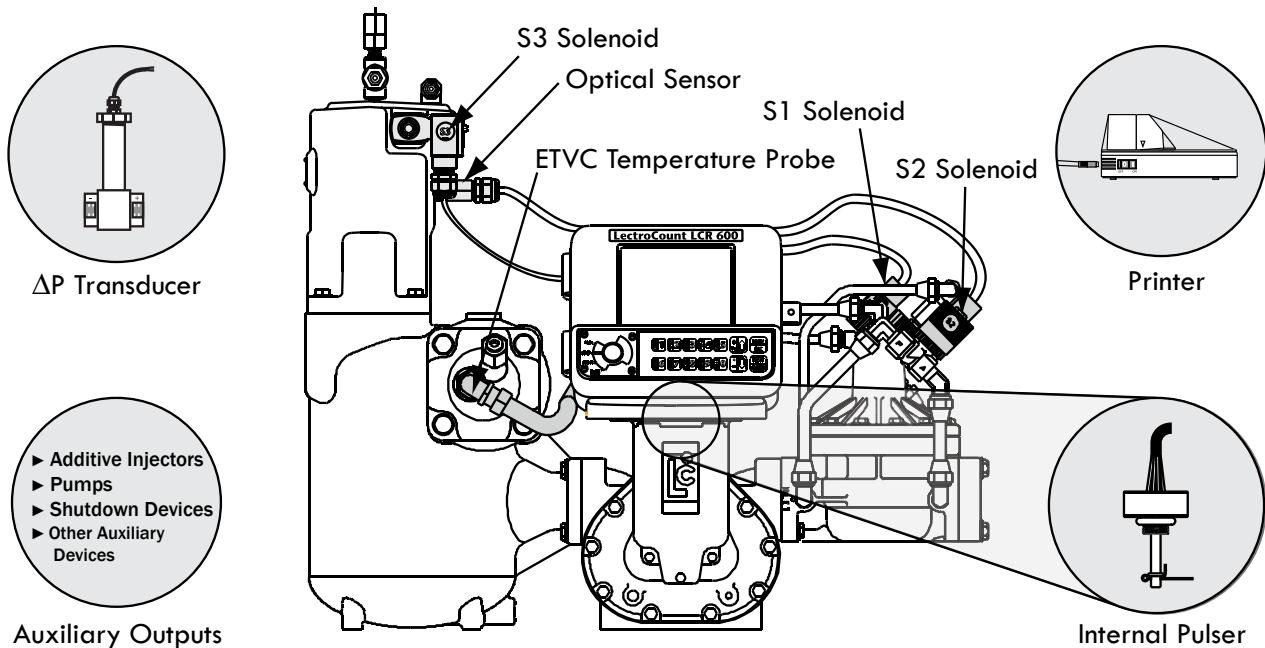

LCR 600 INPUTS AND OUTPUTS

LectroCount LCR 600 Fields for Inputs/Outputs			
Input/Output Component	Related Settings and Fields	Screen Locations	Selector Switch Commands
<p style="text-align: center;">PRINTER</p> <p>The type(s) of ticket that prints the field value is indicated to the right of the field.</p>	Product #: Delivery Ticket -Shift Ticket Code: (Product) Delivery Ticket -Shift Ticket Name: (Product) Delivery Ticket -Shift Ticket	Delivery - Delivery Setup 1 to 3 - Setup POS	<p>PRINT, SHIFT PRINT</p>
	Net Totalizer: Shift Ticket Gross Totalizer: Shift Ticket	Delivery - Calibration Setup 1 - Delivery Setup 3	
	Price/Unit: Delivery Ticket	Delivery - Delivery Setup 1 - Setup POS	
	Add Miscellaneous Charges Delivery Ticket Total Price: Delivery Ticket	Delivery - Delivery Setup 1	
	Tax/Unit: Delivery Ticket (no POS) Tax Code: Delivery Ticket Volume Discount: Delivery Ticket Cash Discount: Delivery Ticket Percent Tax: Delivery Ticket (no POS)	Delivery Setup 1 - Setup POS	
	Ticket Header Text Delivery Ticket - Shift Ticket	Delivery Setup 2 - General Setup 1	
	Shift Start: Shift Ticket Deliveries: Shift Ticket Shift Net: Shift Ticket Shift Gross: Shift Ticket	Delivery Setup 3	
	Unit ID: Shift Ticket - Delivery Ticket (ST203) Date Format: All Tickets Date: All Tickets Time: All Tickets Sale #: All Tickets Ticket #: All Tickets Print Gross and Parameter? Volume Corrected Messages?	General Setup 1	
	Date Format: All Tickets Date: All Tickets	General Setup 1 - Security - Advanced Features	
	Meter ID: Calibration Ticket - Delivery Ticket Decimal Digits: Residual Processing: Printer: Ticket Required?	System Setup 1	
	Unit of Measure: All Tickets	System Setup 1 - Diagnostics	
	Calibration Event: Calibration Ticket Configuration Event: Calibration Ticket RTD Offset: Calibration Ticket RTD Slope: Calibration Ticket	System Setup 2	
	Calibration #: Calibration Ticket	System Setup 2 - Calibration 1 - Setup POS - Advanced Features	
	Calibration Code: All Tickets Calibration Name: All Tickets Calibration Type: Calibration Ticket	Calibration 1	
	Compensation Type: Delivery Ticket - Shift Ticket Compensation Parameter: Delivery Ticket - Shift Ticket Base Temperature: Delivery Ticket - Shift Ticket Temperature: Calibration Ticket Auxiliary Quantity: All Tickets Auxiliary Unit of Measure: All Tickets	Calibration 2	
	Software Revision: Calibration Ticket Language Revision: Calibration Ticket Ticket Revision: Calibration Ticket	Diagnostics	
	LCR Serial ID: Calibration Ticket	Advanced Features	
	No Flow Timer	Delivery Setup 1	

LIQUID CONTROLS GROUP

IDEAL SOLUTIONS INTEGRATED SYSTEMS

LIQUID CONTROLS EUROPE • LIQUID CONTROLS SPONSLER

LIQUID CONTROLS • LIQUID CONTROLS INDIA

FAURE HERMAN • TOPTECH SYSTEMS

CORKEN • SAMPI



LIQUID CONTROLS

105 Albrecht Drive
Lake Bluff, IL 60044
(847) 295-1050

LIQUID CONTROLS EUROPE/SAMPI

Via Amerigo Vespucci 1
55011 Altopascio (Lucca), Italy
+39 0583 24751

LIQUID CONTROLS INDIA

808 VCCI Complex
GIDC Makarpura
Vadodara-390 101
Gujarat, India
+91 265 2631855

LIQUID CONTROLS SPONSLER

105 Albrecht Drive
Lake Bluff, IL 60044
(847) 295-1050

TOPTECH SYSTEMS

280 Hunt Park Cove
Longwood, FL 32750
(407) 332-1774

Nateus Business Park
Nieuwe Weg 1-Haven 1053
B-2070 Zwijndrecht (Antwerp), Belgium
+32 (0)3 250 60 60

FAURE HERMAN

Route de Bonnetable
B.P. 20154
72406 La Ferté-Bernard Cedex, France
+33 (0)2 43 60 28 60

6961 Brookhollow West Drive
Houston, TX 77040
(713) 623-0808

CORKEN

3805 Northwest 36th St.
Oklahoma City, OK 73112
(405) 946-5576

105 Albrecht Drive
Lake Bluff, IL 60044-2242
1.800.458.5262 • 847.295.1050
Fax: 847.295.1057
www.lcmeter.com

© 2010 Liquid Controls
Pub. No. 500356
(02/2010)

ISO 9001



DNV
CERTIFICATED FIRM
Certificate No. 08732

ISO 14001



DNV
CERTIFICATED FIRM
Certificate No. 05049