

MODELS

INT-69RT
INT-69R
INT-69T
(with RS232 &
RS422 Option)

INTELLECT-69

INSTALLATION & OPERATING INSTRUCTIONS

Version V_41

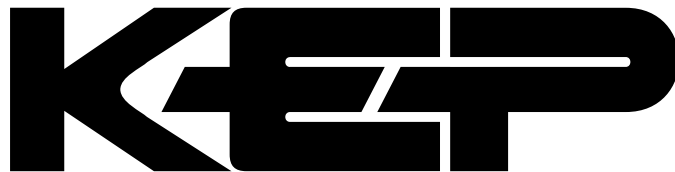

KESSLER-ELLIS PRODUCTS

10 Industrial Way East

Eatontown, NJ 07724

800-631-2165 • 732-935-1320

Fax: 732-935-9344

kep.com

<http://www.kep.com>

99318 01/27/10



Proprietary Notice

The information contained in this publication is derived in part from proprietary and patent data. This information has been prepared for the expressed purpose of assisting operating and maintenance personnel in the efficient use of the instrument described herein. Publication of this information does not convey any rights to use or reproduce it or to use for any purpose other than in connection with the installation, operation and maintenance of the equipment described herein.

Copyright 1990
Printed in USA. All Rights Reserved.



This instrument contains electronic components that are susceptible to damage by static electricity. Proper handling* procedures must be observed during the removal, installation, or handling of internal circuit boards or devices.

*Handling Procedure

1. Power to unit must be removed.
2. Personnel must be grounded, via wrist strap or other safe, suitable means, before any printed circuit board or other internal device is installed, removed or adjusted.
3. Printed circuit boards must be transported in a conductive bag or other conductive container. Boards must not be removed from protective enclosure until the immediate time of installation. Removed boards must be placed immediately in protective container for transport, storage, or return to factory.

Comments

This instrument is not unique in its content of ESD (electrostatic discharge) sensitive components. Most modern electronic designs contain components that utilize metal oxide technology (NMOS, CMOS, etc.). Experience has proven that even small amounts of static electricity can damage or destroy these devices. Damaged components, even though they appear to function properly, may exhibit early failure.

TABLE OF CONTENTS

SAFETY INSTRUCTIONS	1
DESCRIPTION & SPECIFICATIONS.....	2
MOUNTING.....	3
WIRING	4
TYPICAL WIRING	5
OPEN COLLECTOR & RELAY OPERATION	5
PROGRAMMING FLOWCHART.....	6
DEFINITIONS.....	7
FRONT PANEL OPERATIONS	10
PROGRAMMING	10
SETTING PRESETS & PANEL LOCK	15
RS 232/422 OPERATIONS	16
RS 232/422 WIRING	20
TROUBLESHOOTING GUIDE.....	21
WARRANTY	22
DECODING PART NUMBER	22



SAFETY INSTRUCTIONS

The following instructions must be observed.

- This instrument was designed and is checked in accordance with regulations in force EN 60950 (“Safety of information technology equipment, including electrical business equipment”).
A hazardous situation may occur if this instrument is not used for its intended purpose or is used incorrectly. Please note operating instructions provided in this manual.
- The instrument must be installed, operated and maintained by personnel who have been properly trained. Personnel must read and understand this manual prior to installation and operation of the instrument.
- The use of an external line fuse is recommended. Add or replace the external fuse with the following specified type and rating only:

<u>Input Power</u>	<u>Recommended Fuse</u>
115 VAC	100 mA slow blow fuse
230 VAC	50 mA slow blow fuse
12-24 VDC	250 mA slow blow fuse

Disconnect power supply before adding or replacing fuse!

- The manufacturer assumes no liability for damage caused by incorrect use of the instrument or for modifications or changes made to the instrument.

Symbols Used On Unit

<u>Number</u>	<u>Symbol</u>	<u>Publication</u>	<u>Description</u>
1	===	IEC 417, No. 5031	Direct current
2		IEC 417, No. 5172	Equipment protected throughout by DOUBLE INSULATION or REINFORCED INSULATION (equivalent to Class II of IEC 536–see annex H)
3		ISO 3864, No. B.3.1	Caution (refer to accompanying documents)

Technical Improvements

- The manufacturer reserves the right to modify technical data without prior notice.

DESCRIPTION & SPECIFICATIONS

Description:

Featuring 6 digits of bright, 7-segment LED displays, this unit is an integrating totalizer/ratemeter which accepts analog signal inputs. The unit can be field programmed to accept 0-20mA, 4-20mA, 0-5V, 0-10V or 1-5V signals. An optional Square Law input is available for inputs that require square root extraction. A 4-20mA output option is available to control strip recorders or other peripherals. Two assignable set points are standard for two stage shut off. The high and low scaling settings are programmable from the front panel. By pressing the "view" button, the unit will display: integrated total, rate, peak or valley. RS-422 or RS-232 serial communications are available options for data communication with a host computer.

Specifications:

Display: 6 digit, .55" high, LED.

Input Power: 110, 220 VAC \pm 15% or 12 to 24VDC.
Current: maximum 300 mA DC or 10.0 VA at rated AC voltage.

Output Power: (AC powered units only) + 24VDC.
@ 50 mA regulated \pm 5%

Temperature:

Operating: +41°F (5°C) to +130°F (+54°C).

Storage: -40°F (-40°C) to +200°F (93°C).

Memory: EEPROM stores data for ten years if power is lost.

Reset:

Front Panel: resets displayed values and control outputs.

Remote: 4-30 VDC positive edge, resets totalizer and control outputs.

Control Outputs:

Standard: Open collector sinks 250 mA from 30VDC when active.

Optional: 2 each Form C SPDT 5 Amp @ 120/240 VAC or 28 VDC. (Open collector outputs are also supplied with 10VDC provided at transistor outputs through relay coil. If greater than 2mA is used, relay will remain energized. Applying greater than 10 VDC may destroy unit. Transistor will sink 100mA in "ON" state.)

Input:

Standard: Linear 0-20mA, 4-20mA, 0-5V, 0-10V or 1-5V selectable from the front panel.

Optional: Square Law 0-20mA, 4-20mA, 0-5V, 0-10V, or 1-5V, is available for inputs that require square root extraction.

Input Impedance: Current: 100 Ω ; Voltage: 115K Ω

Calibration: The unit does all of the calibrations internally. There are no potentiometers to adjust and the unit never needs to be removed from the case.

Set Points: The two control set points can be set at any

number from 0 to 59999. The set point outputs can be assigned to rate or total. The unit comes standard with two open collector control outputs. Two 5 Amp, Form C relays are optional. The outputs are programmable from .01 to 599.99 sec or latched until reset when assigned to the total and a hysteresis (alarm range) when assigned to the rate.

Rate Display: Updates 5 times per second, Accurate to 4.5 digits. Set "low" greater than "high" for inverted display (LINEAR ONLY).

Totalizer: Integrates from the rate reading and accumulates up to 6 digits of total count. The time base (hours, minutes or seconds) is field programmable from the front panel.

Analog Out: The unit can be ordered with an optional 4-20mA output which is proportional to the instantaneous rate. (The normalizing averaging factor does not affect the analog output) The high and low settings are programmable from the front panel. Set "low" greater than "high" for inverted output. A sinking driver generates a corresponding linear current through the external devices. The output updates with each update of the rate. Accuracy is 50uA worst case. For rated accuracy, load must be connected to the analog output before unit is powered. Compliance voltage must be 3 to 30 VDC non inductive. (The unit can provide the DC source as long as the drop across the devices being driven does not exceed 21V).

Programming: Decimal points, Scaling from 0 to 59999 units per selected time base, set points, input type, security lock code, and assigning outputs are all programmable from the front panel.

Housing: Standard 1/8 DIN, high impact 94VO plastic case.

Shipping Weight: 2 lbs.

Overvoltage Protection:

50 V

Overcurrent Protection:

50 mA

Resolution: 14.5 Bits

Accuracy:

<u>RANGE</u>	<u>% FS ERROR</u> (worst case)	<u>% FS ERROR</u> (typical)
4-20 mA	0.1%	.05%
0-10 VDC	0.2%	0.1%
0-5 VDC	.25%	.15%
1-5 VDC	.25%	.15%

Square Law: (above 5% of bottom range) 0.1%
(5V inputs .4%) Worst case over complete range: 2%

Temperature Stability: Will not drift more than 20 parts per million per °C from 5°C to 54°C

MOUNTING

HOW TO MOUNT:

Slide the body of the unit through the rubber gasket. Insert the unit into the panel. Slide the brackets up the groove to press against the back of the panel, as shown in "FIG. A". Insert the screws into the rear of the brackets.

Tighten the screws evenly and alternately. A panel less than .1" may distort if the clamps are screwed too tightly. Do not over tighten! A normal level of torque is required. Maximum torque should be 3" pounds.

The panel must be parallel to the bezel to assure proper seal. Unit seals to NEMA 4/IP65 if properly mounted.

FIG. A

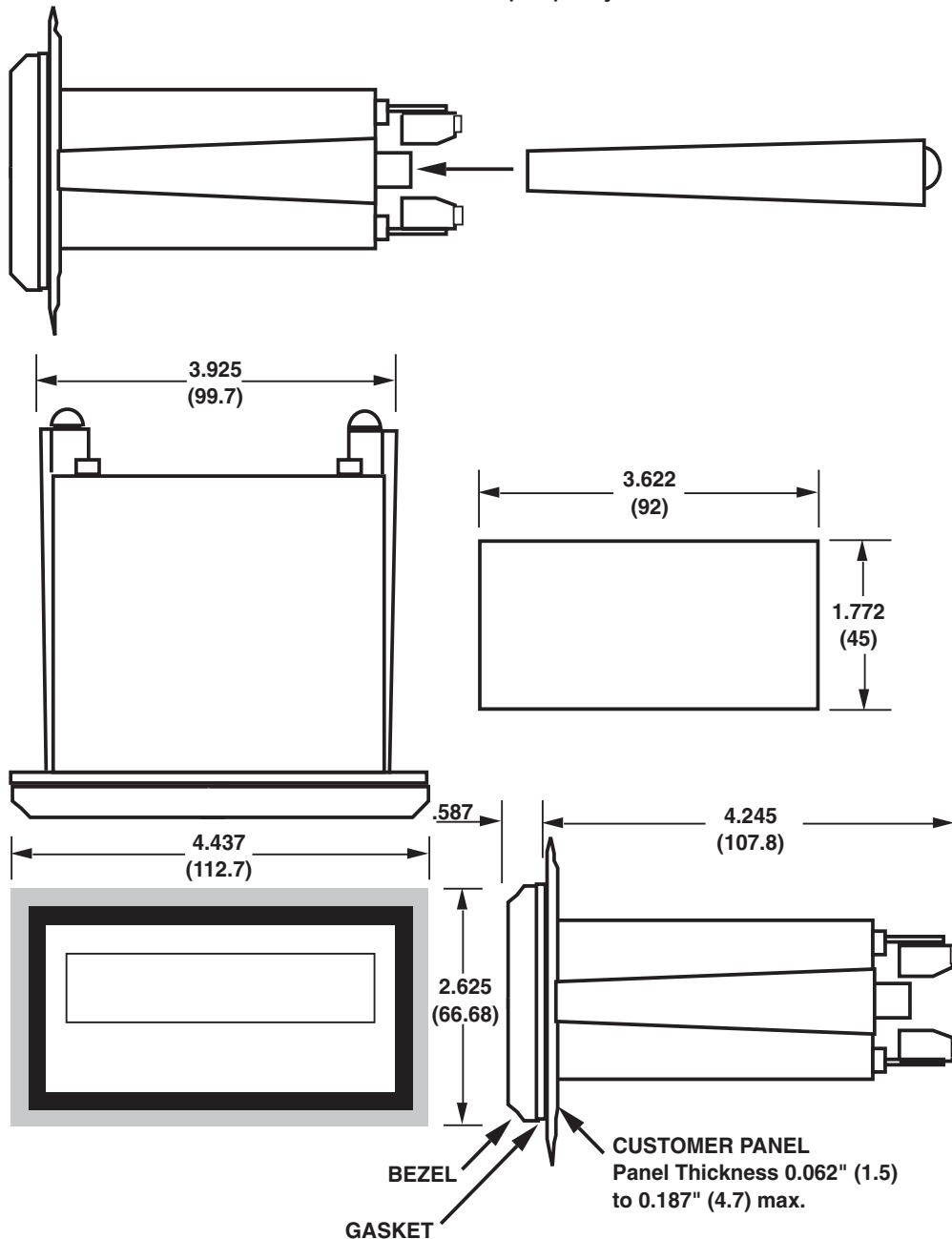



WIRING

AC / DC CONNECTIONS:

NOTE: Connect power only after other connections are finished. Do not touch the live AC power terminals. The unit has been designed with an isolated AC input, therefore polarity is not a concern for the AC power. The chassis is plastic, therefore earth ground is not used. For DC operation, connect +DC to terminal 10 and -DC to terminal 3.

This Product complies with requirements of the European Community Directive 89/336/EEC [Electromagnetic Compatibility]. However, electrical noise or intense electromagnetic fields in the vicinity of the unit may disturb the microprocessor. Users should exercise care and should take proper precautions to avoid microprocessor disturbance.

Four common sources of noise are:

1) AC power line noise- The input power lines should not be common to power lines for motors, pumps, contactors, etc. If the unit cannot be connected to an electrically clean power source, an inductive load suppressing device (MOV as GE#V130LA1 or Resistor Capacitor as Paktron# .2uf/220 ohm @ 400V) can be installed. Although locating the suppressor across the AC supply at the unit should help, best results are obtained by connecting the suppressor across the leads of the "load" at the device causing the spikes.

2) Input line noise- The noise is carried on the input and DC ground lines. Make sure the input wires are not run into the unit in a bundle with power input lines. We recommend using shielded cable. Connect the shield to DC ground of the unit and "earth" at one point in the circuit preferably at the DC ground terminal of the unit.

3) Output lines- The unit has two open collector outputs and two optional relay outputs. When these outputs are used to run external relays or solenoids, spikes can be generated upon activation. This noise can spread through the instrument causing operating problems. If the source is a D.C. operated device, a general purpose diode (IN4004) placed across the solenoid prevents electrical noise spikes. Connect the cathode (banded side) to the more positive side of the coil. If the source is an A.C. operated device, use a Resistor Capacitor or MOV across the coil.

4) 24 VDC output supply- Noise can be generated on the 24 VDC output supply if it is used to drive inductive loads or if the current draw exceeds 50mA. Insure that all inductive loads have a diode (such as IN4004) across the coil and that the current does not exceed 50mA.

NOTE: For additional over current protection the use of an external fuse is recommended on the DC output as well as Relay Output connections. It is highly recommended to use an external fuse for the power input connection (see "Typical Wiring" diagrams).

WIRING CONNECTIONS

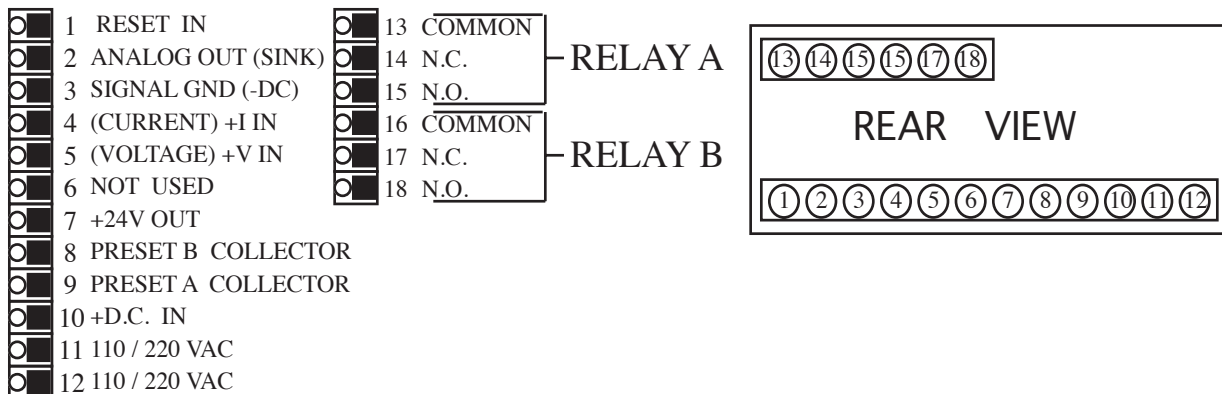

TYPICAL WIRING

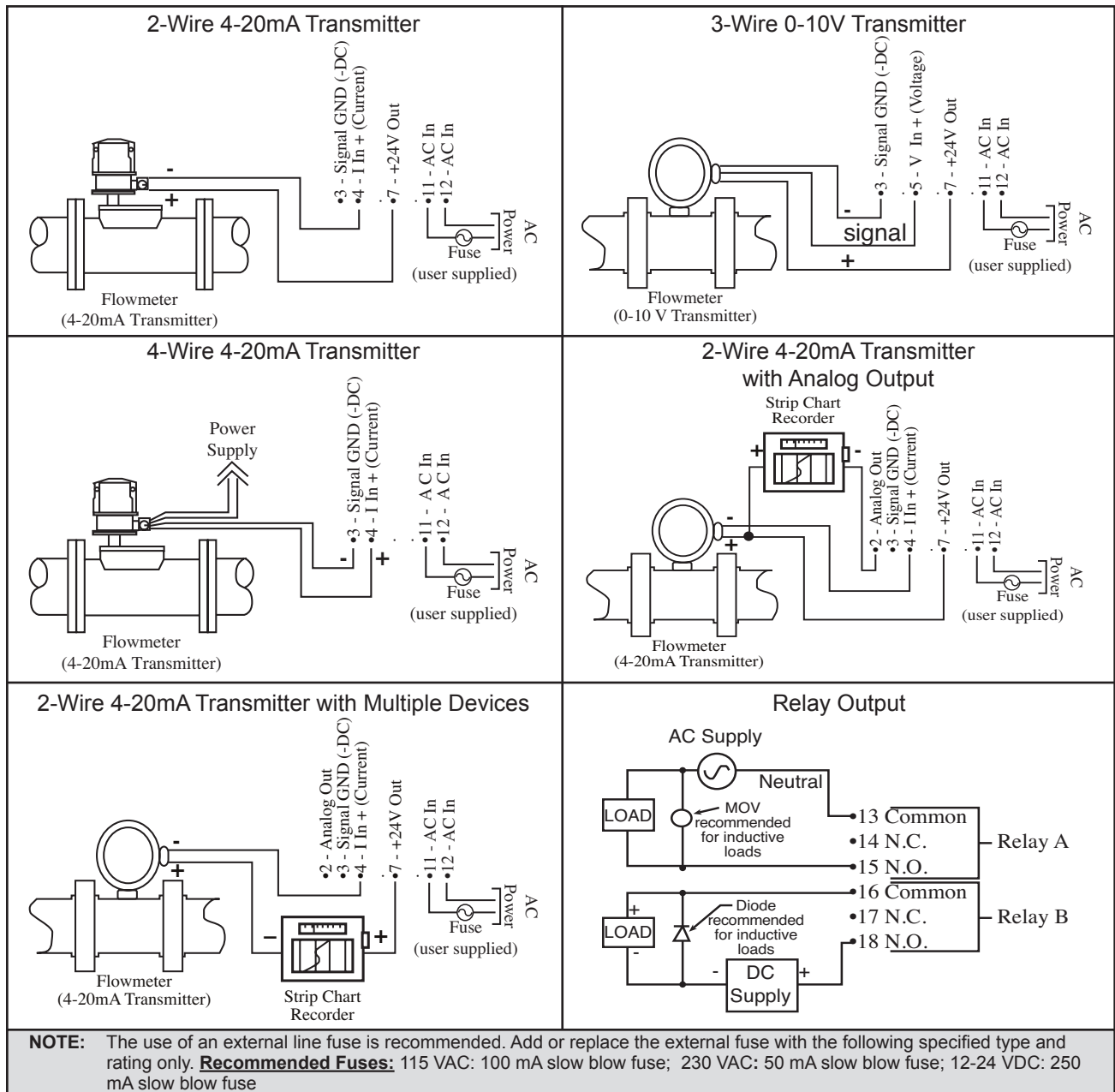

OPEN COLLECTOR & RELAY OPERATION

The open collector and relay outputs trigger when the total or rate (assignable; see programming step 2) equals or exceeds the corresponding Preset (A or B).

When the outputs are assigned to the "total", the operator can assign a duration of time (.01 to 599.99 sec.) that the output will remain energized. If 0.00 is assigned, the output will latch until reset. If output A is set at a duration (other than 0.00), the totalizer will autorecycle when Preset A is reached. At this time, output B will de-energize (if it was energized). Preset A is the final preset and should be set higher than Preset B, when both outputs are assigned to the total. If output A is set at a duration other than 0.00 and Preset A is set

less than Preset B, Preset B will be ignored (provided that they are both assigned to total). The totalizer will never autorecycle at Preset B.

When the outputs are assigned to the "rate", the outputs can be assigned a hysteresis (alarm range). The hysteresis is the number of units below the preset that the output will remain energized. EXAMPLE: Preset set @ 100; Hysteresis set @ 10. The output will energize when the rate equals 100 and de-energize when the rate falls below 90 (10 below Preset).

NOTE: If the input scaling is inverted, the control output functions are inverted (LINEAR ONLY).

V41 & V_41 PROGRAMMING FLOWCHART

NOTE:

**SEVERAL PROGRAMMING SELECTIONS WILL NOT APPEAR WITH "RATE ONLY" & "TOTAL ONLY" UNITS
OPTIONS NOT ORDERED WILL NOT APPEAR IN PROGRAM SELECTIONS**

	This symbol indicates any key.
	Press this key to step through Menu choices
	Press this key to enter displayed value.

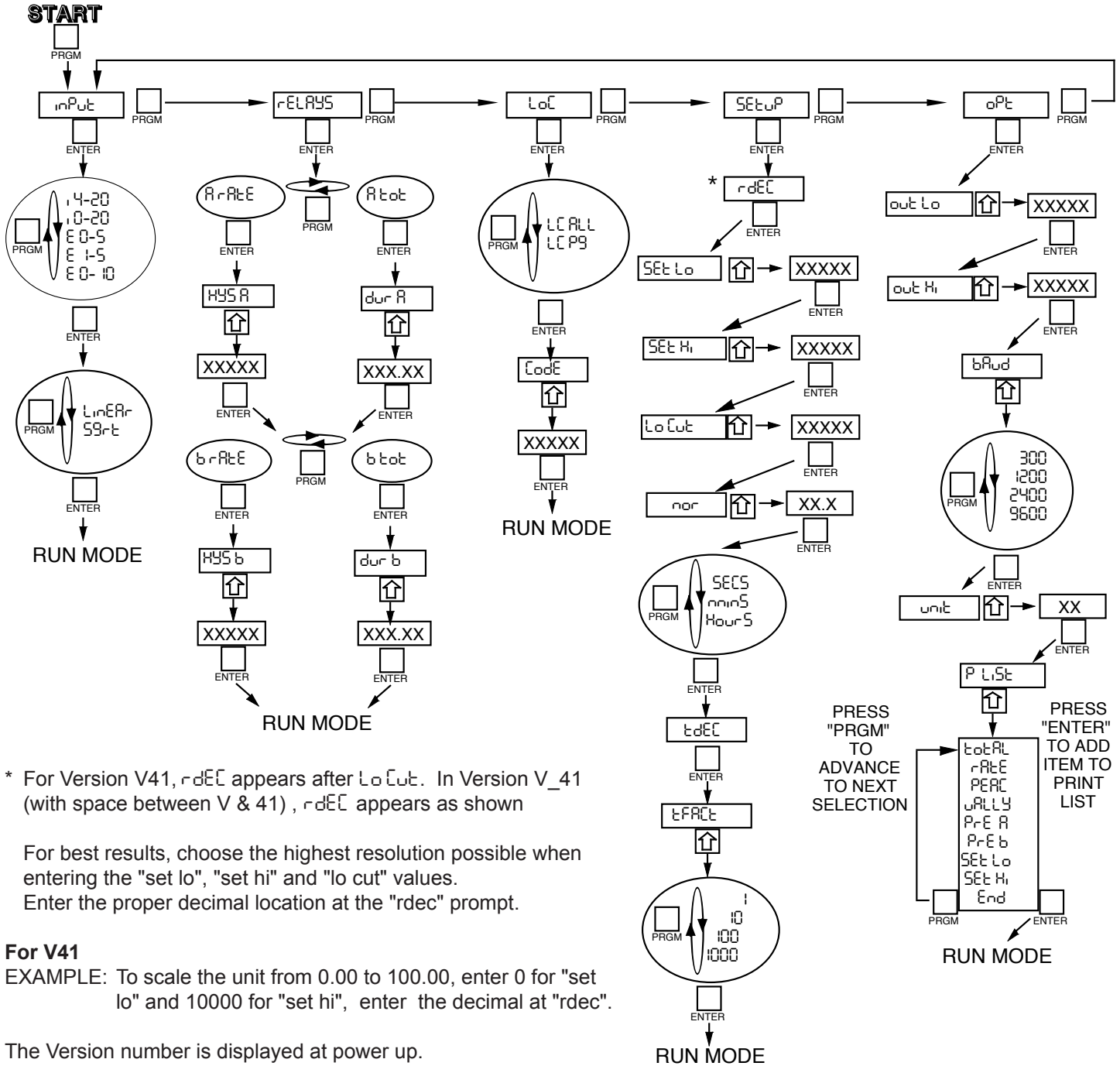

* For Version V41, r dEC appears after Lo Cut. In Version V_41 (with space between V & 41), r dEC appears as shown

For best results, choose the highest resolution possible when entering the "set lo", "set hi" and "lo cut" values.
Enter the proper decimal location at the "rdec" prompt.

For V41
EXAMPLE: To scale the unit from 0.00 to 100.00, enter 0 for "set lo" and 10000 for "set hi", enter the decimal at "rdec".

The Version number is displayed at power up.
NOTE: Model INT69T & units with RS232/RS422 option can only be used with V_41.

DEFINITIONS

inPut - INPUT; This section of the program menu assigns the type of input the unit will be using (0-20 mA, 4-20 mA, 0-5 V, 0-10 V, 1-5 V, Linear or square root extraction).

I 4-20 - I 4-20; This sets the unit for a current input of 4 to 20 mA.

I 0-20 - I 0-20; This sets the unit for a current input of 0 to 20 mA.

E 1-5 - E 1-5; This sets the unit for a voltage input of 1 to 5 volts.

E 0-5 - E 0-5; This sets the unit for a voltage input of 0 to 5 volts.

E 0- 10 - E 0-10; This sets the unit for a voltage input of 0 to 10 volts.

LinEAr - LINEAR; This sets the unit for linear input.

SQRt - SQUARE ROOT; This sets the unit for square root extraction.

rELAYS - RELAYS; This section of the program menu sets the control output variables (relays & open collector).

rATE - OUTPUT A FOR RATE; This assigns the A output to the rate.

HYS A - HYSTERESIS FOR OUTPUT A; This value is the number of units below Preset A that the output will remain "ON". EXAMPLE: Preset A set at 100, Hys set at 10. Output A will activate (turn on) when the rate equals 100; Output A will deactivate (turn off) when the rate falls below 90 (10 below Preset A)

rAtE - OUTPUT A FOR TOTAL; This assigns the A output to the totalizer.

dur A - OUTPUT A DURATION; This is the duration of time (.01 to 599.99 sec) that Output A will remain energized. If 0.00 is entered the output will latch until reset. If a value other than 0.00 is entered the unit will autorecycle at Preset A.

bRATE - OUTPUT B FOR RATE; This assigns the B output to the rate.

HYS b - HYSTERESIS FOR OUTPUT B; Same as HYS A.

bAtE - OUTPUT B FOR TOTAL; This assigns the B output to the totalizer.

dur b - OUTPUT B DURATION; This is the duration of time (.01 to 599.99 sec) that Output B will remain energized. If 0.00 is entered the output will latch until reset.

LoCk - LOCK; This section of the program menu sets up the lockout type and code.

LoCk ALl - LOCK ALL; When this is selected the lockout will lock the program as well as the Presets and reset button. The presets can be viewed but not changed.

LC P9 - LOCK PROGRAM; When this is selected the lockout will lock only the program. The Reset can be activated and the presets can be viewed and changed.

Code - CODE; This is a 5-digit code which will be used to lock and unlock the front panel.

SEtUP- SETUP; This section of the program menu sets up the operating variables.

rDEC - RATE DECIMAL LOCATION; This allows the user to program a decimal point for the rate display.

SEt Lo - SET LOW; This is the rate value for the lowest input (0 or 1 Volts; 4 mA). (i.e. 4 mA = 10 lbs/hr.)

SEt Hi - SET HIGH; This is the rate value for the highest input (5 or 10 Volts; 20 mA). (i.e. 20 mA = 500 lbs/hr.)

Lo Cut - LOW CUT-OFF; This is the lowest rate value to be recognized. All rate readings below this value will assume the "set lo" value.

nOR - NORMALIZING FACTOR; This is an averaging factor (00.0 to 99.9). Higher settings provide more normalizing (averaging) for a more stable display. Derived from the equation:
$$\frac{(\text{OLD DATA} \times \text{"NOR"} + \text{NEW DATA})}{(\text{"NOR"} + 1)}$$

SECS - SECONDS; This tells the unit that the High and Low input values are entered in units per second.

minS - MINUTES; This tells the unit that the High and Low input values are entered in units per minute.

HourS - HOURS; This tells the unit that the High and Low input values are entered in units per hours.

tDEC- TOTALIZER DECIMAL LOCATION; This allows the user to enter a decimal for the totalizer display. This decimal is not a dummy decimal and will scale the totalizer display accordingly. (i.e. if the tdec is set in the tenths position (#####.#), 100 will be displayed as 100.0)

tFRACt- TOTALIZER FACTOR; This factor divides the totalizer display by 1, 10, 100 or 1000.

oPt - OPTIONS; This section of the program menu is for setting up optional features (analog out, RS232/422 serial communications).

out Lo - OUT LOW; The displayed rate value at which the unit will output 4 mA (2 lbs./hr = 4 mA out).

out Hi - OUT HIGH; The displayed rate value at which the unit will output 20 mA (2000 lbs./hr = 20 mA out).

bRud - BAUD RATE; The baud rate at which the RS232 or RS422 communications will operate.

9600 - 9600 BAUD; This sets the communications at 9600 Baud.

2400 - 2400 BAUD; This sets the communications at 2400 Baud.

1200 - 1200 BAUD; This sets the communications at 1200 Baud.

300 - 300 BAUD; This sets the communications at 300 Baud.

UNIT - UNIT NUMBER; This assigns the unit an ID number from 1 to 99. This number is to be addressed when the unit is to be on line. A unit with 0 assigned will never come on line.

PLST - PRINT LIST; This sets a list of data that will be transmitted whenever the strobe is activated.

TOTAL - TOTAL COUNT; When this is added to the print list, the unit will transmit the total when the strobe is activated.

RATE - RATE; When this is added to the print list, the unit will transmit the present rate value when the strobe is activated.

PEAK - PEAK; When this is added to the print list, the unit will transmit the present peak value when the strobe is activated.

VALLEY - VALLEY; When this is added to the print list, the unit will transmit the present valley value when the strobe is activated.

PRE A - PRESET A; When this is added to the print list, the unit will transmit the Preset A value when the strobe is activated.

PRE B - PRESET B; When this is added to the print list, the unit will transmit the Preset B value when the strobe is activated.

SET LO - SET LOW; When this is added to the print list, the unit will transmit the Set Low value when the strobe is activated.

SET HI - SET HIGH; When this is added to the print list, the unit will transmit the Set High value when the strobe is activated.

END - END; This is the only exit from the P List. If END is not entered the unit will start at the beginning of the P List again.

PXXXXX - P; This will appear in the 6th (furthest to the left) digit when viewing the Peak. The peak value is the highest rate reading that the unit had displayed since the peak had been reset. The peak is not retained in memory when power is lost.

UXXXXX - U; This will appear in the 6th (furthest to the left) digit when viewing the Valley. The valley value is the lowest rate reading that the unit had displayed since the valley had been reset. The valley is not retained in memory when power is lost.

RXXXXX - R; This will appear in the 6th (furthest to the left) digit when viewing the Rate.

FRONT PANEL OPERATIONS

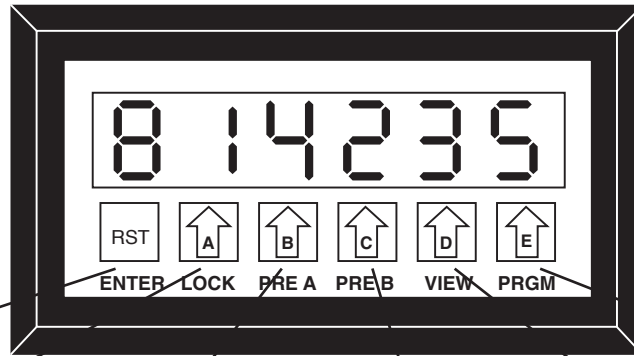

Press to RESET in operating mode; Press to "ENTER" in programming mode.

Press once to freeze display. Press any key to update display normally. Press rapidly (3 times within 5 seconds) to "enter" LOCK code for panel lock.

Press to view or change Preset A



Press to view or change Preset B

Press to alternately view Rate, Total, Peak & Valley.

Press to cycle through PROGRAM choices; Press to step through set up choices in program mode.

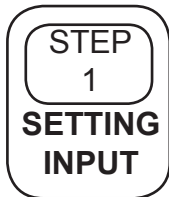







PROGRAMMING



<u>PRESS</u>	<u>DISPLAY</u>	<u>REMARKS</u>
 PRGM	inPut	This section of the menu is used to set up the type of signal the unit will be receiving.
 ENTER	, 4-20, 10-20 E 1-5, E 0-5 or E 0-10	Press the PRGM key to step through choices. Press the RST/ENTER key to enter the displayed choice.
 ENTER	LinEAr or SqrT	This section will only appear on units with the square root extraction option. Press the PRGM key to toggle between the choices and press the RST/ENTER key to enter the desired choice.

**STEP
2
SETTING
RELAYS**

NOTE: If relay outputs are not used, set **dur A** & **dur B** at "0.0" to prevent the counters from resetting at the presets.

<u>PRESS</u>	<u>DISPLAY</u>	<u>REMARKS</u>
 PRGM	inPut	This section of the menu sets up the open collector outputs and/or relays.
 PRGM	rELAYS	
 ENTER	A rAtE or A tot	Output A assigned to the rate or total. Press the PRGM key to toggle between choices, press the RST/ENTER key to enter the displayed choice.
 ENTER	(IF TOT SELECTED) dur A (hit any key to view or change existing dur A value XX.X)	dur A = the duration of time (.01 to 599.99 sec) that output A will remain on or energized. When dur A is displayed, hit any key to view or change dur A. Press the RST/ENTER key to enter displayed value. When dur A is set at 0.00, output A will latch until reset; when dur A is set other than 0.00 the counter will autorecycle at Preset A.
 ENTER	(IF RATE SELECTED) HYS A (hit any key to view or change existing HyS A value XXXXX)	Hys (hysteresis)= The number of units below the preset that the output will remain "ON". EXAMPLE: Preset set @ 100; HyS set @ 10. Output will activate (turn on) when rate = 100 and turn off when rate falls below 90 (10 below preset). Follow instructions for A RATE & A
 ENTER	b rAtE or b tot	TOT.
 ENTER	(IF TOT SELECTED) dur b	Follow instructions for dur A
 ENTER	(IF RATE SELECTED) HYS b	Follow instructions for hys A

**STEP
3
SETTING
LOCK**

PRESS

DISPLAY

REMARKS

PRGM

PRGM

PRGM

inPut
rELAYS
LoC

This section of the menu is used to set up the lockout type and code.

ENTER

LC PG or LC ALL

LC PG = Locks program but presets are accessible.
LC ALL= Locks program & presets. Press the PRGM button to toggle between choices; Press RST/ENTER to enter displayed choice.

ENTER

CoDE
Press any key to view or change the lock code

When CODE is displayed, press any key to view existing lock code. To change the code press the key under each digit to be changed. Press RST/ENTER to enter displayed value.

**STEP
4
SETTING
SETUP**

PRGM

PRGM

PRGM

PRGM

inPut
rELAYS
LoC
SEtUP

This section of the menu is used to set up important operating variables.

ENTER

rDEC

RDEC= rate decimal location; Press the key under the digit with the desired location. Press the "E" key if a decimal is not desired. Press RST/ENTER to enter the displayed location.

ENTER

SEt Lo
Press any key to view or change existing value

SET LO= Rate value for the lowest input (0 or 1V; 4mA).(i.e. 4mA = 10 lbs/hr.) Key in the desired low value and press RST/ENTER to enter displayed value.

ENTER









SEt Hi
Press any key to view or change existing value

SET HI= Rate value for the highest input (5 or 10V; 20mA).(i.e. 20mA = 500 lbs/hr.). Key in the desired high value and press RST/ENTER to enter displayed value.











CONTINUED ON NEXT PAGE

STEP
4
CONT...

**SETTING
SETUP**





<u>PRESS</u>	<u>DISPLAY</u>	<u>REMARKS</u>
 ENTER	Lo Cut Press any key to view or change existing value	LO CUT= Low cut-off; Lowest rate value to be recognized. All rate readings below the "cutoff" will assume the "set lo" value. Key in the desired value and press RST/ENTER to enter displayed value.
 ENTER	nor Press any key to view or change existing value	NOR= Normalizing (averaging) factor (00.0 to 99.9); Key in the desired value and press RST/ENTER to enter displayed value. Higher settings provide more normalizing (averaging) for a more stable display.
 PRGM  ENTER	minS, HourS or SECS	This section tells the unit that the high & low setting are entered in units per Minutes, Hours or Seconds. Press the PRGM key to step through choices. Press RST/ENTER to enter displayed choice.
 ENTER	tDEC	TDEC= Totalizer Decimal; Press the arrow keys to enter in the desired totalizer decimal. Press RST/ENTER to enter displayed choice. Entering a decimal will add resolution to the total. (i.e. tdec=#####.#; 100 will be displayed as 100.0)
 ENTER	tFACT Press any key to view or change existing value	TFACT= Totalizer Factor; This factor allows you to divide the totalizer by 1, 10, 100, 1000
 PRGM  ENTER	1, 10, 100 or 1000	Press the PRGM key to step to the desired factor. Press RST/ENTER to enter displayed choice.

STEP
5
SETTING
OPTIONS

<u>PRESS</u>	<u>DISPLAY</u>	<u>REMARKS</u>	
 PRGM	inPut		
 PRGM	rELAYS		
 PRGM	LoC		
 PRGM	SEtUP	This section of the menu is for setting up the variables for any options which were ordered (Analog out or Serial communications).	
 PRGM	oPt		
 ENTER	out Lo Press any key to view or change existing value		OUT LO= The rate value represented by the 4 mA end of the 4-20 mA output Key in the desired value and press RST/ ENTER to enter displayed value.
 ENTER	out Hi Press any key to view or change existing value		OUT HI= The rate value represented by the 20 mA end of the 4-20 mA output. Key in the desired value and press RST/ ENTER to enter displayed value.
 ENTER	bAud Press any key to view or change existing value 9600, 1200, 2400 or 300		BAUD = Baud rate for RS 232 or RS 422 communications option. Press any key to view existing value. Press the PRGM key to view available baud rates; Press RST/ENTER to enter displayed value.
 ENTER	unit Press any key to view or change existing value		UNIT = Unit ID number. Key in the desired unit number (1-99) and press RST/ENTER to enter displayed value.
 OR 	P LIST Press any key to enter print list toTAL rATE PEAK vALLY PrE A PrE B SEt Lo SEt Hi End	P LIST = Print list. Press RST/ENTER to add items to list; Press PRGM to remove items from list. TOTAL = Total RATE = Rate PEAK = Peak UALLY = Valley PRE A = Preset A PRE B = Preset B SET LO = Low Input Value SET HI = High Input Value END = Press RST/ENTER to exit (end) print list; Press PRGM to recycle through list choices.	

THE PROGRAM SETUP IS COMPLETE! YOU ARE NOW READY TO SET THE PRESETS.

SETTING THE PRESETS & PANEL LOCK

	<u>PRESS</u>	<u>DISPLAY</u>	<u>REMARKS</u>
<div style="border: 1px solid black; border-radius: 15px; padding: 10px; width: fit-content;"> <p style="text-align: center; margin: 0;">SETTING THE PRESETS</p> </div>	 PRE A	PRE A Press any key to view or change existing value	PRE A = Preset A (Final Preset); The set point at which output A will trigger. If the displayed value is not the desired preset, press the key(s) under the digit to be changed.
	 PRE B	PRE B Press any key to view or change existing value	PRE B = Preset B (Prewarn); The set point at which output B will trigger. If the displayed value is not the desired preset, press the key(s) under the digit to be changed.
<p>NOTE: Presets can be set at any value form 0 to 59999.</p>			
<div style="border: 1px solid black; border-radius: 15px; padding: 10px; width: fit-content;"> <p style="text-align: center; margin: 0;">SETTING THE LOCK STATUS</p> </div>		LOCK Press any key to enter the 5-digit lock code.	Key in the lock code (see programming step 3) by pressing the keys under the digits to be changed. Each time a key is pressed the digit will increment one. Press the RST/ENTER key to enter the displayed code.
	<p>Press LOCK 3 times within 5 seconds (If LOCK is pressed once, unit freezes display)</p>	 ENTER	LOC or UNLOC

RS 232/422 OPERATIONS

This section applies to units which have the serial communications interface option. Up to 99 units can be linked together. Unit status can be accessed and many menu items can be entered through the serial port. Data is transmitted at selected baud rates using standard eight bit ASCII characters and one "stop" bit. The unit does not check or transmit a parity bit.

UNIT I.D. (DEVICE #)

Each unit in the hookup must be assigned a unit number from 1 to 99. This can be entered through the front panel (see step 5 of the programming section). If "00" is assigned, the unit can not be brought on line through the serial port. The units will remain in an "off" high impedance state until addressed by the assigned unit number. Once a unit is addressed, do not address another unit until the data has been sent and any data requested has been transmitted back.

BAUD RATE

The baud rate is the speed at which data is transmitted, expressed in bits per second. Baud rates of 300, 1200, 2400 or 9600 are available. Select the desired baud rate from the menu. (see step 5 of the programming section).

PRINT LIST

The serial interface card is equipped with a strobe line. When the strobe line is activated a user selectable set of data (print list) is transmitted. This transmission can be sent to a computer or printer. The print list consists of eight selectable items: COUNT, RATE, PEAK, VALLEY, PRE A, PRE B, LOW SET, HIGH SET. The list can be entered through the front panel (see step 5 of the programming section) or through the serial port (read on).

HELP

A help command has been installed for easy access of the command and data variables. When help is needed, type a "?" and press return (enter) whenever a unit is on line. The following list will be transmitted:

D#XX:

S Set
E Exam
R Reset
G Lock
L*List
C*Count
R*Rate
P*Peak
V*Valley
A*PreA
B*PreB
L*Lo Set
H*Hi Set
J Lo Out
K Hi Out
N Norm
D Unit
E Input
G Hy/DrA
I Hy/DrB
M Time
T Baud
W Lock
X Meter
Y A Typ
Z B Typ
O Code
F RDec
Q TDec
U TFact

The unit transmits the unit ID (D#XX) as well as the variables for the corresponding commands and data. A "*" indicates that the data is available for the print list.

COMMANDS:

Each command consists of an instruction and an address. Each instruction and address is represented by a letter. The prefix of each command must be an instruction followed by an address (and address variable if applicable).

INSTRUCTIONS (1st letter of command):

[S] Set - Used to set the value or operating parameter of an address. (i.e. "SC 5000" will set the count at 5000)

[E] Examine - Used to examine the value or status of an address. (i.e. "ER" will examine the present rate reading)

[R] Reset - Used to reset the count & control output, peak or valley. (i.e. "RP" will reset the peak value)

[G] Lock - used to lock and unlock the unit. Type "G" followed by the "lock code" to lock and unlock the unit.

[L]*List - Used to set the print list. (i.e. "LCRVA" will set the list for count, rate, valley and preset A. These values will be transmitted whenever the strobe is activated.)

ADDRESSES (2nd letter of command):

[C]*Count
[R]*Rate
[P]*Peak
[V]*Valley
[A]*PreA
[B]*PreB
[L]*Lo Set
[H]*Hi Set
[J] Lo Out
[K] Hi Out
[N] Norm
[D] Unit
[E] Input
[G] Dur A
[I] Dur B
[M] Time
[T] Baud
[W] Lock
[X] Meter
[Y] A Type
[Z] B Type
[O] Code
[F] RDec
[Q] TDec
[U] TFact

POSSIBLE COMMANDS:

Each command must be followed by a carriage return for execution.

DXX: (device "unit ID" #-) Unit XX will come "on line" and stay "on line" until another device is addressed.

SD XX: (set device "unit ID" #-) sets unit ID # at requested value

ED: (examine device)- Unit will transmit the present device (unit ID) number (i.e. d = 000000XX).

SC XXXXXX: (set count)- Sets count at requested value.

EC: (examine count)- Unit will transmit the present count value (i.e. c=00XXXXXX).

RC: (reset count)- Resets the counter and control output .

ER: (examine rate)- Unit will transmit the present rate value (i.e. r= 000XXXXX).

RR: (reset rate)- Resets the normalization

EP: (examine peak)- Unit will transmit the present peak value (i.e. p= 000XXXXX).

RP: (reset peak)- Unit will reset the peak.

EV: (examine valley)- Unit will transmit the present valley value (i.e. v=000XXXXX).

RV: (reset valley)- Resets the valley.

SA XXXXX: (set preset A)- Sets preset A at requested value.

EA: (examine preset A)- Unit will transmit present preset A value (i.e. a=000XXXXX).

SB XXXXX: (set preset B)- Sets preset B at requested value.

EB: (examine B)- Unit will transmit present preset B value (i.e. b = 000XXXXX).

SL XXXXX: (set "Low")- Sets "set low" at requested value.

EL: (examine "Low")- Unit will transmit present "set low" value (i.e. l = 000XXXXX).

SH XXXXX: (set "High")- Sets "set high" at requested value.

EH: (examine "High")- Unit will transmit present "set high" value. (i.e. h = 000XXXXX)

SJ XXXXX: (set "low out")- Sets "out low" at requested value. Only available with ANA-LOG OUT option.

EJ: (examine "low out")- Unit will transmit present "out low" value. (i.e. j = 000XXXXX)

SK XXXXX: (set "high out")- Sets "out high" at requested value. Only available with ANA-LOG OUT option

EK: (examine "high out")- Unit will transmit present "out high" value. (i.e. k = 000XXXXX)

SN XX.X: (set norm)- Sets "norm" at requested value. Must be a 3-digit number with decimal.

EN: (examine norm)- Unit will transmit present "norm" value (i.e. n = 000XX.X).

SE i 4-20, i 0-20, e 0-5, e 1-5 or e 0-10: (set input)- sets input to one of the 4 available types. Enter type exactly as it appears on the display.

EE: (examine input)- Unit will transmit input type (i.e. e 0-10).

SG XXXXX: (set dur A or hys A)- Sets dur A or hys A at requested value. (dur A when A is assigned to total; hys A when A assigned to rate).

EG: (examine dur A or hys A)- Unit will transmit present dur A or hys A value (i.e.g = 000XXXXX)

SI XXXXX: (set dur B or hys B)- Sets dur B or hys B at requested value. (dur B when B is assigned to total; hys B when B assigned to rate).

EI: (examine dur B or hys B)- Unit will transmit present dur B or hys B value (i.e.l = 000XXXXX)

SM secs, mins or hours: (set time base)- Sets time base to desired setting.

EM: (examine time base)- Unit will transmit present time base (i.e. secs).

ST XXXX: (set baud)- Sets baud at desired rate (9600, 2400, 1200 or 300).

ET: (examine baud)- Unit will transmit present baud rate (i.e. 9600).

EW: (examine lock type)- unit will transmit present lock type (i.e. lc pg).

SX linear or sqrt: (set meter type)- Sets meter input for linear or square root extraction. Only available with square law option.

EX: (examine meter type)- Unit will transmit present meter type (i.e. linear).

SY A tot or A rate: (set A type)- Assigns control output A to rate or total.

EY: (examine A type)- Unit will transmit present A type (i.e. a tot).

SZ B tot or B rate: (set B type)- Assigns control output B to rate or total.

EZ: (examine B type)- Unit will transmit present B type (i.e. b tot).

- SO XXXXX:** (set lock code)- Sets lock code at requested value.
- EO:** (examine code)- Unit will transmit present code (i.e. o=000XXXXX).
- SFX:** (set rate decimal location)- Sets rate decimal at requested location (0 to 4).
- EF:** (examine rate decimal location)- Unit will transmit the present rate decimal location (i.e. f = 0000000X).
- G XXXXXX:** (lock unit)- Locks and unlocks unit. (XXXXX = code)
- SQX:** (set totalizer decimal location)- Sets totalizer decimal at requested location (0 to 4)
- EQ:** (examine totalizer decimal location)- Unit will transmit present total decimal location (i.e. Q = 0000000X).
- SU XXXX:** (set totalizer scale factor)- Sets totalizer scale factor at requested value. This factor divides the totalizer by 1, 10, 100 or 1000. (i.e. SUXXX100 sets the divider at 100 where "X" represents the required space characters.
- EU:** (examine totalizer scale factor)- Unit will transmit present total scale factor (i.e. U = XXX100 where "X" represents the space characters).
- L CRPVABLH:** (list)- The list can consist of any combination of the eight available options. Any address with a "*" next to it can be listed.

SERIAL INTERFACE OPERATION:

Data is received and transmitted over standard EIA RS232 or RS422 levels. Each ten bit character is made up of a start bit, eight bit ASCII code and a stop bit.

The input impedance of RS232 is 3K Ω to 7K Ω worst case. The terminal addressing the unit must be capable of driving all loads in the loop. The input impedance of RS422 is much higher and there should be no problem driving as many as 99 units. The transmit line remains in a high impedance "off" state until addressed. Only one unit is to be on line at a time!!! More than one unit on line could damage the unit or destroy the transmitted data.

When the unit is active (on line) it will operate in an echo back mode so that data sent from the terminal will be transmitted back for verification. When the unit is "on line", use the proper serial transmit commands to request data or set a new value. Be sure to send only one command at a time followed by a carriage return to insure proper operation. If an error is made, a correction can be made by back spacing and retyping correct data before the return (enter) is sent. Once a return (enter) is sent, the unit begins processing the data and will transmit the requested data on a non-priority basis over the data transmit line. The unit will not transmit data if the Printer Busy line is activated (high). When the Printer Busy line is activated all transmissions are halted until the line goes low or open. There should be a pause after data is requested to insure that all data has been transmitted before making another request or addressing another unit. If transmission has not started within two seconds after data is requested, it can be assumed that there is a problem. The unit transmits a carriage return and line feed after each data value. The unit will stay "on line" until another unit is addressed.

RS232/RS422 - PC INTERFACE:

The following BASIC program is for setting up RS232/RS422 on serial port (#1) at 300 baud. Run this program after connecting the serial interface connections.

```

10 SCREEN 0,0:WIDTH 80
20 CLS:CLOSE
30 OPEN "COM1:300,n,8,1,CS,DS,CD" AS #1
40 ON ERROR GOTO 110
50 B$=INKEY$
60 IF B$< >" THEN PRINT #1,B$;
70 IF EOF (1) THEN 50
80 A$=INPUT$ (LOC(1),#1)
90 PRINT A$;
100 GOTO 50
110 RESUME

```



RS232 / RS422 WIRING

COMPUTER HOOKUP:

RS 232: When connecting the unit to a computer with RS 232 communication, only three connections are needed. These connections are: Receive data, Transmit data and Ground. The connections should be made as follows:

DB-9 CONNECTOR COMPUTER

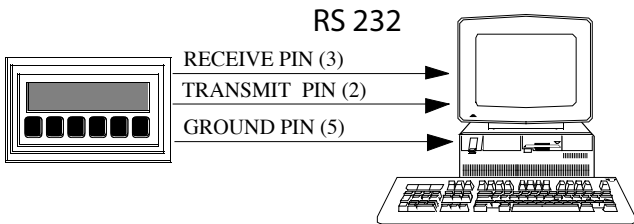
Transmit data (pin 2)	Receive data
Receive data (pin 3)	Transmit data
Ground (pin 5)	Ground



RS 422: When connecting the unit to a computer with RS 422, five connections are needed. These connections are: Receive data A (+), Receive data B (-), Transmit data A (+), Transmit data B (-) and Ground. The connections should be made as follows:

DB-9 CONNECTOR COMPUTER

Trans. data A(+) (pin 2)	Rec. data A(+)
Trans. data B(-) (pin 7)	Rec. data B(-)
Rec. data A(+) (pin 3)	Trans. data A(+)
Rec. data B(-) (pin 8)	Trans. data B(-)
Ground (pin 5)	Ground

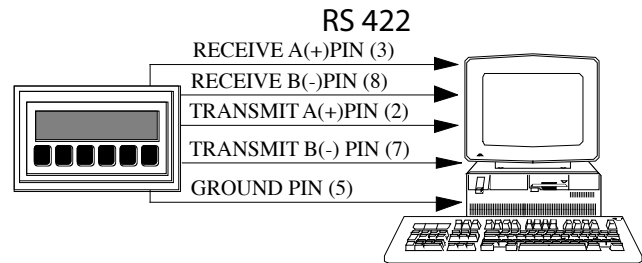

PRINTER HOOKUP:

When connecting the unit to a printer, you must first program the desired baud rate, parity and strobe list with a computer. After the unit is programmed it can be connected to the printer. Connect the transmit line(s) of the unit to the receive line(s) of the printer and be sure that both devices have common grounds. When the strobe line is triggered the unit will transmit the selected strobe list which you had previously programmed.

RS 422

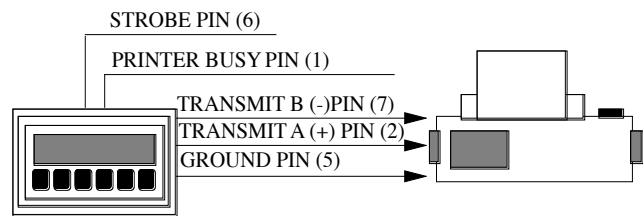

RS 232

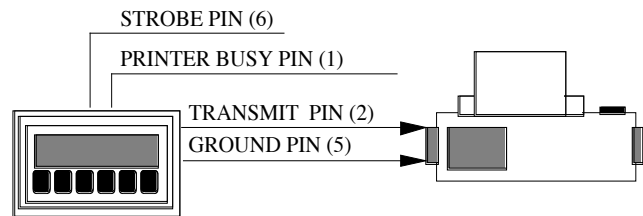

DB - 9 CONNECTOR

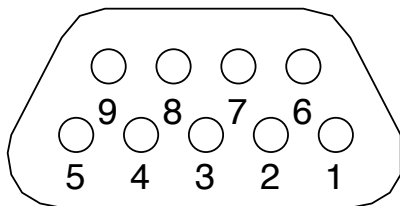

- 1- Printer busy: 3 to 30 VDC, Level activated.
- 2- Transmit A(+) (RS422); Transmit (RS232)
- 3- Receive A(+) (RS422); Receive (RS232)
- 4- Not Used
- 5- Ground
- 6- Strobe: 3 to 30 VDC Positive Edge
- 7- Transmit B(-) (RS422 Only)
- 8- Receive B(-) (RS422 Only)
- 9- Not Used

TROUBLESHOOTING GUIDE

PROBLEM	POSSIBLE CAUSES	SOLUTIONS
Power is applied to unit but the display does not light.	1. AC or DC power wiring is incorrect.	1. Recheck power wiring.
Unit works but occasionally the display freezes or skips counts.	1. Line noise is effecting the processor due to a current spike or surge.	1. Use a different power supply or install a surge suppressor.
Input signal is connected but the unit does not totalize or rate.	1. Input wiring is incorrect 2. High and low scaling settings are incorrect. 3. Transmitting device is defective. 4. Unit is defective.	1. Recheck input wiring. 2. Recheck high and low scaling settings. 3. Replace transmitting device. 4. To confirm set meter for 0-10V input, low @ 0; high @ 10. Apply a 0-10V signal to the voltage input (pin 5). When viewing the rate the meter should display the voltage value that is applied. If not call factory for an RMA#.
Display reading is inaccurate.	1. Input wiring is incorrect.	1. Be sure that voltage signals are connected to voltage input (pin 5) and current signals are connected to current input (pin 4).
Ratemeter works properly but totalizer is incorrect.	1. Time base is incorrect.	1. Recheck time base setting in setup section of the program menu.

IF YOU HAVE ANY OTHER PROBLEMS, PLEASE CALL THE FACTORY.

We hope you will be pleased with our product. If you have any questions concerning our warranty, repair, modification or returned goods process, please contact your local distributor.

WARRANTY

This product is warranted against defects in materials and workmanship for a period of two (2) years from the date of shipment to Buyer.

The Warranty is limited to repair or replacment of the defective unit at the option of the manufacturer. This warranty is void if the product has been altered, misused, dismantled, or otherwise abused.

ALL OTHER WARRANTIES, EXPRESSED OR IMPLIED, ARE EXCLUDED, INCLUDING BUT NOT LIMITED TO THE IMPLIED WARRANTIES OF MERCHANTABILITY AND FITNESS FOR A PARTICULAR PURPOSE.

Kessler - Ellis Products Co.
10 Industrial Way East
Eatontown, NJ 07724
(732) 935- 1320
Toll Free 800 - 631 - 2165
Fax (732) - 935- 9344

DECODING PART NUMBER

SAMPLE: INT69RT A L 1 C1

Series					
INT69RT= Ratemeter / Totalizer INT69R= Ratemeter Only INT69T= Totalizer Only					
Operating Voltage					
A= 110 VAC ± 15% or 12 to 24 VDC B= 220 VAC ± 15% or 12 to 24 VDC					
Inputs					
L= Linear (standard) S= Square Law (optional)					
Control outputs					
1= 2 - Open Collector Outputs (standard) 2= 2 - 5 Amp Form C Relays (optional)					
Options					
A= Analog Output (4-20 mA) C1= RS 232 communications C2= RS 422 communications					

Accessories
 Separate non keyboard panel order # 34235
 Separate keyboard panel order # 34237

Revision History

<u>Revision</u>	<u>Changes</u>
01/05/05	Original
01/27/10	PG5: Added notes regarding use of an external fuse for power input wiring PG4: Added a note regarding the use of an external fuse for the DC Output and Relay Outputs

KEP

LEADERS IN INDUSTRIAL AUTOMATION TECHNOLOGY

For more than 40 years, Kessler Ellis Products has been supplying industrial automation and flow instrumentation products to a broad range of customers worldwide.

KEP offers automation solutions ranging from simple voltage meters to sophisticated flow computers and HMI software. We also offer Operator Interface Panels that can be interfaced to PLC Controllers, KEP flow instruments and KEP Marine Displays.

Our commitment to providing next-generation solutions has allowed us to push existing performance levels into more rugged, reliable and convenient packages. But more importantly, our emphasis on product quality and customer service has helped us gain the trust and confidence of our customers around the world.



FLOW MEASUREMENT

KEP seeks to service the flow measurement community by providing versatile, economical instrumentation and "know how" to our users. Our flow measurement products include: field indicators, ratemeter/totalizers, batchers, process & level indicators and sophisticated flow computers. We offer advanced communication features such as: RS-232, RS-485 with Modbus RTU protocol, Modem, Modbus TCP and Wireless support. We are experts in interfacing with all types of primary flow sensors. We assist users by providing economical solutions for their instrumentation needs.



COUNT/RATE MEASUREMENT

Need local count values? Try our full line of high speed, rugged counters, rate monitors and sensors. They are perfect for discrete parts production counting, or measuring motor RPM or conveyor speed. Easy to program, easy to use, and EASY TO SEE!!



OPERATOR INTERFACES

PLC's are great, but how does an operator interact with the PLC? Our MMI series of text interfaces and graphical touchscreens connect to nearly all PLC's and easily let the user view the process and change setup information. We also offer simple BCD to LED displays and BCD thumbwheel and rotary input switches.

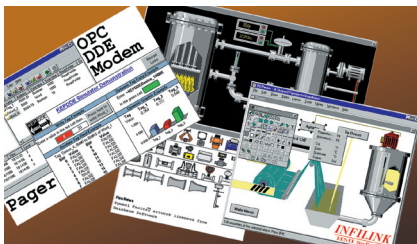

HMI SOFTWARE AND COMMUNICATION

Infilink-HMI is a full featured operator interface package, is an OPC client, and includes trending and datalogging. The development package is free. And a free OPC Server is included which connects using nearly any communication protocol over RS232, RS485, Ethernet, or other hardware layers.

KEP
www.kep.com