

# FT430/440/450

Rate/Total Indicator  
Instructions



Optional Protective Cover Closed



**General Information**

General Information .....Page 3  
 Specifications .....Page 3  
 Features .....Page 4  
 Pulse Output Functions.....Page 4

**Installation**

Wall Mount.....Page 5  
 Meter Mount .....Page 5  
 Panel Mount .....Page 5

**Connection Diagrams**

FT450 Standard.....Page 6  
 FT430/3-Wire Mechanical Meter.....Page 6  
 Connections for FT430-139 or FT440-139—115Vac Option .....Page 7  
 FT440/3-wire Mechanical/Dual Scaled Pulse Output.....Page 7  
 FT440/EX Magmeter.....Page 8  
 FT440-139/EX Magmeter .....Page 8

**Settings**

K-Factor .....Page 9  
 Changing Flow Indicator Settings.....Page 9  
 Menu Navigation.....Page 9  
 FT440 Secondary Menu Functions .....Page 11

**Troubleshooting**

Problems .....Back  
 Probable Causes.....Back  
 Things to Try.....Back

The **FT430/440/450** flow computers are microcontroller-based indicator/transmitters that interface with pulse output flow sensors to compute and display flow rate, flow total, and also generate output signals representing flow. The FT430 and FT450 have one scaled pulse output and one pulse pass through. The FT440 has two scaled pulse outputs. Galvanic isolation is provided for most pulse outputs.

The FT450 is battery powered while the FT430 may be powered by an external DC power source or an optional internal AC power supply\*. The FT440 is a "two-wire" or "loop powered" device, meaning that it is powered by the 4-20 mA loop circuit itself. An optional internal AC power supply\* is available for the FT440 with dual 24 and 12VDC outputs to power both the loop and sensors requiring more power than the loop can supply.

Pulse and 4-20mA analog outputs can be used to signal external devices, e.g. certain metering pumps and water treatment controls. Alternatively, one or more pulse outputs can be configured as alarm outputs. These flow computers can be password protected to prevent resetting the total or changing configuration settings.

The FT430/440/450 meters are available in wall and meter mount configurations. The FT430 and FT440 models can also be panel mounted. Some configurations can be converted from wall to meter or meter to wall after installation if needed. Consult factory for details.

Order the FT440 only if a 4-20mA output signal is a requirement and the FT450 if internal battery power is needed. Otherwise the FT430 offers the most flexibility.

*\*Internal power supply is available for the wall mount option only.*

**Specifications\***

	<b>FT430</b>	<b>FT440</b>	<b>FT450</b>
<b>Power</b>	7-30Vdc, 4mA	7-30Vdc, 4mA (4-20 mA when loop-powered)	Lithium "C", 3.6Vdc, replaceable. Life is ~5 years depending on usage.
<b>Display</b>	<b>Rate</b>	5-digit autorange	5-digit autorange
	<b>Total</b>	8-digit	8-digit
<b>Units</b>	<b>Rate Units</b>	Gallons/Second/Minute/Hour/Day, Liter/Second/Minute/Hour/Day, Cubic Feet/Second/Minute/Hour/Day, Cubic Meters/Second/Minute/Hour/Day, Miner's Inch, Mega Liters/Day, Million Gallons/Day, Fluid Oz/Second/Minute/Hour/Day	
	<b>Total Units</b>	Gallon, Gallon x 1000, Liters, Mega Liter, Cubic Meter, Acre Feet, Cubic Feet, Cubic Feet x 1000, Million Gallon, Miner's Inch Day, Acre Inch, Fluid Ounce	
<b>Outputs</b>	<b>Pulse Output 1</b>	Scaled pulse output, high alarm output or low alarm output. Optoisolated on FT430 and FT440. <sup>1</sup>	
	<b>Pulse Output 2</b>	Pulse pass through	Scaled pulse output, high alarm output or low alarm output. <sup>1</sup>
	<b>Loop Power Output</b>	N/A	4-20mA Loop
<b>Set P Range</b>	0.1 - 99999.9 units/pulse	0.1 - 99999.9 units/pulse	0.1 - 99999.9 units/pulse
<b>Input</b>	5V pulse or contact closure	5V pulse or contact closure	Micropower GMR Sensor (square wave)
<b>Input Range</b>	0.75 <sup>2</sup> - 2000Hz	0.75 <sup>2</sup> - 2000Hz	0.75 <sup>2</sup> - 550Hz
<b>K-Factor Range</b>	.001 - 999999.999	.001 - 999999.999	.001 - 999999.999
<b>Flow Alarm Output Range</b>	0.1 - 99999.9	0.1 - 99999.9	0.1 - 99999.9
<b>Operating Temperature</b>	0° to 55° C (-32° to 131° F)	0° to 55° C (-32° to 131° F)	0° to 55° C (-32° to 131° F)
<b>Non-Operating Temperature</b>	-40° to 75° C (-40° to 158° F)	-40° to 75° C (-40° to 158° F)	-40° to 75° C (-40° to 158° F)
<b>Environmental</b>	NEMA 4X, IP67	NEMA 4X, IP67	NEMA 4X, IP67
<b>Regulatory</b>	CE Mark	CE Mark	CE Mark

\* Specifications subject to change • Please consult our website for current data ([www.seametrics.com](http://www.seametrics.com)).

1 Scaled output pulses have a fixed width of 100ms. Maximum pulses per second is 6.5Hz

2 For pulse frequencies <1 Hz, increase setting in SET F menu to 3 or higher.

Features



\* Includes password protection for tamper prevention when needed

Pulse Output Function Table

PULSE OUTPUT 1 (SCALED)	FT430	FT440	FT450
TYPE	Current sinking	Current sinking	Current sinking
MAX. VOLTAGE	45 Vdc	45 Vdc	3.6 V
MAX. CURRENT	100 mA	100 mA	100 mA
MAX. FREQUENCY	6.5 Hz	6.5 Hz	6.5 Hz
PULSE WIDTH	100 ms	100 ms	100 ms
ISOLATION	300 V	300 V	NOTE 1
CONFIGURABLE AS ALARM	YES (High or Low)	YES (High or Low)	YES (High or Low)
PULSE OUTPUT 2 (SCALED)	FT430	FT440 (Note 2)	FT450
TYPE	Not Available	Current sinking	Not Available
MAX. VOLTAGE		45 Vdc	
MAX. CURRENT		100 mA	
MAX. FREQUENCY		6.5 Hz	
PULSE WIDTH		100 ms	
ISOLATION		300 V	
CONFIGURABLE AS ALARM		YES (High or Low)	
PULSE OUTPUT 2 (PASS-THROUGH)	FT430	FT440	FT450
TYPE	Current sinking	Not Available	Current sinking
MAX. VOLTAGE	45 Vdc		3.6 V
MAX. CURRENT	10 mA		100 mA
MAX. FREQUENCY	2000 Hz <sup>NOTE 2</sup>		550 Hz
PULSE WIDTH	SAME AS SENSOR INPUT		SAME AS SENSOR INPUT
ISOLATION	300 V		NOTE 1
CONFIGURABLE AS ALARM	NO		NO

NOTE 1: 150 V effective isolation when using Seametrics micropower sensors. • NOTE 2: With 2000 ohm or lower pull-up resistance.

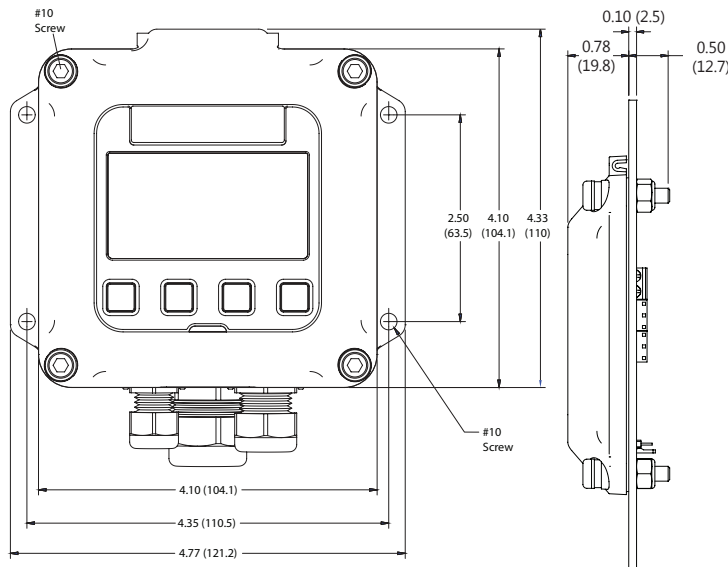

Dimensions are in Inches (Millimeters)

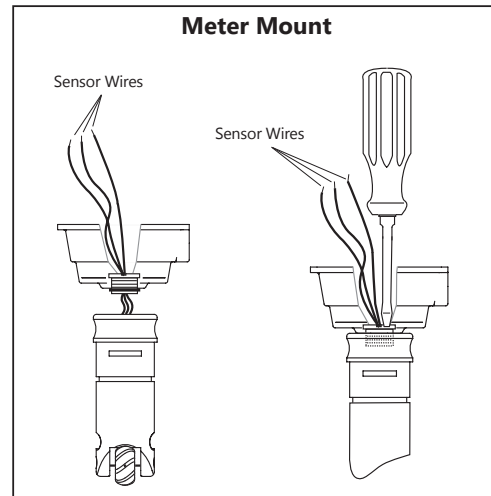
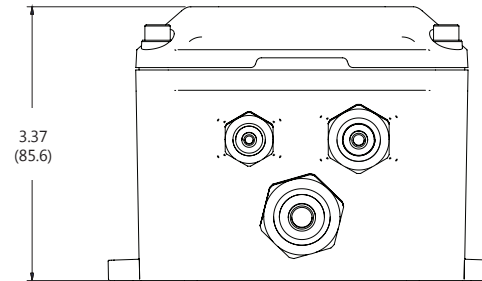

**Wall Mount.** To mount an FT430/440/450 indicator to the wall, hold the unit in the desired position, mark the holes in the mounting feet, drill and mount with screws. A meter-mounted indicator can be converted to a wall mount using an adapter mounting kit. Contact distributor for information.

**Meter Mount.** If the FT430/440/450 indicator was ordered as a meter mount model, the housing is already mounted directly to the flow sensor and needs no further installation.

An FT430/440 module can be converted from a wall-mount to a meter-mount using the mounting kit (contact distributor) that includes a lower housing and associated hardware and installs as follows:

1. Remove the strain relief through which the flow sensor cable runs.
2. Cut the cable to about 6" in length. Carefully strip the cable jacket to expose the three colored wires (red, white, and black) inside.
3. Route the wires through the threaded connector pre-installed in the bottom of the housing.
4. Start the threaded connector into the female thread on the top of the flow sensor. Be sure to match the oblong shape on the bottom of the housing to the depression on the top of the flow sensor.
5. Using an ordinary screwdriver inserted in one side of the slot (see drawing), tighten the screw as much as possible.
6. Strip the wire ends, make the connections to the indicator as shown in Connections Diagrams, and then use the cover screws to attach the indicator to the top of the housing.

**Panel Mount.** Using the "Panel Cutout" drawing as a guide, cut a hole in the panel. Place the FT430/440 indicator on the panel and mark the holes, drill, and mount with the supplied screws and washers.

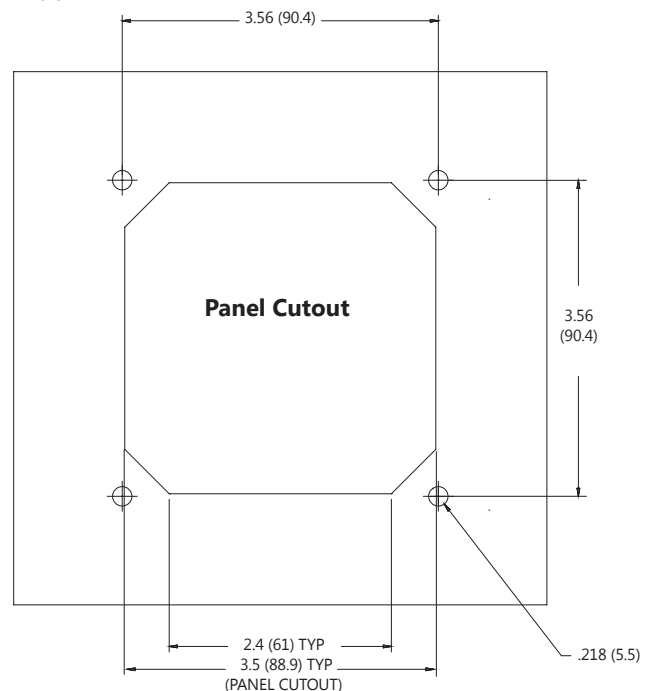

**Connections.** To connect the flow computer to a flow sensor or an external device such as a chemical metering pump, follow the Standard Connections diagrams on the following pages.

FT450 Standard Connections

**Caution:** Do not apply external power to the FT450.

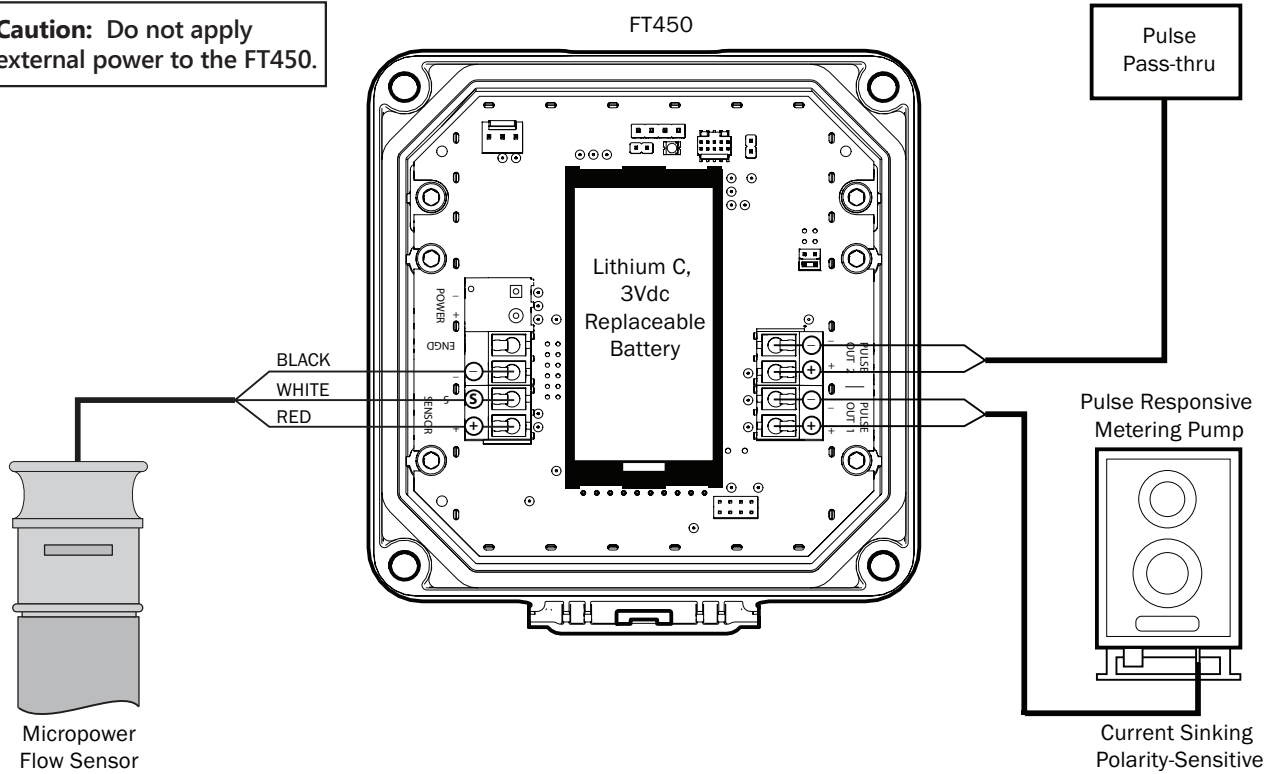

Connections for FT430/3-Wire Mechanical Meter

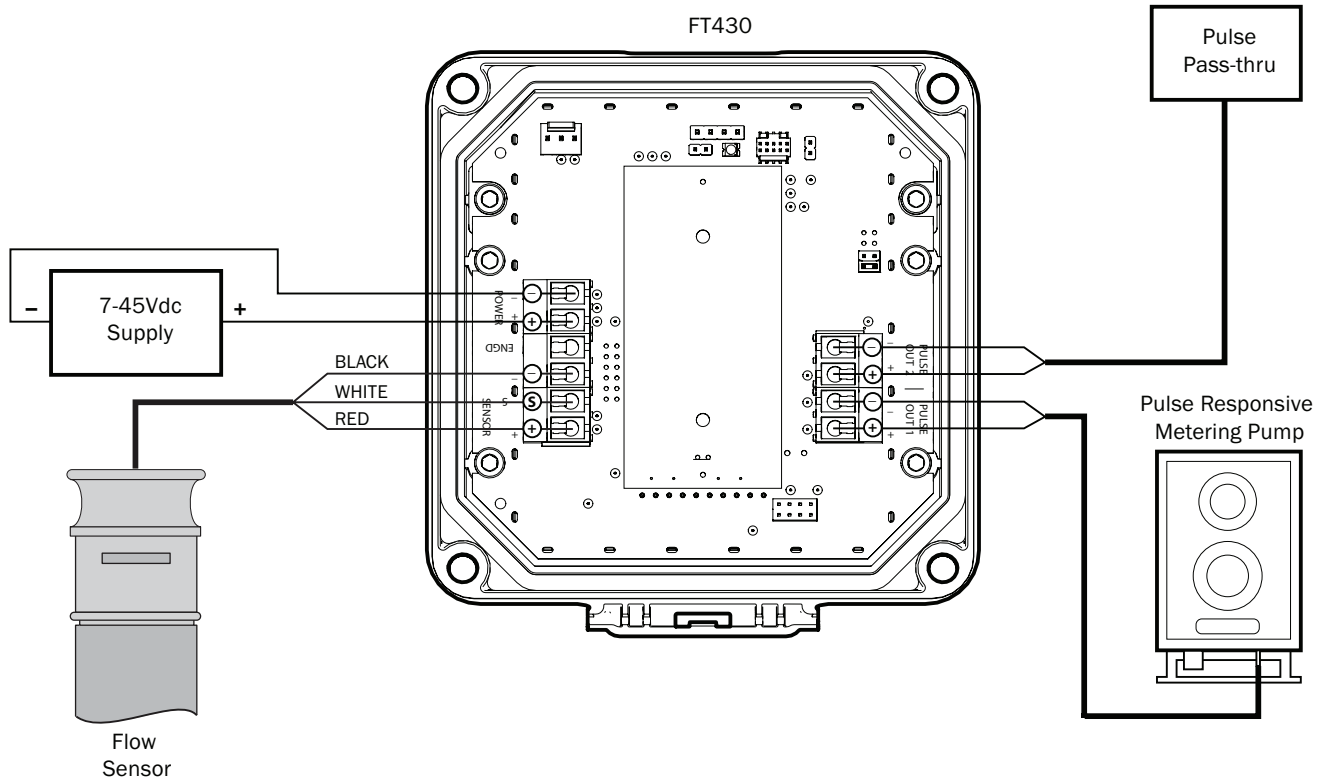

Connections for FT430-139 or FT440-139—115Vac Option

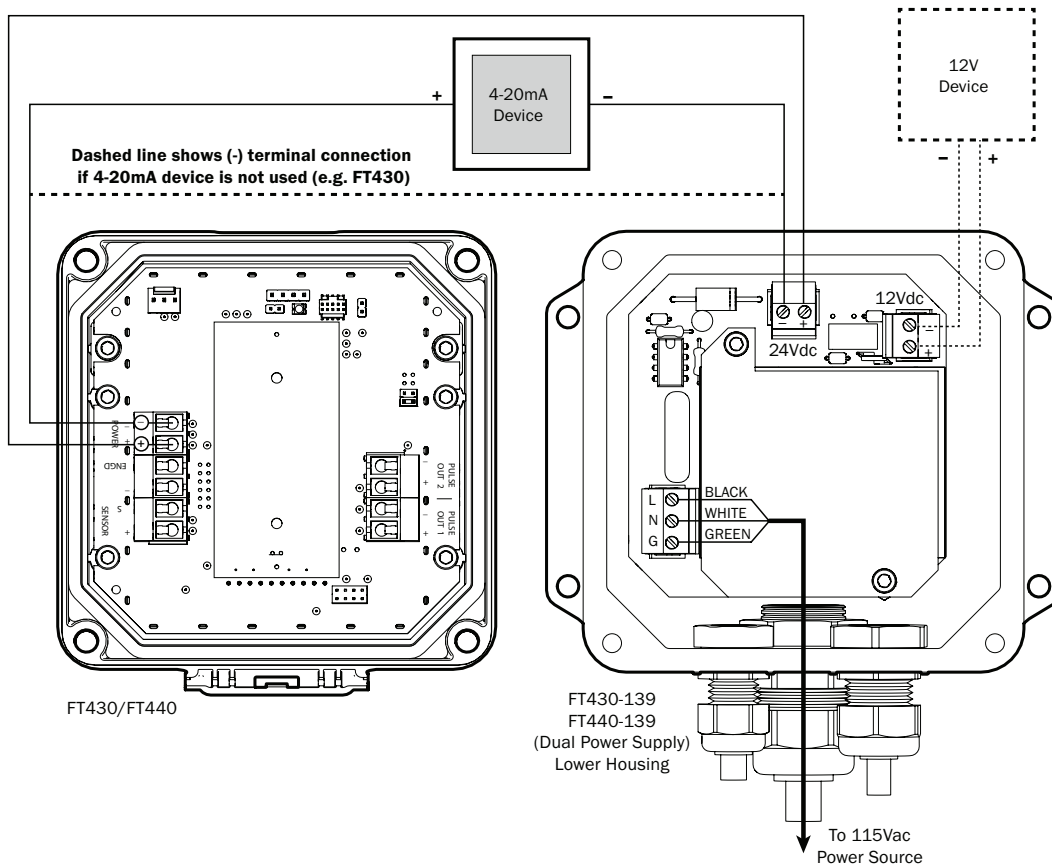

Connections for FT440/3-wire Mechanical/ Dual Scaled Pulse Out

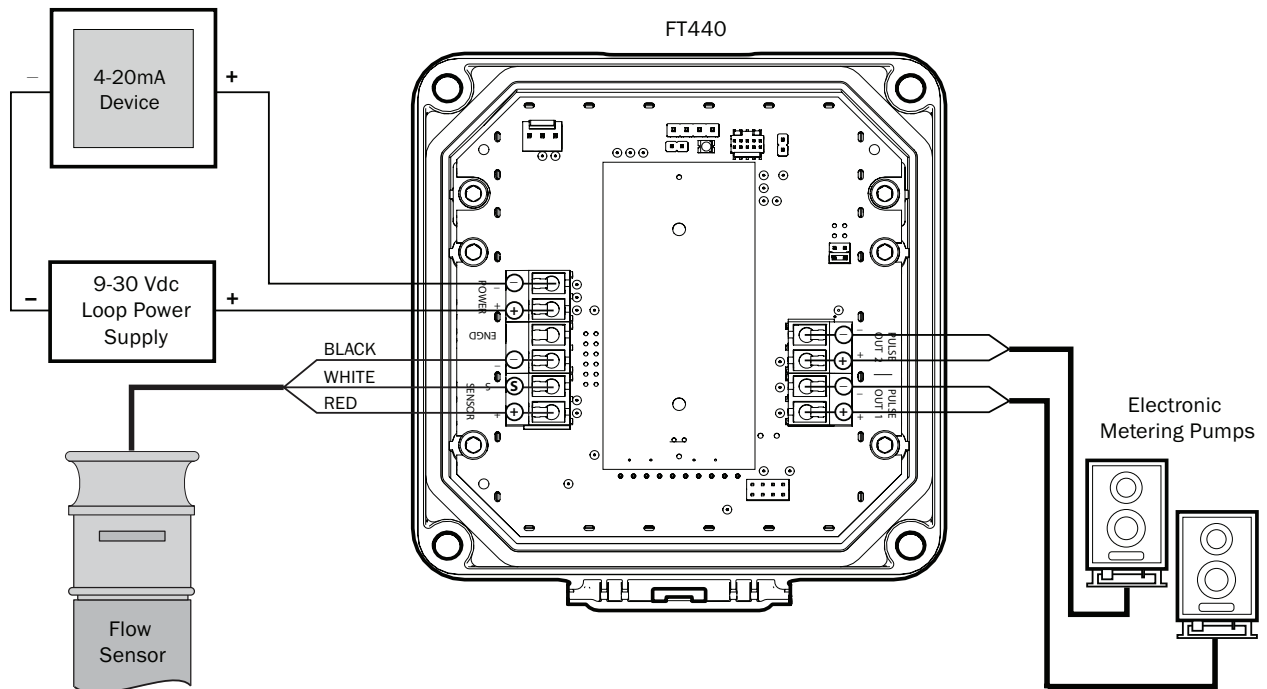

Connections for FT440/EX Magmeter

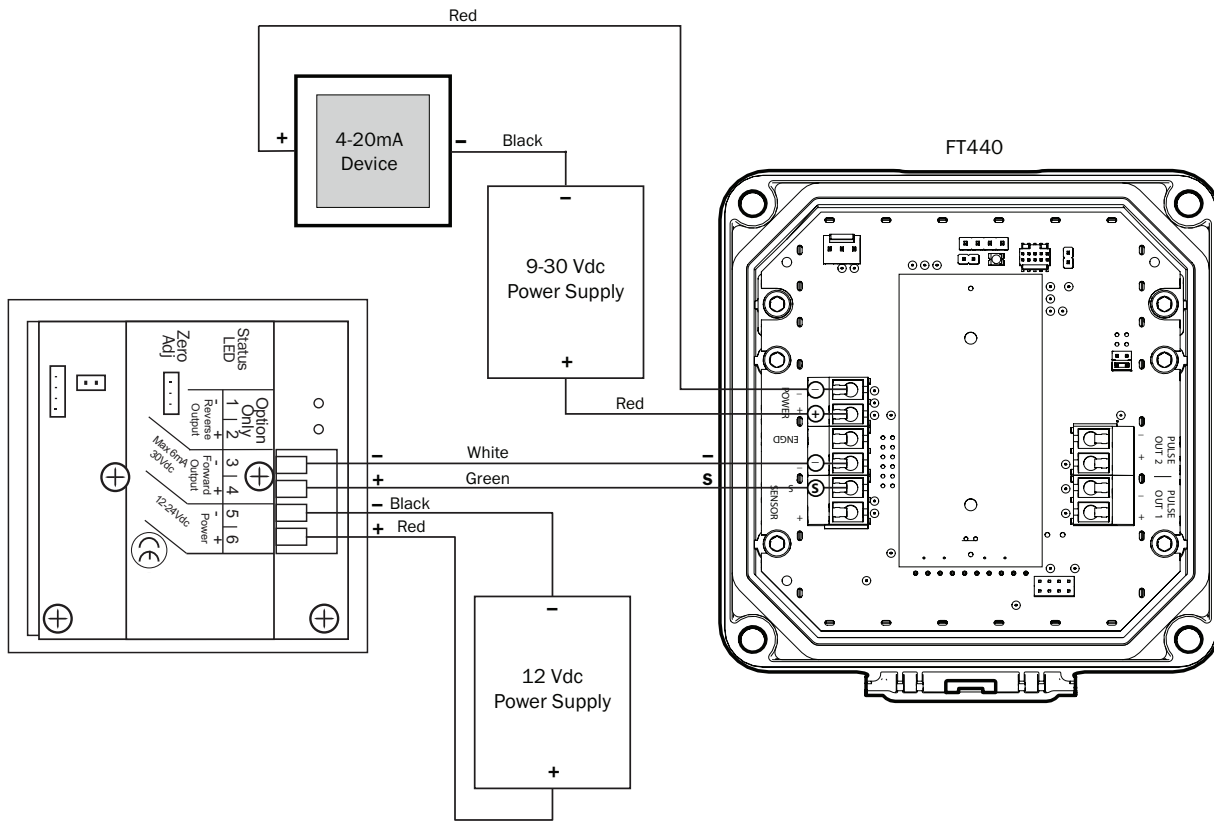

Connections for FT440-139/EX Magmeter

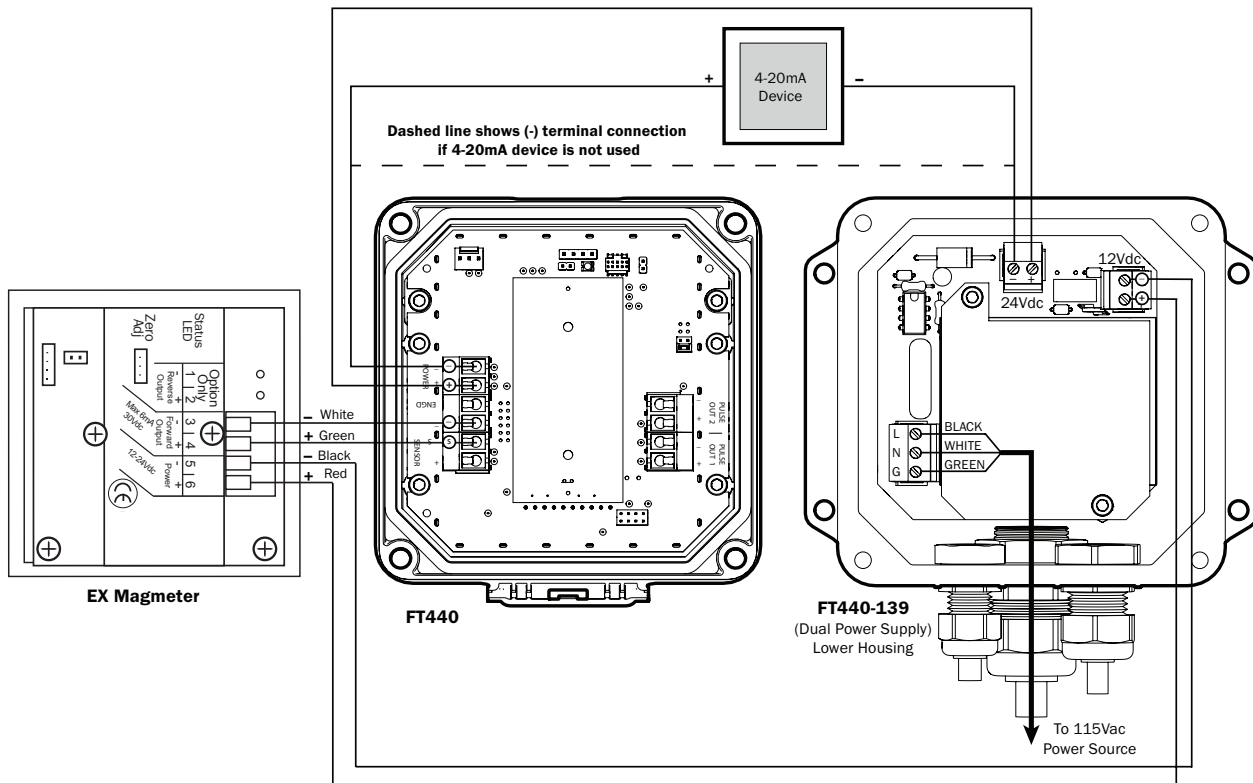



**K-Factor**

At a minimum, every FT430/440/450 flow computer must be programmed with the "K-factor". (This is the number of pulses that the meter produces per gallon of flow.) If you wish to read in units other than gallons, see below.

The K-factor on any Seametrics flow sensor fitting or in-line meter can be found on the model-serial label. The line reading K = xxxx gives the desired number. For depth-adjustable sensors (110, 210, 150, 250 models), use the calculator on our website.

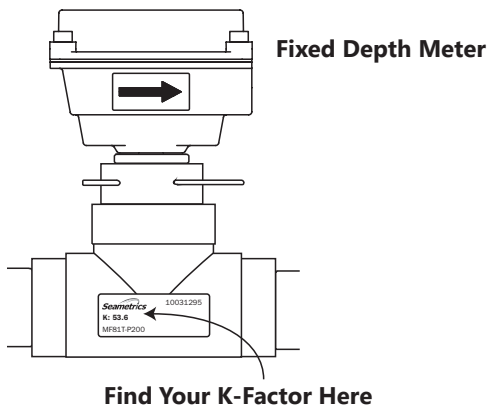

**Menu Navigation**



The left/right keys are used to move through the menus and position the cursor during data entry. The up arrow is used to scroll through the available values that are to be entered. (examples: numerical values for K factor entry or selection of units from the available options) The enter key (represented on the keypad by the check mark) is used to save selected entries and in conjunction with the exit tab to move between menu screens. As one navigates the menus the current parameter setting is shown and instructions are displayed for how to change the selected parameter.

**MAIN MENU**

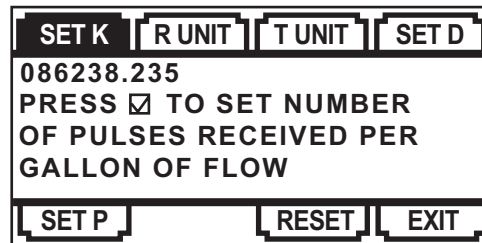

All menu screens consist of two rows of tabs surrounding a dialog box that lets you view and change setup parameters.

**SET K**

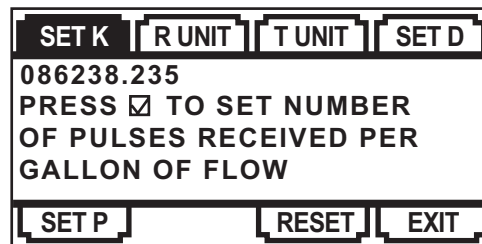

View or change the K factor. The K factor is the number of pulses the flow sensor provides for every gallon of flow. (Note that the decimal is fixed at three places. If you only have two decimal places for your K-factor, enter a zero for the third digit. If unable to set K-factor, the unit is "locked" to prevent tampering. Please contact your distributor for assistance.)

**R UNIT**

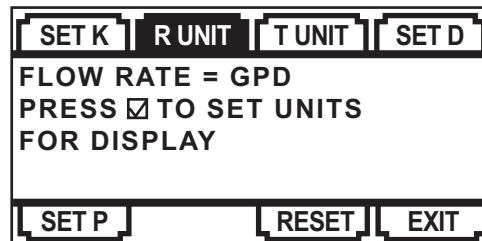

View or change the flow rate units

**Changing Flow Indicator Settings**

**THE HOME SCREEN**



The HOME Screen, shown above, is the normal screen which displays TOTAL flow volume and flow RATE. The Four buttons below the LCD display are used to access menu screens for viewing and changing setup parameters.

**T UNIT**

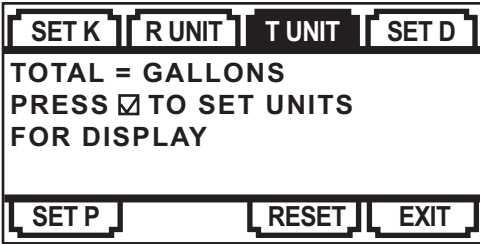

View or change the total volume units

**SET D**

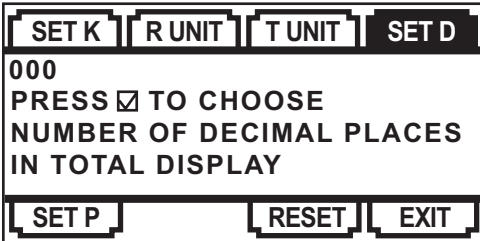

View or change the number of decimals displayed in the total volume display

**SET P OR SET A**

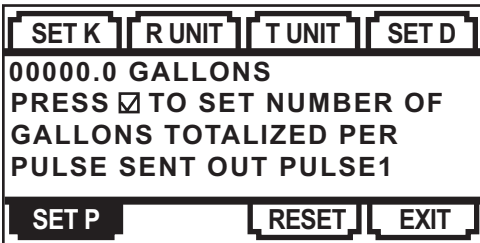

The factory setting will show Set P which allows one to view or change the volume of flow totalized per pulse sent to pulse out 1. The units for Set P follow the units selected for the rate display. *(With EXIT highlighted, pressing the up arrow four times will allow pulse out 1 to be an alarm. The alarm can be set to trigger on either a high or low flow condition as determined by the user.)*

**SET 20 (FT440 ONLY)**

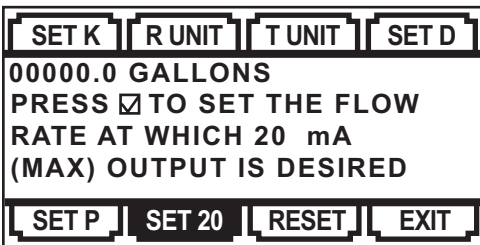

Input the flow rate at which 20 mA (max) output is desired

**RESET**

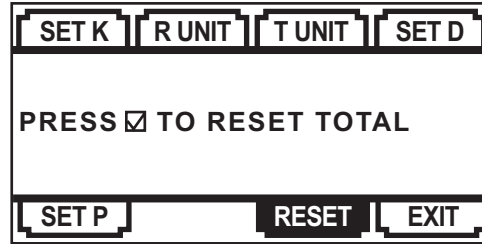

Reset the total flow volume to zero. This tab is not available when the -64 non resettable total option is ordered

**EXIT**

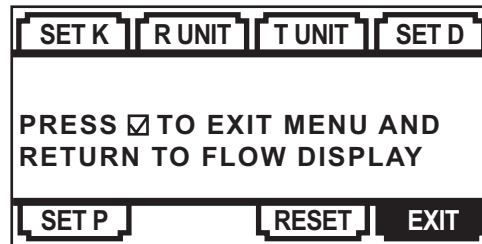

Return to the home screen, enter a submenu, or accept a parameter change

The Exit menu also allows access to the secondary menu, as described on the next page.



**NOTE:** To conserve battery life on battery powered units, the display screen goes into sleep mode (black screen) after approximately 3 minutes of non-use. Push any button to reactivate display.

**The FT440 Secondary Menu Functions**

When using the FT440, a secondary menu is available with further options. Enter the secondary menu by pressing the up arrow four times while EXIT is highlighted.

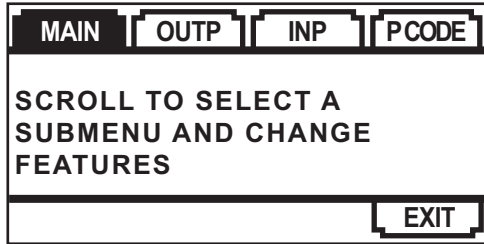

**OUTP**

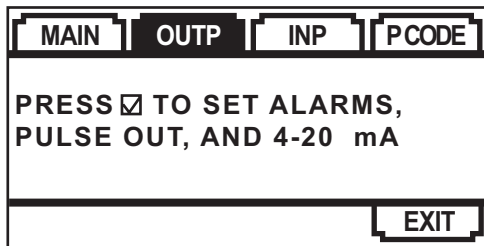

View or change the function of Set P tab on the main menu.

The P/A tab changes the function of the outputs. Default is scaled pulse out for both outputs. Either output can be changed to alarm high or alarm low. If alarm options are selected menu tabs for setting the alarms will be displayed on the main menu (alarm 1) or the secondary menu (alarm 2) If the alarm options are selected a Set H (hysteresis) tab is available. The hysteresis entry is a % value. The value defines the % change required for a change in alarm state to occur.

The factory setting will show Set P2 which allows one to view or change the volume of flow totalized per pulse sent to pulse out 2. The units for Set P2 follow the units selected for the rate display. If P2 is selected as an alarm the menus will change to Set A2 and a Set H (hysteresis) tab is available. The hysteresis entry is a % value. The value defines the % change required for a change in alarm state to occur.

Set 4 input the flow rate at which 4 mA (min) output is desired.

ADJ L allows the adjustment of the 4 mA and 20 mA values so that one can tune performance of the FT440 to match the installed system values. The adjustment units range from 0-32. Positive values adjust the setting incrementally larger and negative values adjust the setting incrementally lower.

**INP**

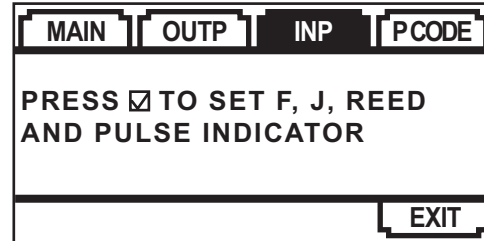

View or change the filter (set F), jitter (set J), enable reed mode. Use the filter setting if the display is jumping excessively due to flow conditions. Use the jitter setting to enter a time delay to handle start up conditions. Jitter units are seconds.

**PCODE**

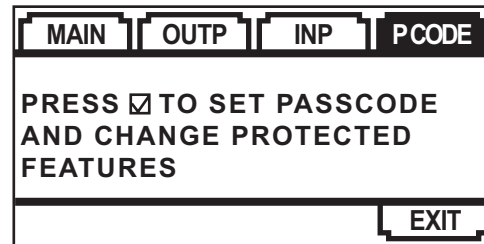

Enter the pass code for access to protected features.

**Protected Features**

To enter the protected features use the left/right arrow keys to navigate to the Pcode tab, found in the secondary menu. Press the enter key and then enter the pass code. The protected menu, shown below, will now be displayed. The tabs have the following functions:

- Set CD** Enter a user created numerical pass code.
- Lock** Lock menu functions to prevent unauthorized changes.
- E/D R** Disable or enable the total volume reset function.
- PCNT** Keeps a running tally of the number of times the pass code has been used.

## TROUBLESHOOTING

Problem	Probable Causes	Things to try...
Display blank	No power to the unit Short in sensor circuit Battery dead or loose (FT450 only) Display is in sleep mode	Check for minimum 12 Vdc at power terminals Disconnect sensor, see if display returns (zero flow rate) Wiggle battery, replace if over three years old Push any button to reactivate display. (Display goes to sleep after about 3 minutes of non-use.)
Display missing pixels	Damaged display module	Contact distributor for return/replacement
Display showing meaningless characters	Unit's microcontroller crashed Battery nearly dead	Disconnect and reconnect power. If problem repeats, contact distributor for return/replacement. Replace battery
Display reads normally but flow rate incorrect	Wrong K-factor or time base entered	Enter correct K-factor from meter, fitting, or manual
Display reads normally but incorrect pulse output	Wrong pulse output setting Polarity reversed on pulse output terminals	Use "Set P" to correct pulse output setting Reverse leads
Display reads normally, but no (or incorrect) 4-20mA output (FT440 only)	Wrong 4mA setting or wrong 20mA setting Inadequate loop power supply voltage Polarity incorrect in 4-20mA loop circuit	Use "Set 4" to correct target minimum flow rate. Use "Set 20" to correct target top flow rate. Check voltage (For 4-20mA applications, 24 Vdc is recommended) Compare to Connections diagram
Display reads zero when there is flow	Flow sensor failed Break in flow sensor circuit Flow sensor not battery-compatible	Consult flow sensor manual for how to test Check for continuity with multimeter Check flow sensor model number for "micropower option"
Display reads flow rate when there is none	Long flow sensor wire, running parallel to power wires Flow sensor malfunction Flow "jitter" (oscillating slosh) reads as flow	Reroute wire or change to shielded wire See flow sensor manual to check Consult factory for "anti-jitter" setting
Totalizer does not always appear to display the total flow	Break in power to meter	The totalizer's memory is only updated every 15 minutes. If power is lost, the totalizer will retain the value last written but will not be updated to reflect any flow between the last write and the time the power was lost.

