

RR4-TR Remote Reader

With Integrated NextCentury Transceiver (Radio)

Operation and Installation Guide



1| Product Overview

The NextCentury RR4-TR Remote Reader is an advanced meter reading solution which provides a high visibility remote display of one or two utility meters.

The Remote Reader has an attractive consumer design, making it an ideal solution for apartment or commercial metering. The utility and unit of measure are clearly displayed, ensuring an accurate interpretation of the read. It is NTEP certified and can be used to meet tenant meter read requirements.

In addition to displaying the meter read, the RR4-TR Remote Reader operates as a wireless transceiver end-point, transmitting meter read data to the NextCentury cloud platform.

The Remote Reader utilizes **Dual Meter+**TM technology, making this single model compatible with virtually all modern encoded and pulse-output utility meters, including water, electric, gas, and thermal meter models.

2| Technical Specifications

2.1 – Certifications

FCC: 2AB8I-RR4 IC: 20949-RR4
NTEP: 20-012 IP-Rating: IP66

2.2 – Wireless

- Two-way NextCentury RF ConnectTM
- 902-928 MHz Unlicensed Band

2.3 – Dual Meter+TM

- Any combination of two encoded or pulse-out meters
- Or, single meter pulse-in and pulse-out

2.4 – Wireless Configuration

- Direct Connect or Cloud configure (see section 6)
- Pre-programming available

2.5 – Battery

- Preinstalled, field replaceable CR18505
- Up to *10-year battery life

**Note: 10-year battery life calculated and tested at typical operating temperatures between 60°F-90°F and a 6-hr device check-in. Achieved battery life can be greater or less than 10 years depending on the meter type(s), system configuration, and lifetime operating temperature.*

2.6 – Dimensions:

- Display unit and mounting plate: 5.7" x 4.6" x 1.7" (145mm x 117mm x 44mm)
- Mounting holes center-to-center: 3.5" (88.4 mm)
- Compatible with a standard single gang wall-box

2.7 – Operation Environment:

- -20°C to 60°C (-4°F to 140°F)
- Indoor or Outdoor (IP 66, non-submersible)

3| Meter Compatibility

The NextCentury Remote Reader integrates **Dual Meter+**TM technology, allowing for compatibility with virtually all modern meter outputs.

3.1 – Pulse Output Meters

- Passive pulse sensing (including reed switch, solid-state relay, contact relay, open-drain types)
- Active voltage sensing (max. 16 VDC)

3.2 – Encoded Output Meters

- Neptune (including ProRead, ECoder, and ProCoder register models)
- Sensus UI-1203 (includes most meter models from Sensus, Hersey, Mueller, Master Meter, Badger, Kamstrup, Elster, Metron-Farnier, and Zenner)
- Elster/AMCO K-Frame (includes most meter models from Elster, AMCO, ABB and Kent)
- GWF ECO (Unico, Unico2coder)

4| Packaging Contents

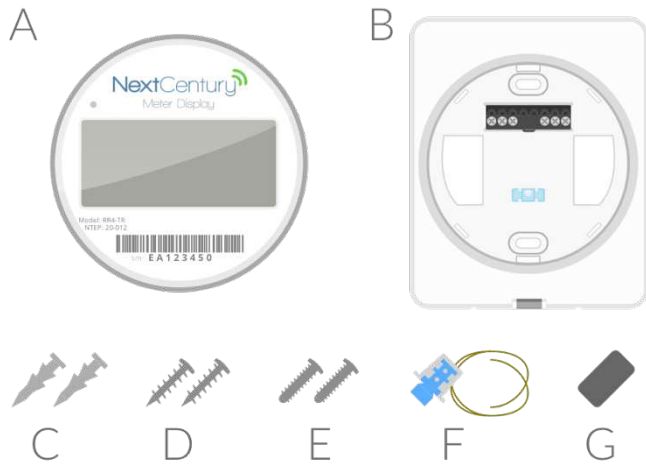

- A - RR4-TR Remote Reader
- B - Mounting Plate
- C - Sheetrock Anchors
- D - Wall Mount Screws #6-20
- E - Box Mount Screws #6-32
- F - Wire Security Assembly
- G - Activation Magnet (one per case)

5| In-Field Installation



5.1 – Detach from Mounting Plate

- Pull down the security tab, the Remote Reader can then be pulled off the mounting plate.
- Slide the security tab back to its original position when installation is complete.

DO NOT open the Remote Reader unless replacement of the battery is necessary (approx. every 10 years). It is not necessary to disassemble/open a Remote Reader during installation.

5.2 – Mounting Plate Installation

- Hold the mounting plate at the desired height and use the integrated level to straighten
- Use a pencil to mark holes for pre-drilling
- Pre-drill using a 7/32" (5.5mm) drill bit
- Insert plastic anchors and attach the mounting plate with a PH-1 screwdriver and the two screws (fig. 4-D)

5.3 – Wall Box (optional)

- Pass the meter wire(s) through the mounting plate access holes
- Use a PH-1 screwdriver and the two screws (fig. 4-E) to attach the mounting plate

5.4 – Meter Wiring

The Remote Reader can be connected to one or two meters. Use Meter 1 (left 3 terminals) and Meter 2 (right 3 terminals) to connect meters to the Remote Reader's mounting plate.

- Strip meter wire ends to 3/16" (5 mm)
- Insert the wire ends into the terminal block and tighten securely using a PH-1 screwdriver

5.5 – Meter Wiring Diagram

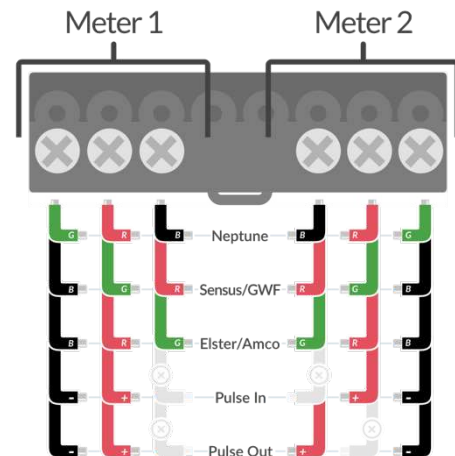

5.6 – Tamper Evident Seal

- The Security Wire Seal (figure 4-F) can be used according to your installation specifications.

6| Configuration Programming Methods

6.1 – Direct Connect Using Mobile Device

Using the NCSS Mobile App, your Android or iOS mobile device can communicate directly with the Remote Reader in order to set the configuration (see section 7).

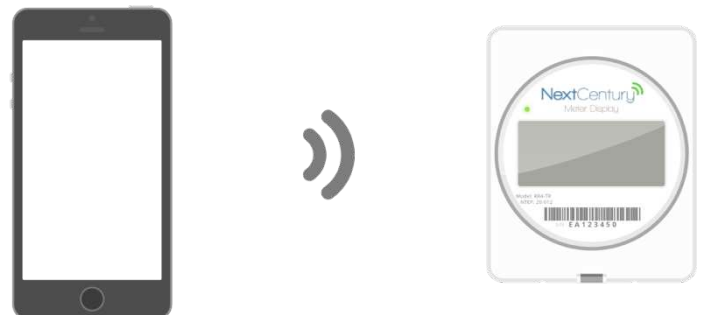

6.2 – Cloud Configuration

The Remote Reader can also receive a configuration that has been programmed on the NextCentury website. This method can be used when a cloud-connected Gateway and Repeaters have already been installed (see section 8).



6.3 – Magnet Activation

Device activation is performed by swiping a magnet past the right side of the Remote Reader.

- The Remote Reader will now be available to Direct Connect to your mobile device (see section 7)
- The Remote Reader will check-in to a programmed Gateway (see section 8)

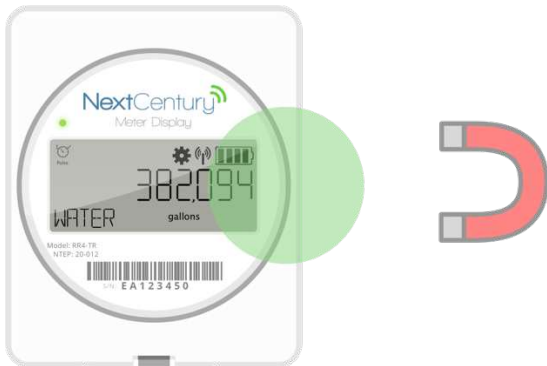

A magnet is moved past the activation zone highlighted above.

7| Direct Connect Configuration

7.1 – Mobile App

The NCSS Mobile App allows technicians to connect wirelessly to the Remote Reader to set the configuration. This includes:

- Configuring for the meter's unit of measure and multiplier
- Selecting the utility type
- Entering an initial meter read (pulse meters)
- Clearing a tamper alert

7.2 – Download

The NextCentury Submetering Solutions “NCSS” Mobile App can be found on the Google Play or App Store.



7.2 – Direct Connect Tool

The Direct Connect tool allows your mobile device to communicate directly with the Remote Reader.

- Log in to the mobile app and navigate to the Direct Connect tool
- Swipe a magnet past the Remote Reader's activation zone – a gear icon will appear on the display
- The Remote Reader will appear on the app and can be selected in order to configure

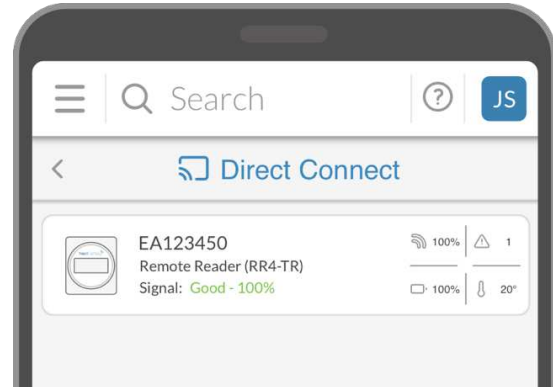

The Remote Reader is selected on the mobile app and configuration changes can then be made.

8| Cloud Configuration

8.1 – Website Management

The NextCentury website facilitates the cloud management of equipment installed at a property. Equipment including the Gateway, Repeaters, and the Remote Readers are programmed on the web interface as a part of installation.

Visit support.nextcenturymeters.com for additional information regarding property setup.

8.2 – Programming

- Program the Remote Reader on the website with the applicable meter configuration.
- The cloud-connected Gateway will send this configuration to the Remote Reader when it next checks in.

8.3 – Initiating Wireless Check-In

- A wireless check-in is initiated using a magnet within the magnetic activation zone
- The Remote Reader will blink green indicating it received a response from the Gateway
- If configuration changes were made using the website, they will now be applied by the Remote Reader

8.4 – LED Indicator

The LED indicator provides feedback to easily check the status of the RR4-TR.

- 8x Checking In (red)
- 1x Meter 1 Pulse (blue)
- 2x Response Received (green)
- 1x Meter 2 Pulse (purple)

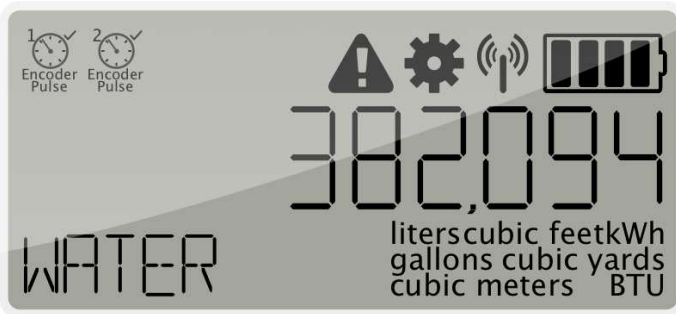

9| LCD Display

9.1 – LCD Options



9.2 – Meter Display Views

The Remote Reader will cycle through the following views at a 5-10 second interval (as applicable to its configuration).

- 
Meter 1
 - Meter read, utility, unit of measure (UoM)
 - Meter read, UoM, serial number (encoded)
- 
Meter 2
 - Meter read, utility, UoM
 - Meter read, UoM, serial number (encoded)

9.3 – Event Count





The Remote Reader maintains a lifetime count of all configuration change instances.

The event count is displayed every 5th meter view (previous section). Example: displays as “Event 0001”.

9.4 – Alerts

The Remote Reader displays an icon for active alerts. Freeze, leak, and low battery alerts are cleared automatically when the alert condition is no longer true.

Note: Tamper Alerts must be cleared manually using the mobile app (see section 7).

- 
Tamper
 - Tamper Alert: device has been removed from mounting plate
- 
 - Leak or Freeze Alert: a leak or freezing temperatures currently detected
- 

 - Low Battery Alert: replacement needed (less than 4-6 months remaining)

9.5 – Radio Signal-Strength

An RF indicator icon will appear immediately after the Remote Reader checks in. This indicator provides quick feedback to a technician of network signal strength.

- 
Radio Indicator
 - Displays 1-3 bars based on the most recent check-in.

9.6 – Utility Types

The configured utility type is shown on the bottom left of the display.

- All Water
- Cold Water
- Hot Water
- Commercial Water
- Gas
- Electric

9.7 – Units of Measure

The configured unit of measure is shown on the bottom right of the display.

- gallons (water)
- liters (water)
- cubic feet (water, gas)
- cubic yards (water, gas)
- cubic meters (water, gas)
- kWh (electric)
- Wh (electric)
- BTU (thermal)

10| Television and Radio Interference

NOTE: This equipment has been tested and found to comply with the limits for a Class B digital device, pursuant to part 15 of the FCC Rules. These limits are designed to provide reasonable protection against harmful interference in a residential installation. This equipment generates, uses and can radiate radio frequency energy and, if not installed and used in accordance with the instructions, may cause harmful interference to radio communications. However, there is no guarantee that interference will not occur in a particular installation. If this equipment does cause harmful interference to radio or television reception, which can be determined by turning the equipment off and on, the user is encouraged to try to correct the interference by one or more of the following measures:

- Reorient or relocate the receiving antenna.
- Increase the separation between the equipment and receiver.
- Connect the equipment into an outlet on a circuit different from that to which the receiver is connected.
- Consult the dealer or an experienced radio/TV technician for help.

The FCC requires the user to be notified that any changes or modifications made to this device that are not expressly approved by Company Name may void the user’s authority to operate the equipment.

Radiation Exposure Statement:

This equipment complies with FCC radiation exposure limits set forth for an uncontrolled environment. This equipment should be installed and operated with minimum distance 20cm between the radiator & your body.

As per 47 CFR §15.19

(All other devices shall bear the following statement in a conspicuous location on the device:

This device complies with part 15 of the FCC Rules. Operation is subject to the following two conditions: (1) This device may not cause harmful interference, and (2) this device must accept any interference received, including interference that may cause undesired operation.

As per 47 CFR §15.21

The user's manual or instruction manual for an intentional or unintentional radiator shall caution the user that changes or modifications not expressly approved by the party responsible for compliance could void the user's authority to operate the equipment. In cases where the manual is provided only in a form other than paper, such as on a computer disk or over the Internet, the information required by this section may be included in the manual in that alternative form, provided the user can reasonably be expected to have the capability to access information in that form.

ISED Statement

This radio transmitter (identify the device by certification number) has been approved by Industry Canada to operate with the antenna types listed below with the maximum permissible gain indicated. Antenna types not included in this list, having a gain greater than the maximum gain indicated for that type, are strictly prohibited for use with this device.

Immediately following the above notice, the manufacturer shall provide a list of all antenna types approved for use with the transmitter, indicating the maximum permissible antenna gain (in dBi).

8.4 User Manual Notice for Licence-Exempt Radio Apparatus

User manuals for license-exempt radio apparatus shall contain the following text, or an equivalent notice that shall be displayed in a conspicuous location, either in the user manual or on the device, or both:

This device complies with Innovation, Science and Economic Development Canada's licence-exempt RSSs. Operation is subject to the following two conditions:

- (1) This device may not cause interference; and*
- (2) This device must accept any interference, including interference that may cause undesired operation of the device.*

Cet appareil est conforme aux flux RSS exemptés de licence d'Innovation, Science et Développement économique Canada. L'opération est soumise aux deux conditions suivantes:

- (1) Cet appareil ne doit pas provoquer d'interférence; et
- (2) Cet appareil doit accepter toute interférence, y compris les interférences susceptibles de provoquer un fonctionnement indésirable de l'appareil.

ISED Radiation Exposure Statement

[English] Radiation Exposure Statement: This equipment complies with the IC RSS-102 radiation exposure limits set forth for an uncontrolled environment. This equipment should be installed and operated with a minimum distance of 20 cm between the radiator and your body.

[French] Énoncé d'exposition aux rayonnements: Cet équipement est conforme aux limites d'exposition aux rayonnements ioniques RSS-102 Pour un environnement incontrôlé. Cet équipement doit être installé et utilisé avec un Distance minimale de 20 cm entre le radiateur et votre corps.

10| Warranty/Disclaimer Scope of Warranty

NextCentury warrants that all communication equipment manufactured by NextCentury will be free from defects in materials and workmanship under normal use and in accordance with NextCentury's documented installation and operating procedures for a period of three (3) years from the date of manufacture.

Products not manufactured by NextCentury, including without limitation, accessories, attachments, meters, or batteries used in conjunction with NextCentury equipment are warranted, if at all, only by the original manufacturer. NextCentury's warranties do not include replacement of batteries used to power NextCentury products.

Limits of Liability

This warranty only applies to Read Management System components produced by NextCentury, and does not cover any products which have been damaged by misconduct, negligence, vandalism, acts of God, excessive operating conditions, or unauthorized attachments or modifications. This warranty will be null and void if products are placed in non-recommended installation application/fashion, or are converted, altered, or treated by other than NextCentury recommended procedures and instructions, or are read by equipment not approved by NextCentury.

NextCentury's liability and customer's exclusive remedy under this warranty is expressly limited to repair or replacement of the product at

NextCentury's option, and is conditioned upon the customer returning the product(s) to the location designated by NextCentury within the warranty periods or limits stated herein, and pre-paying the freight costs both to and from specified location. In no event shall NextCentury be liable for costs or expenses associated with the removal or installation of products under this warranty.

NextCentury shall have no liability or responsibility to the purchaser or any third party for any loss, cost, expense, damage, or liability, whether direct or indirect, or for special, incidental, indirect, or consequential damages of any kind, regardless of whether such liability is based on breach of contract, tort, strict liability, breach of warranties, or otherwise, and even if advised of the likelihood of such damages. Incidental and consequential damages include, but are not limited to, lost revenue, loss of profits, data, business, or goodwill. In addition, damages resulting from negligence on the part of the customer, including, but not limited to, the care and maintenance of NextCentury products or damages resulting from negligence regarding periodic testing of the product's performance, are not covered under this guarantee.

CHANGES OR MODIFICATIONS NOT EXPRESSLY APPROVED BY NEXTCENTURY MAY VOID THIS WARRANTY AND THE USER'S AUTHORITY TO OPERATE THE EQUIPMENT.

THE FOREGOING WARRANTY IS THE SOLE AND EXCLUSIVE REMEDY AVAILABLE TO THE PURCHASER AND IS IN LIEU OF ALL OTHER WARRANTIES, GUARANTEES, OR REMEDIES, WHETHER WRITTEN OR ORAL, EXPRESS OR IMPLIED, INCLUDING WITHOUT LIMITATION, THE IMPLIED WARRANTIES OF MERCHANTABILITY AND FITNESS FOR A PARTICULAR PURPOSE, ALL OF WHICH NEXTCENTURY HEREBY EXPRESSLY DISCLAIMS.

Due to updated regulations and product improvements, NextCentury Submetering Systems, LLC reserves the right to change the product specifications without notice.

11| Additional Resources



For additional resources, please visit:

products.nextcenturymeters.com/rr4-tr

Product Support:

Phone: (844) 538.8203

Email: support@nextcenturymeters.com
